



Stage 1

ALL ACCESS!

© 1992 FASA CORPORATION

## CONTENTS

# CONTENTS

<b>THE PRICE OF BUSINESS: A Prologue</b>	4	<b>The Shadows</b>	60
<b>INTRODUCTION</b>	5	Marli Bremerton	60
<b>Gamemastering Notes</b>	5	Joey Nightmare	60
Shadowrun Rules	5	Sid Id	60
Making Success Tests	5	Ernest Hawkins	60
Success Tables	5	<b>PLAYER HANDOUTS</b>	62
<b>How to Use This Book</b>	5		
Preparing the Adventure	6		
<b>Plot Synopsis</b>	6		
<b>THE ADVENTURE</b>	8		
<b>Meet Mr. Johnson</b>	8		
<b>Walk In the Park</b>	10		
<b>Face to Face</b>	11		
<b>The Fed</b>	13		
<b>Armed and Dangerous</b>	14		
<b>Going to the Mattresses</b>	16		
<b>Brutal Ambush</b>	20		
<b>Off On A Tangent</b>	23		
<b>It's My Party</b>	24		
<b>Under Surveillance</b>	28		
<b>The Nightstalkers</b>	29		
<b>Mindfield</b>	31		
<b>Wallace Again</b>	35		
<b>Charon</b>	36		
<b>Aid From the Vampire</b>	38		
<b>Shadows In the Shadows</b>	40		
<b>Final Assault</b>	41		
<b>PICKING UP THE PIECES</b>	46		
<b>If the Team Succeeds</b>	46		
Jetblack And The Shadows	46		
<b>If the Team Falls</b>	47		
<b>Karma</b>	47		
<b>LEGWORK</b>	49		
<b>Electronic Legwork</b>	49		
<b>Highstar Incorporated</b>	50		
<b>Caravan</b>	50		
<b>Allenby</b>	50		
<b>Teague</b>	50		
<b>Meta</b>	51		
<b>The Shadows</b>	51		
<b>Jetblack</b>	51		
<b>Wallace and the FBI</b>	51		
<b>The Nightstalkers</b>	52		
<b>Teague's Vashon Island Home</b>	52		
<b>Hard Corps Security Inc.</b>	52		
<b>CAST OF SHADOWS</b>	53		
<b>Jonathon Teague</b>	54		
<b>Lew Allenby</b>	55		
<b>Wallace</b>	56		
<b>Meta</b>	57		
<b>Jetblack</b>	58		

### ONE STAGE BEFORE

#### Writing

Nigel Findley

#### Development

Tom Dowd

#### Editorial Staff

*Senior Editor*

Donna Ippolito

*Assistant Editor*

Sharon Turner Mulvihill

*Editorial Assistant*

Diane Piron

#### Production Staff

*Art Director*

Jeff Laubenstein

*Project Manager*

Joel Biske

*Cover Art*

Doug Andersen

*Cover Design*

Joel Biske

*Illustration*

Dan Smith

Janet Aulisio

Joel Biske

Jim Nelson

*Layout*

Tara Gallagher

*Keyline and Pasteup*

Ernie Hernandez

SHADOWRUN, MATRIX and ONE STAGE BEFORE are trademarks of FASA Corporation. Copyright © 1992 FASA Corporation. All Rights Reserved. Printed in the United States of America. Published by FASA Corporation • P.O. Box 6930 • Chicago, IL 60680



# THE PRICE OF BUSINESS

"No! I said no, and I mean no. Your offer's drek, and you're drek. I'm not selling. Go frag yourself!" Allenby punched the Disconnect key on his telecom almost hard enough to crack the reinforced plastic. He clenched his small fists so hard that his knuckles stood out like ivory, and the tendons ached in his forearms. He spun in his swivel chair and fired a hard punch into the wall behind him, adding another fist-sized dent to the light construction plastic. The three framed platinum discs on the wall jumped, but didn't crash to the floor this time. Fragging Teague, he raged mentally. "Tangent! Get in here!"

No one moved in the outer office. He knew Tangent was there; she was giving him a few minutes to calm down. *It's not her fault*, he reminded himself. *Don't take it out on her.*

Slowly, cautiously, his office door swung open. Tangent stuck her head into the office, her mane of golden hair framing a worried face. "Yes, boss?"

With a monumental effort, Allenby forced himself to speak calmly. He laid his hands palm down on the desk, his arms quivering with the strain of *not* throwing his mug of soykaf at the wall. "Tangent," he said as quietly as he could, "you will *not* accept any more calls from Jonathon Teague, or from Highstar Incorporated. *None*. Do you understand me?"

Tangent blinked. "But he said you'd want to talk to him—"

Allenby cut her off harshly. "Read my lips. *No...more...calls*. Scan me?"

"I..." Tangent swallowed hard, her face pale under her make-up. "I'm sorry, boss, I didn't mean to—"

Allenby cut her off again with a wave of his hand. "Don't sweat it, you didn't know." He watched his secretary's face brighten a little. *Got to go easier on the kid*, he told himself. "Now come in here and sit down."

As Tangent settled herself in the guest chair in front of his huge desk, Allenby turned to stare out the window. He could see the sun setting over the docks, a swollen red ball distorted by the devil's-brew of drek in the air. Fragging Teague, he thought again. He forced himself to take a few deep breaths, to flush away the anger he still felt. He turned back to Tangent. "Tell me about The Shadows' show."

Tangent glanced down at her pocket secretary. "Everything's on schedule," she said. "Twelve days to the show. The Kingdome's booked and confirmed..."

"Cancellation insurance?" Allenby snapped.

"Taken care of," Tangent shot back. "The dome's ours. I've booked security—"

"Knight Errant again?"

Tangent shrugged. "They're the only ones who can handle something this big."

"I guess," Allenby grumbled. "Go on."

"Transport for the equipment, limos for the band—all set." She smiled at him. "The show's a go."

He could sense her excitement; he had to admit he felt it himself. He'd been in the music biz for almost twenty years now—*Twenty? Was it really that long?*—and he'd managed some of the biggest names. About the only megastar group he hadn't managed to work with was Concrete Dreams. *And if this comes off, they'll be begging me to handle their next gig*, he thought. He'd put on some of the biggest shows the sprawl had ever seen. But *this* one would dwarf them all.

He had The Shadows, the hottest band to hit the music biz since Jetblack died. Their newest disk or chip always sold out within two days. Secondary marketing—T-shirts, posters, that kind of drek—netted more each year than most bands grossed in their entire career. The Shadows were *it*. And he, Allenby, managed them.

"How about ticket sales?" he asked.

Tangent didn't need her pocket secretary to field that one. "Boss, this show sold out five weeks back within an hour of going on sale." She grinned. "The scalpers are making a killing."

"What's the street price?"

"Two hundred fifty nuyen per," she replied, "and that's up in the nosebleeds. Good seats?" She shrugged. "A thousand nuyen? Two? Nobody knows." She frowned, a pretty little moué. "What about a second show, boss? It'd sell out like *that*." She snapped her fingers. "We'd rake."

He smiled indulgently. *Tangent's a smart girl*, he thought, *but she's got a lot to learn about the biz*. "No second show," he told her. "Always keep the kids wanting more. Think: one show this year. How much more can we charge for next year's show?"

Tangent grinned. "I got it, boss." She shook her head in amazement. "This is big. This is the biggest show we've ever done."

Allenby nodded agreement. *This is the biggest gig Seattle's ever seen. Bigger than Maria Mercurial, bigger than Concrete Dreams. And it's mine.*

The telecom beeped. Tangent jumped up, heading back into the front office to take the call. She stuck her head back around the door. "Boss, what if it's Teague? Take a message?"

"Frag him!" Allenby screamed. "I'd rather die than talk to him!"

White-faced, Tangent ducked back into her office. Allenby's mug shattered against the wall, spraying soykaf all over the door.



# INTRODUCTION

**One Stage Before** is a roleplaying adventure set in the world of Shadowrun.

The year is 2053. Advances in technology are astonishing, with humans able to merge with computers and travel through that electronic netherworld of data known as the Matrix. Even more astonishing is the return of magic. Elves, dragons, dwarfs, orks and trolls have assumed their true forms, while megacorporations (rather than superpowers) rule much of the world. North America has been balkanized, split into several sovereign states, many occupied only by Native Americans. Moving among it all like whispers in the night are the shadowrunners. No one admits their existence, but no one else can do their secret work.

This adventure takes place in the shadows and back alleys of Seattle's urban sprawl. The vast sprawl includes the original city of Seattle and the surrounding sixteen hundred square miles on the eastern shore of Puget Sound. Yet this vast megaplex is but an enclave set amid even larger states ruled by Native American nations and other sovereign states of metahumans and Awakened beings.

## GAMEMASTERING NOTES

**One Stage Before** uses a decision-tree format, meaning that the players' team may arrive at the same encounter via different routes, depending on choices they make, and may easily skip a planned encounter. To run the adventure, the gamemaster needs a thorough familiarity with the contents of this book as well as a working familiarity with the basic **Shadowrun** rules. The contents of this book are for the gamemaster's eyes only, except for certain items earmarked as player handouts. This book includes everything needed to play **One Stage Before**.

**One Stage Before** is designed for a party of four to eight player characters. The group should contain a variety of talent, including at least one mage or shaman, and one decker. A successful run will also depend on the team's combat skills. Players may use any of the character Archetypes listed in the **Shadowrun** rules or in the various supplements to **Shadowrun**, or they may generate their own characters.

This adventure combines several approaches to gamemaster information. Some encounters are thoroughly planned and described in detail. Others merely set the scene, remaining open-ended. Hints for gamemastering the various encounters appear in each section.

## SHADOWRUN RULES

**One Stage Before** may be played using the original **Shadowrun** or **Shadowrun, Second Edition (SRII)** rules. Information, specifically game statistics, appear in standard **Shadowrun** format. Where a value or rule changed from **Shadowrun** to **SRII**, the second-edition value or rule appears in **(boldface brackets)**.

## MAKING SUCCESS TESTS

During the course of **One Stage Before**, the players will make a number of Success Tests using a skill and a given target number. These Success Tests are indicated by the name of the appropriate skill and the target number. For example, a Stealth (4) Test refers to an Unresisted Stealth Success Test with a Target Number of 4.

Under **SRII** rules, the notation Stealth (4) refers to a standard Stealth Success Test with a Target Number of 4. The procedure stays the same; the test has simply been renamed for **SRII**.

## SUCCESS TABLES

At times, the gamemaster will use success tables to determine how much information the players receive. Each success table lists different information for different numbers of die roll successes. Rolling a high number of successes always reveals the information for the lower numbers of successes as well. For example, a character rolling 3 successes would learn the information for 3 successes as well as the information for both 1 and 2 successes.

## HOW TO USE THIS BOOK

Aside from the basic **Shadowrun** rules, this book includes everything needed to run this adventure. **Sprawl Sites**, **The Grimoire**, and the **Street Samurai Catalog** sourcebooks may also be useful. The **SRII** versions of the Contacts and Archetypes referred to within the adventure appear in **SRII**, or in the book included in the **SRII Gamemaster Screen (SRIIGM)**. The gamemaster should read through the entire adventure before beginning the game. Some important plot developments will not unfold until well into the adventure, but the gamemaster will have to lay the groundwork much earlier on. He can only do that by being familiar with the storyline. The gamemaster should also examine the maps, plans, and diagrams found throughout **One Stage Before**, especially the floor plans of the various buildings.

The **Plot Synopsis** summarizes the story background and the most probable course of the adventure.

**One Stage Before** begins with **Meet Mr. Johnson**, which offers suggestions on how to get the ball rolling and draw the player characters into the adventure.

Most of the encounters begin with **Tell It To Them Straight**, a text section to be read aloud to the players. It describes the setting

and action from the characters' point of view. Any important non-player character (NPC) dialogue is also given here. Special instructions to the gamemaster are printed in **boldface** type.

Next comes **Behind the Scenes**, which tells the gamemaster what is going on in each encounter and gives the possible direction of events. Any maps needed to play this encounter are included in this section. Non-player character stats needed to roleplay the section are usually included here as well.

Finally, **Debugging** gives suggestions for getting the game back on track if things go too far wrong. For example, most gamemasters will not want the characters to get too discouraged or be killed off too easily. However, the gamemaster is free to ignore these hints and let the chips fall where they may.

Several sections at the end of the adventure provide essential information needed throughout the course of the adventure. The **Legwork** section contains information the player characters can obtain through their contacts or through the public data nets. **Cast of Shadows** gives vital statistics and background information on important NPCs appearing in the adventure. **Picking Up the Pieces** lists the Karma awards the player characters receive for completing the adventure, plus any major and minor changes in their lives that will occur as a result of their involvement in the adventure. **Player Handouts** provides miscellaneous information of use to the players, and a newsnet printout lets the players know how the success or failure of their shadowrun affected the world (or their small part of it) and also hints at upcoming events.

## PREPARING THE ADVENTURE

It is impossible to create a published adventure that provides the appropriate opposition level for every diverse group of player characters. Some groups are inherently more powerful than others.

The gamemaster must adjust the game statistics and capabilities of the opposition to provide an appropriate level of difficulty for the group. If the adventure does not suit the player characters' strengths and weaknesses, the gamemaster may use it as an outline, the bones to develop an adventure of his own. Or, if it works well except for a quirk here and there, the gamemaster can change any part of the plot and story events to make the adventure a better one for the players.

Each of the NPCs has suggested Threat and Professional Ratings. As indicated in the **SRII** rules, use Threat Rating dice in place of Dice Pools for NPCs (**SRII**, p. 187). Gamemasters should adjust the actual Threat Ratings to better reflect the level of opposition presented by the player characters.

Such manipulation will be crucial to running some of the firefights in this adventure at a manageable level. The fights in **One Stage Before** work best choreographed like an action movie. Though lead and magic flies everywhere, only a few of the bad guys actually get a clean shot at the heroes at any one time. That limitation, and the application of the **SRII** Professional Rating rules, should help keep the large fights under control.

For gamemasters using the first-edition **Shadowrun** rules, the Professional Rating system works as follows. NPCs with a Professional Rating of 1 will withdraw from a fight after taking a Light wound, those Rated at 2 will withdraw after taking a Moderate wound, those Rated at 3 after a Serious wound, and those Rated at 4 will fight until unconscious or dead.

## PLOT SYNOPSIS

*The Shadows? You don't know them? Chummer, you got to be some kind of brain-dead trog not to know that band. The Shadows—they're it. Wiz. They're the megastars to end all megastars. And they're coming to Seattle. Simsense? Sure, you can see them on simsense. I got all their chips, some pirates, too. Make you rave, they're so good. But seeing them live? That's the trip, chummer, the ultimate. They say simsense's as good as being there. Better, 'cause you know you ain't gonna get geeked by the crowd. I don't buy that. Being there, saying you've been there, that's it. Nothin's better.*

—Anonymous Shadows fan

The Seattle metroplex has gone crazy. At the center of a media frenzy that makes the Rolling Stones' publicists look like pikers is a band called The Shadows, scheduled to play a single show at the Kingdome. Sixty-five thousand tickets, at least hundreds of them counterfeit, sold out in one hour; the final body count at ticket offices across the plex reported ten dead, and fourteen missing, believed disappointed. Those lucky enough or rich enough to get tickets live in fear of scalpers, willing to kill for these tickets in order to sell them at vastly inflated prices.

In the midst of this media frenzy, "Mr. Johnson"—actually Jonathon Teague, an executive for Highstar Incorporated, a subsidiary of Mitsuhaman—approaches and hires the runners for a little job, something of minor significance, but requiring some delicacy.

Teague tells the runners that Highstar works with a company called Caravan, and his superiors are concerned about recent death threats against Caravan's president, an irascible dwarf named Allenby. According to Teague, Allenby wants to dismiss the threats as a bad joke, and so refuses to cooperate with any investigation. Teague plans to handle the investigation into the threats without involving Allenby. What makes the situation rather touchy is that Caravan manages the performance and recording career of The Shadows. Teague hopes the runners can look into the threats without letting anyone else find out about it. If the threats against Allenby become public knowledge, Caravan stock might drop, and he might even be forced to cancel The Shadows' concert. Teague points out that neither would be particularly good for business.

Predictably, appearances deceive. Teague actually intends to buy out Caravan. Unfortunately for Teague, Allenby controls a majority of Caravan stock, and he refuses to sell. Teague hopes to use a complex plan he has concocted to eliminate Allenby and frame the runners for the murder using a rogue decker and a booby-trapped simsense chip. After all, what good is the word of known shadowrunners against a corporate executive, particularly when the shadowrunners get themselves a little dead all of a sudden?

On Teague's instructions, the runners visit Allenby, who promptly kicks them out of his office as soon as they mention Teague. Obviously, the dwarf has something against Teague, and now, by association, the runners.

As they leave the Caravan building, the runners meet Wallace ("just Wallace"), an FBI investigator trying to dig up information on Allenby. Though he refuses to admit it to the runners, Wallace is trying to discover the connection between Allenby, the runners, and Teague.

## INTRODUCTION

The runners part company with Wallace. As they jander down the street, beginning to wonder what is really going on, they encounter a Lone Star patrol car cruising the area...and the patrol tries to cut the runners down, for no apparent reason! In fact, a warrant is out for the runners' arrest; they have been charged with murdering Allenby and are described as armed and dangerous. If the runners try to contact Teague to find out what he knows, they find him "in conference."

Unable to contact their employer, the runners conclude they have been abandoned, if not actually set up. Then they receive a message that someone else from Highstar wants to meet with them. The runners meet Meta, one of Teague's employees who disapproves of Teague's machinations and tells them something she thinks they should know: Allenby is dead. Unfortunately, she has no details. While meeting with Meta, the team rebuffs an attack by a mucker gang calling themselves the Teddy Boys, during which Meta demonstrates lethal chrome and fighting skills.

Soon after that attack, Teague invites the runners to another meet. Teague says he has information that he needs to pass on indicating that the same person who offed Allenby wants the runners dead as well. The meet turns out to be a brutal ambush, with corporate enforcers, wage mages, and even other shadowrunner muscle vying to cut down the runners. The survivors get the message loud and clear, this time: Teague set them up. Once again, when the runners try to contact Teague, he is "unavailable." Both his offices and city home are guarded by small armies.

Just as the runners catch their breath, they hear from Tangent, Allenby's secretary. She knows Allenby was still alive when the runners left, so they could not have killed him, and she wants to tell them about Allenby's final hours. He planned to spend the day going through simsense demos sent to him by bands looking for representation. Allenby always downloaded these demos onto his computer system for storage and review as they came in, and when Tangent decided to go through the demos herself, to send form letters back to the applicants, she found the entire directory blown away and all the demo files deleted.

Tangent also describes someone who could only be Wallace who came to see her after Allenby's death, claiming to be a friend of the runners. Wallace asked questions about the runners' relationship with Allenby while trying to pretend he knew them. (Too smart to buy that line, Tangent told him nothing.)

Tangent feels that things are getting too weird at Caravan to safely stick around, but before she goes underground, suggests the runners talk to The Shadows. The band—or the revenue it represents—probably lies at the core of recent events. The secretary tells the runners about a glitzy party happening that evening at a hot media producer's house. The band will be there, along with just about everyone who is anyone. Tangent gives the runners some extra invitations she happens to have lying around.

The runners attend the party, meeting members of a go-gang called the Nightstalkers, who are providing security. The Shadows make the strange toast, "To absent friends, and to those who are no further away than sunset." It means nothing to the runners, but they do not puzzle over it for long, because just as Teague arrives at the party, he spots the runners and takes off again. The runners pursue him, but he escapes in his limo.

Tangent next suggests the runners speak to one of Allenby's



other employees. The team goes to meet this person, arriving just in time to see him and his house blown up by a bomb.

By this time, the team realizes it has a shadow: a member of the Nightstalkers go-gang, the same gang that provided security at the media party. They manage to follow the ganger to his headquarters, and meet with the gang leader, who is Jetblack, a famous musician who faked his own death several years ago and dropped into the shadows. Jetblack has become a vampire.

Jetblack was fond of his one-time manager, Allenby, and wants to find out who killed the dwarf. He gives the runners the password to access a concealed datastore on Allenby's computer system. When they deck in, the runners discover that a booby-trapped simsense chip killed Allenby. They also find records of Allenby's suspicions that Teague and Highstar were plotting to take over Caravan.

Once again, the runners meet Wallace when leaving Caravan's offices. He tells them that the FBI wants to take Teague down, but for various reasons, he cannot be involved. He can give them the necessary codes to safely access Highstar's system and look for evidence.

The team decker jacks into Highstar's net. Defeating the decker who set up Allenby's death, the runners collect more details on Teague's attempted acquisition of Caravan, but no solid proof that Teague killed Allenby, even though they are certain Teague was responsible. Highstar's system also reveals the address of Teague's hideout, his country home.

They need muscle to break into Teague's compound, so the runners return to the Nightstalkers. Initially unwilling to help, Jetblack eventually agrees to help by sending the Nightstalkers to create a diversion. The runners break into Teague's compound, find what they need to prove themselves innocent of Allenby's murder, and leave Teague to the tender mercies of his own corporation.

# MEET MR. JOHNSON

## TELL IT TO THEM STRAIGHT

Where does the money go? Just a few short weeks ago, you were living high on the hog. No worries about credit, enough nuyen for just about any extravagance your fevered imaginations dreamed up; life was great.

And now here you sit, back at your regular table at the good old Blue Flame Tavern, comparing credsticks. *Somebody's* got to have enough left to pay for a round of drinks. Maybe if you combine your funds...

You glance toward the bar, where the Chinaman is rearranging the grime on a beer mug with a gray cloth. Maybe he could stand you a round. After all, you've poured a lot of money into this august establishment over the past few weeks. But the Chinaman won't meet your eye. His information-gathering network would put the FBI and the CIA to shame, and he knows you're tap city.

Then the strangers walk in. Two of them, their impeccably-tailored business suits outlandish in the Blue Flame. They hesitate for a moment in the doorway, cool eyes scanning the tables. Then they start toward you.

All conversation has stopped; all eyes follow the *shalkujin*. You can almost hear the brains adding up the value of the jewelry these corp-types are wearing: heavy gold watches, rings, diamond earstuds... You wait for someone to make a move on them. *Shalkujin* coming to the Flame dressed like that are just plain asking to be rolled.

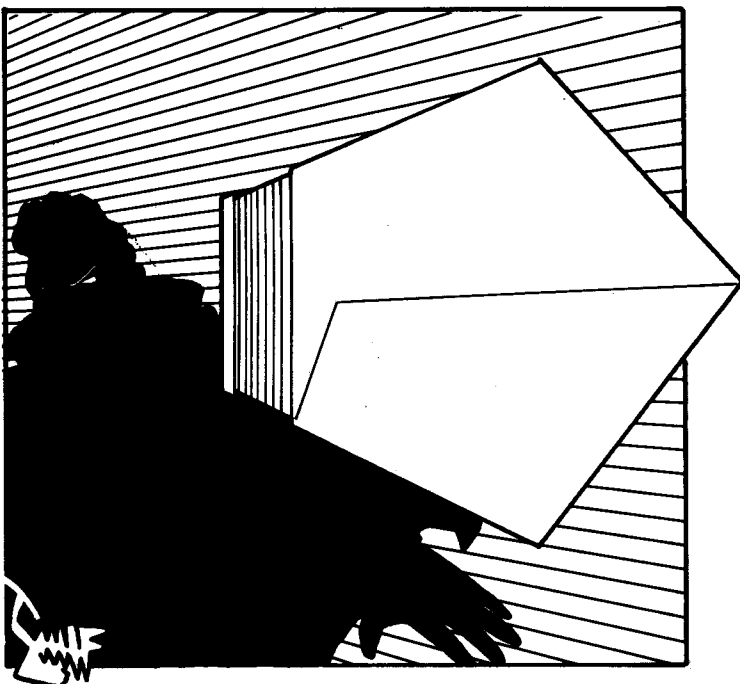

The ork tries it on for size, the one known as "the Pig," 115 kilos of fat, muscle and bad temper, and heeled like a walking armory. You see his bloodshot eyes narrow, and a nasty smile spread across his face.

You're sure the Pig's out of the *shalkujin*'s line-of-sight. But one of them seems to shrug slightly. Silver flashes in his right hand, and is flicked away. With a dull thunk, the hilt of a knife magically sprouts from the wall less than a centimeter above the top of the Pig's oily coiffure, precisely aligned with the centerline of the ork's skull. The Pig's pasty skin goes even whiter as he engrosses himself in reading the graffiti scrawled on the tabletop.

The men stop a couple of paces away from you. Their expressionless faces and relaxed stances are deceiving; their eyes move like radar, missing nothing.

The larger of the two suited figures greets your group by name, individually, his glance attaching the right name to the right body. "You need employment," he says flatly. "Our employer needs your services. If you'll come with us, we'll take you to him." He tosses a credstick on the table. "Here is proof of our employer's good faith. You keep this, regardless of whether you accept his offer or not."

## BEHIND THE SCENES

**Tell It To Them Straight** places the runners in the Blue Flame Tavern, but the gamemaster may use any appropriate locale.

The two corp types are Daniel and Lester, two "junior expeditors" working for Teague and Highstar. Their precise instructions were to bring the runners to meet Teague without causing a fight. To sweeten the setup, Teague sent them with a 5,000 nuyen credstick for the team.

Daniel and Lester do not know what job their boss wants the runners to perform, and so the team cannot extract this information from them. They will not reveal to the runners their boss' name, or what corp he works for. If asked, they reply, "Our employer will make that clear in time." They also keep the meet's location secret. (A simple precaution; if the team knows that, they could set up an ambush. Almost standard operating procedure.) If the team asks Daniel and Lester where they are going, they answer, "Come with us and you'll find out, won't you?"

If the team decides to go with Daniel and Lester and follow them outside, they see a Rolls Royce Phaeton limousine idling at the curb. The chauffeur sits in the driver's compartment, jacked into the control system. Daniel and Lester usher the runners into the spacious passenger area, where Lester joins them. Daniel sits with the driver up front. When everyone is settled, the car heads downtown.

**Gamemaster's Note:** Remember that in the following character descriptions and statistics, and in all following encounters, the statistics in (boldface brackets) and the Threat/Professional Ratings refer to SR11 rules.



# MEET MR. JOHNSON

## DEBUGGING

Unless the runners decide to geek Daniel, Lester and the driver—not necessarily an easy proposition—and take off with the Phaeton (worth 500K nuyen, after all), this should be a straightforward meet and greet. If they take this rash action, Teague mobilizes Highstar's considerable security resources, perhaps bumping the operation up the line to Highstar's owner, Mitsuhama. Unless the runners get out of Dodge *right fraggling now*, their lives will be short and interesting.

If the runners simply turn down Daniel's invitation to go for a little ride, the team receives another invitation to meet with Teague a couple of days later, through a fixer the team trusts. If they accept this invitation, Daniel and Lester again bring the Phaeton to pick them up. Go to **Walk in the Park**, the next scenario.

If the runners turn down the invitation even when it comes from their fixer, Teague picks another team for his job.



### DANIEL

A tall, slender human, Daniel Maynes is always perfectly groomed and exquisitely dressed. He has a reputation for being constantly cool and inhumanly calm, the perfect corporate "expediter."

**B** 6 (7) **Q** 4 **S** 5 **C** 5 **I** 4 **W** 5 **E** 2.5 **M** — **R** 4 (8) **Armor** 4/2

**Initiative:** 4 (8) + 3D6

**Dice Pools:** Defense (Armed) 5, Defense (Unarmed) 3, Dodge 4 (**Threat/Professional Rating:** 5/3)

**Skills:** Armed Combat 5, Etiquette (Corporate) 5, Etiquette (Street) 2, Firearms 5, Negotiation 5, Psychology 3, Stealth 2, Unarmed Combat 3

**Cyberware:** Dermal Plating (1), Wired Reflexes (2)

**Gear:** Browning Ultra-Power (Heavy Pistol, 10 (clip), {SA}, 4M2 {9M}), w/Laser Sight), Lined Coat (4/2), Survival Knife (5L3 {7L})

### LESTER

Slightly shorter and stockier than Daniel, Lester Hatton shares his partner's control and cool. When dealing with people, or with problems able to be solved logically, Lester defers to his partner. But when things get rough, and the hard option is the only option, Lester takes center stage.

**B** 6 **Q** 5 **S** 6 **C** 6 **I** 3 **W** 5 **E** .5 **M** — **R** 4 (10) **Armor** 4/2

**Initiative:** 4 (10) + 4D6

**Dice Pools:** Defense (Armed) 6, Defense (Unarmed) 5, Dodge 8 (**Threat/Professional Rating:** 5/3)

**Skills:** Armed Combat 6, Etiquette (Corporate) 4, Etiquette (Street) 2, Firearms 6, Negotiation 1, Stealth 3, Unarmed Combat 5

**Cyberware:** Dermal Plating (1), Smartgun Link {Smartlink}, Wired Reflexes (3)

**Gear:** Browning Ultra-Power [Heavy Pistol, 10 (clip), {SA} 4M2 {9M}], w/external smartgun adapter {external smartlink}], Lined Coat (4/2), Survival Knife (5L3 {8L}), 2 Throwing Knives (3L1 {6L})

### DRIVER

He wears the same impeccable corporate fashions as his two partners. He does not speak to the runners (his job is to drive, not talk).

**B** 3 **Q** 5 **S** 3 **C** 4 **I** 4 **W** 4 **E** 3.75 **M** — **R** 4 (8) **Armor** 4/2

**Initiative:** 4 (8 when rigging) + 1D6 (3D26 when rigging)

**Dice Pools:** Defense (Armed) 2, Defense (Unarmed) 1, Dodge 5 (**Threat/Professional Rating:** 3/2)

**Skills:** Armed Combat 2, Car 4 (Passenger Vehicles 6, Specialization: RR Phaeton 8), Etiquette (Corporate) 4, Etiquette (Street) 1, Firearms 3, Unarmed Combat 1

**Cyberware:** Radio, Vehicle Control Rig (2)

**Gear:** Beretta Model 200ST [Light Pistol, 26 (clip), {SA/BF}, 3M2 {6L}], capable of burst autofire (max 3 shots)], Lined Coat (4/2)

### ROLLS ROYCE PHAETON

**Handling** 4/4 **Speed** 60/180 **B/A** 5/2 [6] **Sig** 2 **APilot** 4

**Seating:** Twin + 6 bucket seats + 3 folding

**Access:** 2 + 4 standard

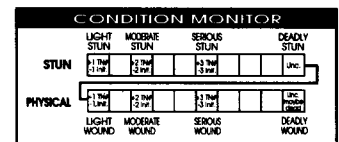
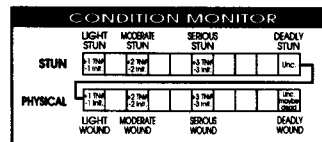

### DANIEL

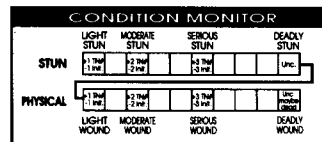

### LESTER

### Driver

### Rolls Royce Phaeton

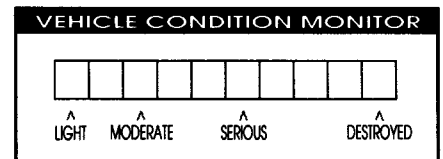

# WALK IN THE PARK

## TELL IT TO THEM STRAIGHT

The Rolls cruises silently into the downtown core of the sprawl. You guess your destination well before the limousine pulls to a smooth stop. Kobe Terrace Park, at South Jackson Street, just west of the freeway. A beautiful spot, a little oasis of green surrounded by corporate skyscrapers.

And usually a deadly spot. Despite the best efforts of Lone Star and corporate security forces, Kobe Park frequently serves as a killing ground at night, a battlefield for downtown gangs.

At this time of day, however, the place appears deserted. As your business-suited minders usher you out of the car, there's no one in sight.

Another business-suited human seems to materialize from behind a tree. Though superficially the same as Daniel and Lester, this man is different, and you recognize that immediately. His air of command tells you that this is your potential employer. Your escort drops back as you approach, careful to keep you and their boss in sight, but well-enough trained to give you some privacy.

The high-powered corp speaks, his voice smooth and well-modulated. "Thank you for accepting my invitation. My name is Jonathon Teague. I need your services, and I think you will find it worth your while to accept my offer.

"No doubt you've heard of the band The Shadows?" he asks, barely pausing before he continues. "I thought so. Who hasn't? They're the biggest recording act and live draw in the music business today. Do you have tickets to their upcoming Seattle show? No? Well, perhaps I can secure a few for you should we come to an agreement today."

The suit pauses, apparently to order his thoughts. "As you may or may not know," he goes on, "The Shadows are managed by a company called Caravan Productions—specifically, by a gentleman by the name of Allenby. The company I represent, Highstar Incorporated, deals with Allenby. Our business with Caravan is not directly related to The Shadows, though the cash flow derived from the band has some bearing on our discussions.

"Over the last several weeks Allenby has been the focus of several disturbing occurrences. On several occasions he received death threats, and three days ago his car blew up. Fortunately, whoever set the explosive charge made it too small to do much damage, and Allenby walked away unhurt.

"It would obviously be in everyone's best interest, ours and Allenby's, to discover who is behind this and, um, *terminate* the flow of events, as it were. However, Allenby wants to handle the matter alone. My principals find that unacceptable. If Allenby is killed—or if the threats against him become public knowledge—

Caravan shares will drop in value, and the company may be forced to cancel The Shadows' concert. Neither of these eventualities would be good for business.

"That's why I've contacted you," the suit goes on smoothly. "My principals want you to investigate the attempts on Allenby's life, to find the responsible party, and turn them over to us for, um, *processing*. In return, I am authorized to pay you a total sum of 80,000 nuyen—10,000 now as a binder, and the remainder on completion of the assignment.

"I suggest that you start your investigation by speaking with Allenby. Though he won't be pleased, we want him to know that you are seeking out his would-be killers on our behalf."

Jonathon Teague regards you coolly. "Any questions?"

## BEHIND THE SCENES

Information on Teague appears in *Cast of Shadows*, p. 54. He hands the runners a certified credstick for 10,000 nuyen and the address of Caravan's offices: Suite 500, 2265 Occidental Avenue, down near the docks south of the Kingdome. If the runners ask, he can also supply Caravan's LTG number: 1206 (53-2817).

Teague refuses to reveal any information about his position with Highstar, and if questioned answers with a vague description: "Junior expediter, you might say. I make things happen." He also declines to answer any questions about Highstar's business dealings with Caravan by saying the runners do not need to know that information to do their job.

If the runners try to negotiate for an even healthier payment, Teague willingly ups the "on-completion" payment, agreeing to anything up to a 50 percent increase. (He can afford to be agreeable: as will become apparent later, he has no intention of paying any amount.) He will not increase the binder payment, however, as he only has 10,000 nuyen on him.

The first step is to contact Allenby. Go to **Face to Face**, the next scenario.

## DEBUGGING

Unless the runners do something really stupid, like try to take Teague hostage or roll him, this should be an uncomplicated meet. If the runners make a false move, Daniel and Lester, plus seven other similar security personnel (use Daniel's stats for three of them, and Lester's for the other four) emerge from the bushes and do their best to nail the runners...without killing Teague, of course.

If the team appears uninterested in his offer, Teague raises the "on-completion" payment so high that only idiots would walk away.



# FACE TO FACE

## TELL IT TO THEM STRAIGHT

Caravan's address leads you to an old building, probably dating from before the turn of the century and constructed of gray ferroconcrete, rather than the currently popular heavy construction plastic and ceramic composites. Decades of Seattle's "hard rain" has pitted the concrete and discolored it with black streaks. Counting rows of windows as you approach, you realize that Suite 500 must be on the top floor. Entering the lobby, you check the directory mounted on the wall next to the elevators. "Caravan—Floor 5."

You look around. This building *is* old, and kind of odd: no security cameras in sight, not even a bulletproof macroplast security booth. And no security guards. Corp wannabes are the only sign of life in the lobby, and most of them stare at you so hard that they practically trip over their own feet. No threat to you. You jander into the elevator and ride to the fifth floor.

The elevator opens on a narrow hall. The sign on the wall indicates Suite 500 is to your right. You follow the hallway, and sure enough, the door facing you reads "Caravan Productions Corporation." You push it open and step into a reception room that is surprisingly well-appointed, considering the shape the building's in. Platinum disks—the kind awarded for best-selling music albums and chips—dot the walls, most of them belonging to The Shadows. A couple name some old novastar named Jetblack. (*Jetblack?* It takes you a minute, but you finally remember his name. Jetblack was one of the innovators of a genre known as angst-rock—really dark, soul-hurting music. Jetblack was one of the hottest. But you heard he died a while back. So Caravan managed him too, hmm?)

The room's furnishings hold your attention for only a moment, then your eyes flick to the receptionist, a beautiful young woman with a mane of golden hair. A man about the same age stands next to her, wearing inexpensive copies of high corp fashion. You see the metallic glitter of a datajack in his forehead. When you walk into the room he looks you up and down, and backs away from the reception desk.

Impossibly blue eyes look at you, a little nervously. "Uh...yes?" the receptionist says. "Can I help you?"

**If the team barges through into Allenby's office, read the following:**

The inner office is larger than the reception area, and even better decorated. More platinum disks and other awards shine on the walls, highlighted by track lighting mounted on the ceiling. A huge desk—heavy, dark wood, probably an antique—takes up the middle of the room. A sophisticated computer system sits on top of it, connected by a slender fiber optic line to the datajack in the head of a balding, ugly dwarf with thick black hair and an unruly black beard: obviously Allenby. Flint-hard eyes glare at you out of a wrinkled, leathery face. The dwarf's lips draw back from his teeth in a snarl.

"And just who the frag are you?" the dwarf growls.

## BEHIND THE SCENES

The receptionist is, of course, Tangent. The young man with her is David Graves, one of Caravan's database clerks.

At the moment, Tangent's instructions are to tell anyone asking to see Allenby that he is in conference. She will take messages, but will not put calls through to her boss. If the runners demand to see him or otherwise press Tangent, she nervously changes her story, saying "Look, he's out," and glances over her shoulder at a door behind her and to the right. The nameplate on that door reads "Allenby."

Tangent will not try to physically block the runners from walking past her and opening that door. If they do, she follows them, apologizing profusely to Allenby—who, of course, is in his office—for not stopping them.

The dwarf behind the desk in the inner office is Allenby. He is in a worse mood than usual, and the runners' sudden appearance makes his day even worse.

Allenby demands to know who the runners are and orders them out of his office without waiting for an answer. If the runners stick around and face down the dwarf, he uses his only weapon, his soykaf mug, against the runner who annoys him most.

If questioned about the death threats, Allenby dismisses the issue, saying, "When you're as successful as I am, you've always got enemies." If the runners continue to question him on the subject, he admits that the number of threats has increased recently, but he plans to ignore them, as usual. He discounts the sabotage against his car as a practical joke, claiming the explosion was nothing but a "fragging smoke charge."

In this encounter, Allenby is arrogant and offensive, constantly telling the player characters that he does not "work with street punks," and tossing out plenty of insults.

Allenby reacts most violently to any mention by the runners of Teague or Highstar. Either name simply makes Allenby even angrier, impossible though that may seem. "Those vultures?" he rages. "Get out! Frag it, get out! Go tell them to suck dried lizard drek." Allenby will not listen to any explanation the runners try to give, and refuses to discuss the matter at all.

If the team does not leave immediately when he shouts at them to get out, Allenby hits a key on his computer. Several seconds later, his personal bodyguard, a troll named Gnasher, arrives to "escort" them out of the building. Unless the runners agree to leave quietly, Allenby may die of apoplexy anyway, and they will have failed in at least part of their mission. If the runners ask Tangent on their way out why Highstar and Teague upsets Allenby so much, she tells them she has no idea. Her boss's erratic behavior puzzles her as much as it does the team.

When the runners leave the Caravan offices, go to the following section, **The Fed**.



## DEBUGGING

If the runners decide to work through channels and phone Caravan to make an appointment with Allenby, rather than just showing up, they speak with Tangent. She knows how to handle persistent callers, and will not connect the team with Allenby: the "no calls" directive includes everybody, because Allenby is too busy at the moment to waste time on the phone. If the team tries to set up an appointment, Tangent is happy to do so, telling them that Allenby is unavailable for appointments in the near future, but his schedule should clear up a little in two weeks or so (after The Shadows' show at the Kingdome). The team will soon realize that they can only get to Allenby by showing up at Caravan's office.

If Allenby summons Gnasher, his appearance is the runners' cue to leave, not a target for the team to shoot up. In his present mood, Allenby will reveal nothing useful, and so the runners should explore other avenues—perhaps doing some legwork to find out why the dwarf hates Teague and Highstar so much. The gamemaster is free to prompt the team in this direction, if he or she wants. However, at the first sound of gunfire, Tangent and everyone else in the building pushes every PANICBUTTON in sight, and Lone Star speeds to the scene to scoop up the "psychopathic murderers" who offed the troll. Let the team scrap it out with the Star if they choose this option, and let the chips fall where they may. The runners hosed up big time by starting trouble.

## TANGENT

A young, beautiful, and ambitious lady, Tangent has served as Allenby's assistant for several years. She believes that the crusty old curmudgeon has a heart of gold, and works to make sure nothing she does might harm him. Though Tangent sometimes comes across as an airhead, she is intelligent and a good judge of character.

B	Q	S	C	I	W	E	M	R	Armor
3	4	3	6	5	4	4.7	—	4	—

**Initiative:** 4 + 1D6

**Dice Pools:** Defense (Armed) 1, Defense (Unarmed) 1, Dodge 4  
**(Threat/Professional Rating: 0/2)**

**Skills:** Computer 4, Etiquette (Corporate) 3, Etiquette (Street) 3, Music Business 4

**Cyberware:** Datajack with 100 Mp memory, Display Link

**Gear:** None

## DAVID GRAVES

A shy young man, Graves works for Allenby as database clerk. A musician wannabe, he figures working in the business is one way to break in as a performer. Monsters like the runners scare him. (Most things scare him, to be honest.)

B	Q	S	C	I	W	E	M	R	Armor
3	3	2	3	3	2	2.7	—	3	—

**Initiative:** 3 + 1D6

**Dice Pools:** Defense (Armed) 1, Defense (Unarmed) 1, Dodge 3  
**(Threat/Professional Ratings: 0/1)**

**Skills:** Computer 4, Etiquette (Corporate) 3, Etiquette (Street) 1, Music Business 2

**Cyberware:** Datajack with 300 Mp memory, Display Link

**Gear:** None

## GNASHER

Gnasher is better-spoken than most troll bodyguards the runners have met, and calmly asks the team to leave quietly. If push comes to shove, he shoves as hard as necessary to make them depart.

B	Q	S	C	I	W	E	M	R	Armor
11	5 (7)	9 (11)	3	3	4	1	—	4 (8)	4/2

**Initiative:** 4 (8) + 3D6

**Dice Pools:** Defense (Armed) 4, Defense (Unarmed) 4, Dodge 7  
**(Threat/Professional Rating: 5/3)**

**Skills:** Armed Combat 4, Etiquette (Street) 3, Firearms 5, Unarmed Combat 4

**Cyberware:** Muscle Replacement (2), Wired Reflexes (2)

**Gear:** Lined Coat (4/2), Manhunter [Heavy Pistol, 16 (clip) (SA), 4M2 (9M), w/Laser Sight], Survival Knife (11L3 {13L})

		LIGHT STUN				MODERATE STUN				SERIOUS STUN				DEADLY STUN			
STUN	1-10	11-20	21-30	31-40	1-10	11-20	21-30	31-40	1-10	11-20	21-30	31-40	1-10	11-20	21-30	31-40	
	PHYSICAL																
PHYSICAL	1-10	11-20	21-30	31-40	1-10	11-20	21-30	31-40	1-10	11-20	21-30	31-40	1-10	11-20	21-30	31-40	
	LIGHT WOUND MODERATE WOUND SERIOUS WOUND DEADLY WOUND																

## TANGENT

		LIGHT STUN				MODERATE STUN				SERIOUS STUN				DEADLY STUN			
STUN	1-10	11-20	21-30	31-40	1-10	11-20	21-30	31-40	1-10	11-20	21-30	31-40	1-10	11-20	21-30	31-40	
	PHYSICAL																
PHYSICAL	1-10	11-20	21-30	31-40	1-10	11-20	21-30	31-40	1-10	11-20	21-30	31-40	1-10	11-20	21-30	31-40	
	LIGHT WOUND MODERATE WOUND SERIOUS WOUND DEADLY WOUND																

## GNASHER

		LIGHT STUN				MODERATE STUN				SERIOUS STUN				DEADLY STUN			
STUN	1-10	11-20	21-30	31-40	1-10	11-20	21-30	31-40	1-10	11-20	21-30	31-40	1-10	11-20	21-30	31-40	
	PHYSICAL																
PHYSICAL	1-10	11-20	21-30	31-40	1-10	11-20	21-30	31-40	1-10	11-20	21-30	31-40	1-10	11-20	21-30	31-40	
	LIGHT WOUND MODERATE WOUND SERIOUS WOUND DEADLY WOUND																

## DAVID GRAVES

# THE FED

## TELL IT TO THEM STRAIGHT

You walk back out of the building housing Caravan's offices, still a little confused as to what exactly happened in there. A figure detaches itself from the gray-black wall near the corner of the building. A big figure, definitely human, but bulky enough to pass for troll whenever it suits his fancy. He wears a black duster and dark street clothes. As he approaches you, he holds his empty hands out from his sides, showing that he's unarmed—or, at least, that he has no weapon ready to use at the moment. He has a wry half-smile on his face, as if he can read your caution directly from your minds.

"Hoi, chummers," he says affably. "Got a minute to shoot the drek? I'm looking for work, and I think you might be able to help me out."

## BEHIND THE SCENES

The big fellow introduces himself as Wallace—"just Wallace." For more information, see **Cast of Shadows**, p. 56. On a successful Perception/Intelligence (3) Test, the runners notice that Wallace carries enough chrome to remodel a modern kitchen, and moves like a jungle cat. Their first impression targets him as street samurai, maybe ex-army. If the runners mention their impression, Wallace admits to serving several Desert Wars tours with the UCAS Marines. But now he is back to civilian status and looking for employment.

Not the kind the runners might expect: he says he has no desire to run the shadows. Wallace claims that before he joined the army, he spent time in the entertainment biz, and wants to get back into his old trade. He knows enough about the industry to satisfy any of the team's questions. He is considering approaching Allenby for a job, he says, but wants a little background information for the inside track. Wallace pumps the runners for information on Allenby's current business status, and wants to know if Allenby might be in the market for an "expediter" and assistant. Wallace slips a few questions into his admittedly plausible spiel to try to discover what connection the runners might have with Allenby and Caravan.

As often happens in this biz, Wallace is less than completely honest with the runners, but no matter how hard the team presses him, Wallace sticks to his story. He is willing to walk away and forget about the whole thing. If the runners push too hard, he shrugs, and remarks, "Well, if you won't help me out, I can't make you. See you around, chummers."

Both players and characters may find this encounter odd, if not downright weird. So be it. Paranoia is the Shadowrunner's way of life. Let them wonder just who the frag that guy was.

Go on to **Armed and Dangerous**.

## DEBUGGING

Wallace is too good for the runners to mess with and win, but he is not looking for a fight, and will not initiate hostilities. At the moment, he prefers talking to fighting, standing by his cover story no matter what. If the team tries to detain him or rough him up, he fights to save his own life and escape. Whatever happens, he continually tries to convince the runners to let him go in one piece.

A particularly militant team might decide to take Wallace down, but will find nothing on him that does not fit his cover story. If Wallace dies here, when he reappears in **Wallace Again**, p. 35, substitute another Federal agent to make the contact, using Wallace's stats and background. (The FBI has access to a good number of Wallace "clones.") Now when Lone Star comes after the runners in **Armed and Dangerous**, they want the team for Wallace's murder as well as Allenby's. Even if the runners duck the murder rap for Allenby by the end of the adventure, icing Wallace puts them in deep drek.



# ARMED AND DANGEROUS

## TELL IT TO THEM STRAIGHT

**Gamemaster's Note:** This encounter should occur at least three hours after the team meets with Allenby, but before they dig up much information. Lone Star strikes at the team or individual runners on the streets.

The streets of Seattle are slick with oil floated out of the road surface by the heavy rain. The clouds overhead form an unbroken lead-gray ceiling, and the hard rain pours down in sheets, lashed by a vicious west wind. You look enviously at the people driving by in their cars, warm and dry while you're wet and cold. Ah, well, the world's never been fair, has it? A Lone Star patrol car—a Chrysler-Nissan Patrol-One, the most common patrol vehicle in this part of town—cruises slowly past. Four helmeted officers stay dry inside.

Suddenly, a light stabs through the curtains of rain. The car's spotlight washes over you and your fellow runners, and the car screeches to a halt, the back end swinging toward you with the force. The doors burst open and officers swarm out like angry yellow jackets. One screams, "Turn to Ice, you fraggers!" The first gunfire reports and muzzle flashes are simultaneous with the yell.

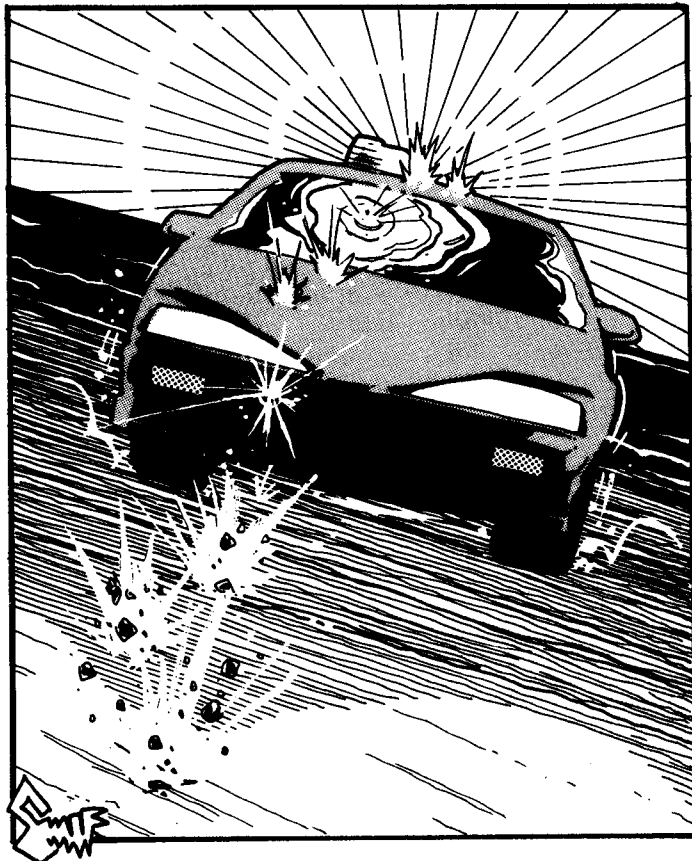

## BEHIND THE SCENES

By this time, Allenby is dead. Lone Star received an anonymous tip shortly after the runners left the Caravan offices that, backed by evidence (manufactured, but still apparently irrefutable), points to the runners as the guilty party. All patrol cars in the area received an all points bulletin stating that the runners are armed and dangerous and to waive the Rules of Apprehension. In other words, bring in the perps dead or alive...and dead is so much easier. Three of the officers in this car attempt to cut the runners down, using their car as cover, while the fourth calls in for back-up. Placing the call takes three Combat Turns, after which the fourth cop joins the battle. One Lone Star officer is a combat mage.

Depending on how alert they are, the team may have several seconds to act before the lead starts to fly. Have each member of the team make a Perception/Intelligence (4) Test before the fun begins. (If using **SRII** rules, team members make a Surprise Test according to the **Surprise** rules, p. 86. The Lone Star cops add a -1 modifier to their target numbers when taking action. As the runners spotted them, and they are scrambling to get out of a car, their attack is not considered an ambush (no -2 modifier)).

Successes	Result
1 or less	The Lone Star attack is completely unexpected. Only when the first high-velocity rounds start spraying the area do you realize something is going down. (Characters with 1 success or less are surprised.)
2-3	You watch the doors open, and the first thing you see are the weapons. What the frag is going on? (Characters with 2-3 successes are not surprised, and enter the Combat Turn using standard Initiative.)
4+	You can see the expressions on the Lone Star officers' faces and you know that expression means trouble. (Characters with 4+ successes have one Combat Turn in which to take action before the shooting starts.)

The first back-up vehicle, a General Products COP, arrives on the scene 15 Combat Turns after hostilities start. This car contains two more Lone Star troopers, but no combat mage. After 30 Combat Turns, if the fight lasts that long, a third car arrives (another Patrol-One) carrying four troopers (again, no mage). A SWAT team in a Citymaster arrives on the scene five minutes after the second car. Should the runners still be caught in a pitched or running battle

with the cops at this point, feel free to equip the SWAT team with whatever heavy ordnance seems appropriate, and hose the team down. Smart runners will have bugged out by this time, either with or without taking care of the cops.

Go to the next section, **Going to The Mattresses.**

## DEBUGGING

If the runners risk getting their heads handed to them by staying in the fight, suggest that they cut and run in order to fight another day. If the team escapes into the back alleys or the sewers, the cops wait for the SWAT team to arrive before making a move to follow, by which time the runners should be long gone. If the runners are pinned down, or lack the sense to give up a bad position, the gamemaster may introduce another group into the equation, perhaps a militant thrill-gang out for a cruise. Gangers hate Lone Star on principle, and usually join in a fight against the cops for the frag of it. Smart or lucky runners deal with the first group, then cut and run before reinforcements arrive.

If the team snatches a live cop for interrogation, they learn that Lone Star holds warrants to apprehend or terminate the runners for the murder of Allenby. The person who called in the tip gave no details, and the beat cop knows only that Allenby is dead.

The team probably wants to get in touch with Teague at Highstar by this time, but their employer is in conference whenever they phone. And with the entire Lone Star force out looking for them, the runners may not want to drop in at the Highstar building for a chat. If they do try barging in, equip the building with high-tech weapons detectors and chem-sniffers and pack the lobby with security personnel. The team gets no further than the lobby, and cannot find out where Teague lives to visit him at home.

## LONE STAR TROOPERS

Standard beat cops, these troops refuse to risk their lives for a collar. They hunker down behind their vehicles and blaze away until return fire ceases.

**B** **Q** **S** **C** **I** **W** **E** **M** **R** **Armor**  
4 4 4 2 3 3 6 — 3 5/3

**Initiative:** 3 + 1D6

**Dice Pools:** Defense (Armed) 2, Defense (Unarmed) 3, Dodge 4  
**(Threat/Professional Rating: 3/2)**

**Skills:** Armed Combat 2, Etiquette (Corporate) 2, Etiquette (Street) 4, Firearms 3, Police Procedures 4, Unarmed Combat 3

**Gear:** Armor Jacket (5/3), Beretta Model 70 [SMG, 35 (clip) (BF/FA), 4M3 (6M), w/laser sight and silencer], Microtransceiver. In addition, one cop has a CMDT Combat Gun [Shotgun, 8 (clip) (SA/BF), 5M3 (10S)].

## LONE STAR COMBAT MAGE

The combat mage uses his firepower to best advantage by staying well back and firing from a distance.

**B** **Q** **S** **C** **I** **W** **E** **M** **R** **Armor**  
4 4 3 2 4 5 6 4 4 5/3

**Initiative:** 4 + 1D6

**Dice Pools:** Defense (Armed) 2, Defense (Unarmed) 2, Dodge 4, Magic 4

**(Threat/Professional Rating: 4/3)**

**Skills:** Armed Combat 2, Etiquette (Corporate) 2, Etiquette (Street) 4, Firearms 2, Police Procedures 4, Sorcery 4, Unarmed Combat 2

**Gear:** Armor Jacket (5/3), Beretta Model 70 [SMG, 35 (clip) (BF/FA), 4M3 (6M), w/laser sight and silencer], Microtransceiver.

**Spells:** Combat Sense 3, Manaball 4, Powerball 3

## CHRYSLER-NISSAN PATROL-ONE

**Handling** **Speed** **B/A** **Sig** **APilot**  
4/8 60/180 3/2 (6) 4 3

**Seating:** Twin bucket seats + 3 bench

**Access:** 2 + 2 standard

**Notes:** No hard- or firmpoints. Front compartment has one firing port sealed against gas installed in each side window. Each port accepts standard service pistols, submachine guns, shotguns, and rifles, providing a 135-degree firing arc.

## GENERAL PRODUCTS CITY OPERATIONS PATROLLER (COP)

**Handling** **Speed** **B/A** **Sig** **APilot**  
4/9 30/90 1/1 (3) 4 1

**Seating:** 1 + 1 Single bucket seats

**Access:** 1 Canopy

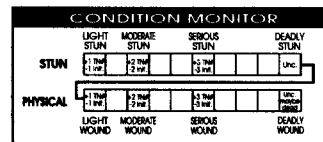

**Lone Star Trooper 1**

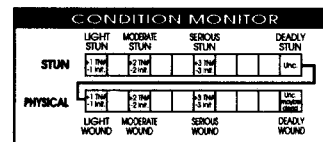

**Lone Star Trooper 2**

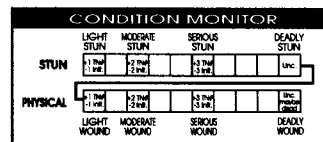

**Lone Star Trooper 3**

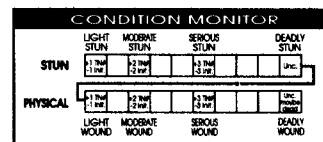

**Lone Star Trooper 4**

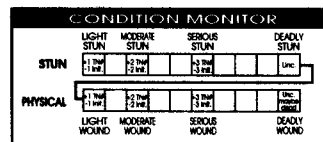

**Lone Star Trooper 5**

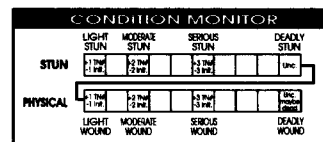

**Lone Star Trooper 6**

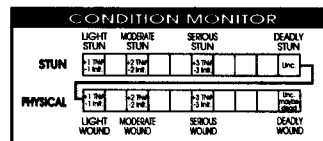

**Lone Star Trooper 7**

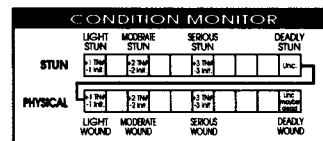

**Lone Star Combat Mage**

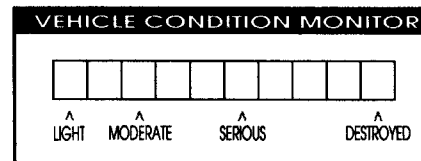

**Chrysler-Nissan Patrol-One**

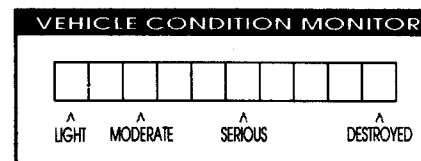

**General Products City Operation Patroller (COP)**

# GOING TO THE MATTRESSES

## TELL IT TO THEM STRAIGHT

**This encounter takes place anytime after the team's run-in with the Lone Star patrol. If the runners lack access to a phone or refuse to answer calls, send the invitation to the meet through another channel, such as a trusted fixer.**

Your telecom beeps, making you jump. You answer the call, feeling fairly anxious.

"My name is Meta," the caller says, with no preamble. It's a woman's voice, strong and assured, but there's no visual. "I work for Highstar as does your current employer. There are some things you should know about your current project.

"I suggest a meet," the woman continues, giving you no chance to reply. "I know a good place. It's a club called The Mattresses, near Seattle Center on Denny Way, by Tam's Under the Needle.

"Bigwigs from all the corps use The Mattresses to meet. It's a guaranteed safe house because club members hunt down and kill anyone causing trouble. Too many people need The Mattresses, and anyone who compromises its safety dies. Do you understand?"

Again the woman gives you no time to answer. "Good. Meet me there in one hour. I'll tell the doorman to expect you; just say you're with Highstar. Dress appropriately." She breaks the connection, leaving you staring at the blank screen.

**If the team goes to The Mattresses, read the following:**

The Mattresses. A strange name for a strange place—right under the Space Needle, which towers above you like an impressionistic spear of light.

Your caller didn't tell you that The Mattresses is an underground club, in more ways than one. A narrow concrete stairway between this building and Tam's leads below street level to a solid metal door. A plaque not much bigger than your hand reads, "The Mattresses—Members and Guests Only."

As you approach the door, it swings open, revealing a small anteroom decorated in dark wood, with rich burgundy carpeting on the floor. A dinner-jacketed elf stands behind a small podium. The *maitre d'*, you assume. He looks you over coolly as you walk in; street types like you fit into this place like pork chops at a synagogue brunch.

Nonetheless, he addresses you politely enough. "Good day. You are guests? Who is your sponsoring corporation, please?"

**If the team gets past the *maitre d'*, read the following:**

The Mattresses' interior epitomizes understated opulence: dark wood, leather-topped tables, leather wingbacked chairs, and art worth several million nuyen on the walls. The place is busy. Two dozen or so customers sit at the tables, all affluent corp types who give you a quick, surprised once-over before returning their attention to the business at hand.

The *maitre d'* appears at your shoulder. "Your party awaits you at the booth by the kitchen," he murmurs, then vanishes.

The woman in the booth he pointed to watches you as you jander over. Tall and well-groomed, she wears the height of corp *haute couture*, save for her mirrored wraparound sunglasses and skintight silver gloves.

"I'm Meta," she says. "I'm here to help you.

"I work as Mr. Teague's expediter," she continues smoothly. "I recently found out through channels that you're assisting him on an important project." She smiles wryly. "You've already failed. Allenby of Caravan is dead."

She shakes her head to cut off your questions. "I don't know the details. I only know he is dead, and there was no sign of violence. His secretary, Tangent, found him sitting at his desk, still jacked into his computer, dead as a slab of meat.

"Though I haven't spoken to Mr. Teague today, I'm assuming he's working on damage control. Allenby's death could hurt Highstar considerably. Likely he'll want you to find out who offed the dwarf. I'm authorized to continue using your services on my own initiative, and I want you to find Allenby's killers and bring them to me."





**When Meta starts to wrap up her conversation with the runners, read the following:**

Sudden gunfire shatters the club's quiet atmosphere. The foyer door bursts open, and orks, dressed in satin and lace and looking like refugees from a historical simsense, fill one end of the room.

"Hose 'em down," the leader yells. The room echoes with gunfire and screams.

**If Meta and the runners take care of the Teddy Boys without help, read the following:**

The sudden silence sounds louder than the gunfire. Except for you, your chummers, and the ruby spots of sighting lasers, nothing moves.

Meta turns to you. "I've got to get out of here. Cover for me, let anyone who cares think you took out the gangers." Before you can ask why, she answers you: "Isn't it obvious? If anybody learns about my edge, I won't be much use to my boss...or to you." She replaces her mirrored shades. "Tell Teague I said to call him. I'll be in touch." Then she sprints for the back door.

## BEHIND THE SCENES

Cautious runners will check out The Mattresses with a contact or two before going to the meet. The Mattresses enjoys a solid reputation on the street. If the runners go to any of their street contacts, make an Etiquette (Street) (3) Test. One success confirms Meta's statement that the club is safe from corporate shootouts. When speaking to a corporate contact, make an Etiquette (Corporate) (2) Test, and a single success produces the same information.

Belying his mild facade, the *maitre d'* at The Mattresses handles all security problems without breaking a sweat. His podium

contains a Rating 8 weapon detector suite. The gamemaster makes an 8-dice Perception Test against the Concealability of any weapon the players carry to determine whether the sensors pick it up. If the scanners detect the weapon, the *maitre d'* names the weapon and its location and asks the runner to check it before entering the club. Club rules allow members and guests to carry only personal-defense weapons. The elf allows the runners one medium or light pistol each and one knife, but nothing else. Characters who refuse to surrender other weapons must stay in the foyer when the rest of the team enters the club.

Any aggressive action on the part of the runners in the foyer accomplishes nothing. Arguing with the elf earns the runners a warning, then personal attention from The Mattresses' security team. Club security normally consists of the following (use the Archetypes listed): five Corporate Security Guards (equipped with Partial Heavy Armor, Stun Batons, Tasers, and Uzi IIs, **SR**, p. 165, **{SRII}**, p. 205), one Company Man (**SR**, p. 164, **{SRII}**, p. 204), and two Wage Mages (**SR**, p. 38, **{SRII}**, p. 56). Appearing in the foyer from various directions within one minute of the first sign of any disturbance, the security team attempts to neutralize and expel, rather than kill, their opponents.

To get past the *maitre d'* without a confrontation, the runners must surrender all obvious weapons, apart from personal gear, and state that they are guests of Highstar.

For the layout of The Mattresses, use the Mid-size Restaurant Archetype from **Sprawl Sites**, p. 37. Each table has a Rating 7 white-noise generator, and a Rating 6 magical ward protects the entire room.

If the runners ask Meta why Teague has failed to either return their calls or contact them in some other way, she tells them he has been too busy to talk to anyone recently.

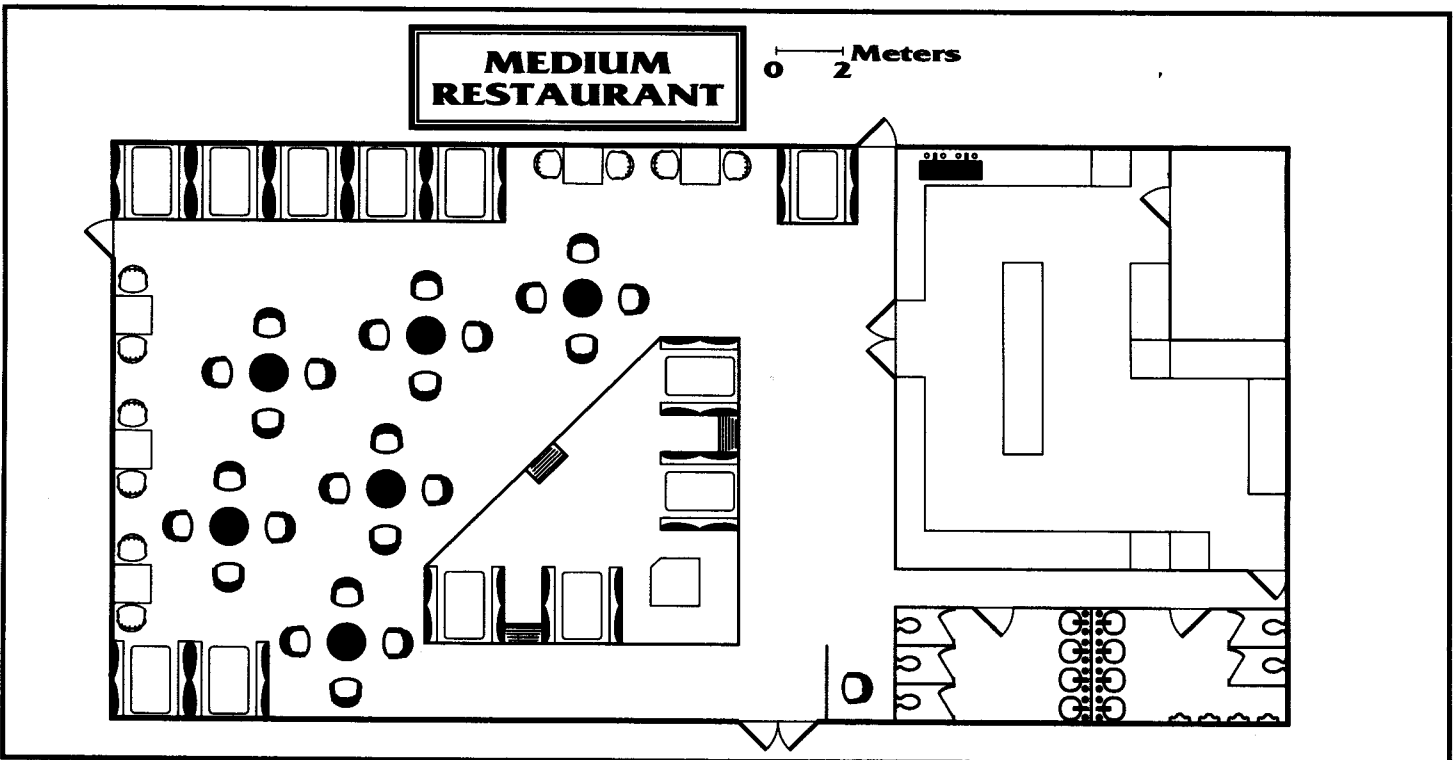



The team (being naturally suspicious) will probably ask Meta why she asked to meet with them, and she gives them the honest answer: she takes pride in her corp status, and wants to help her boss. Personally, she wants to find out who geeked Allenby because that information might be useful. The runners may suspect that she knows why Lone Star wants them, but she truthfully claims ignorance. She promises to look into it, though, and to try to clear up any false accusations linking the team with the murder.

Because Meta is telling the truth as far as she knows it, an analyze truth spell confirms her statements. Teague did not tell her he hired the runners, Meta learned this through her own channels, and so she has no inkling of her boss' darker schemes.

### RANDOM VIOLENCE

The Teddy Boys are a particularly unpleasant "mucker" gang, a mob of vandals who prefer defacing *people* to inanimate objects. Twenty-four gangers overpowered the elf *maitre d'* and the security team to gain entrance to the club, but took serious casualties in the process. Only twelve Teddy Boys remained healthy enough to party.

Give the team a chance to hear and react to the gunfire from the lobby. Have each team member make a Perception/Intelligence (5) Test before the gangers come through the door. (If using *SRII* rules, see *Surprise*, p. 86. The Teddy Boys add a -2 modifier to their target numbers for the advantage of the ambush unless at least one player character achieves 2 or more successes in a Perception (3) Test.)

Successes	Result
0-1	What the frag...? A horde of orks in satin and velvet bursts into the club and starts hosing the place down with autofire, screaming, "Die, you scumsucking motherfraggers!" (Characters with 0-1 successes are surprised.)
2-3	Gunfire in the foyer. A mob of orks in party clothes charge in and open fire. (Characters with 2-3 successes are not surprised. They enter the Combat Turn through normal Initiative.)
4+	Definitely gunfire. Small weapons-drum autofire; sounds like Uzls. The foyer door bursts open, revealing a milling group of orks. (Characters with 4+ successes have one Combat Turn in which to take action before the shooting starts.)

When the Teddy Boys enter the club, Meta's HK227 appears in her hand, spitting death at the attackers. In the first flurry of action, her mirror shades fly off, revealing Zeiss eyes.

While Meta works on cutting down the Teddy Boys, the rest of the patrons dive for cover. The chairs provide Barrier Rating 1 cover, the heavy wood tables provide cover at Barrier Rating 2.

To keep this fight under control, a Moderate wound knocks any Teddy Boy out of the fight (see *Semi-Trained NPC*, *SRII*, p. 187), and so most of the Teddy Boys survive the fight. Once two-thirds of the gang falls, the rest retreat.

# GOING TO THE MATTRESSES



Though the runners find it hard to believe, the Teddy Boys' random attack is actually random. It has no connection with Allenby, Teague, or the shadowrun. If the team manages to question a Teddy Boy, he is able to convince them that the gang always acts like this. The gang attack becomes a *big red herring*, however, if the runners fail to turn up any information from the gang itself. The gamemaster should play the situation by ear. See **Debugging**, below.

As soon as the lead starts to fly, someone calls Lone Star. Five minutes after the first shot is fired, a Lone Star patrol car arrives to settle things down. Use the stats for the first carload of officers from **Armed and Dangerous**, p. 15. By the time any officers arrive, a smart team will have hit the road.

If the runners try to stop Meta or follow her, she shakes them off, telling them to contact Teague. She hands them a business card with his name and the LTG number 2206(12-3582).

If the runners try to contact Teague, go to the next scenario, **Brutal Ambush**.

## DEBUGGING

With Meta's help, a dedicated team should easily ice the Teddy Boys. If the runners appear to be on the losing side, The Mattresses' backup security can arrive to even the odds, or a corp patron may gather enough courage to stick his head up from cover long enough to put a couple of rounds into a few gangster skulls. This encounter demonstrates Meta's lethal skills, and reminds the team (once again) of Seattle's considerable dangers.

Meta comes through this shootout unharmed. The gamemaster should shamelessly fudge dice rolls to get this result (the Teddy Boys cannot shoot straight today). If, for some reason, the runners try to ice Meta, use the Teddy Boys to distract them.

If the team decides they have had enough of this scene, and decline to contact Teague again, get the story back on track by having Teague contact them. No matter who initiates the call, Teague sets up the meeting described in **Brutal Ambush**, with the same consequences.

## TEDDY BOYS (12)

Particularly unpleasant ork gangers, the Teddy Boys exist to frag up the system that they blame for their bleak lives. If they buy it in the process, that's fine, as long as they take a good-sized honor guard with them. Aping the "Teddy Boys" that ran the London streets in the 1960s, they wear bad knock-offs of Edwardian-style clothing in cheap synthetic velvet and satin, dripping lace.

<b>B</b>	<b>Q</b>	<b>S</b>	<b>C</b>	<b>I</b>	<b>W</b>	<b>E</b>	<b>M</b>	<b>R</b>	<b>Armor</b>
5	4	5	1	2	4	6	—	2	4/2

**Initiative:** 2 + 1D6

**Dice Pools:** Defense (Armed) 5, Defense (Unarmed) 3, Dodge 4 (**Threat/Professional Rating:** 2/2)

**Skills:** Armed Combat 5, Etiquette (Street) 3, Firearms 4, Unarmed Combat 4

**Gear:** Knife (2L1 [5L]), Lined Coat (4/2), Uzi III [SMG, 24 (clip) [BF], 4M3 [6M]]

CONDITION MONITOR		LIGHT STUN	MODERATE STUN	SERIOUS STUN	DEADLY STUN
STUN	1	1	2	3	Unc.
	2	2	3	4	Unc.
PHYSICAL	1	1	2	3	Unc.
	2	2	3	4	Unc.
	3	3	4	5	Unc.
	4	4	5	6	Unc.
		LIGHT WOUND	MODERATE WOUND	SERIOUS WOUND	DEADLY WOUND

**Teddy Boy 1**

CONDITION MONITOR		LIGHT STUN	MODERATE STUN	SERIOUS STUN	DEADLY STUN
STUN	1	1	2	3	Unc.
	2	2	3	4	Unc.
PHYSICAL	1	1	2	3	Unc.
	2	2	3	4	Unc.
	3	3	4	5	Unc.
	4	4	5	6	Unc.
		LIGHT WOUND	MODERATE WOUND	SERIOUS WOUND	DEADLY WOUND

**Teddy Boy 2**

CONDITION MONITOR		LIGHT STUN	MODERATE STUN	SERIOUS STUN	DEADLY STUN
STUN	1	1	2	3	Unc.
	2	2	3	4	Unc.
PHYSICAL	1	1	2	3	Unc.
	2	2	3	4	Unc.
	3	3	4	5	Unc.
	4	4	5	6	Unc.
		LIGHT WOUND	MODERATE WOUND	SERIOUS WOUND	DEADLY WOUND

**Teddy Boy 3**

CONDITION MONITOR		LIGHT STUN	MODERATE STUN	SERIOUS STUN	DEADLY STUN
STUN	1	1	2	3	Unc.
	2	2	3	4	Unc.
PHYSICAL	1	1	2	3	Unc.
	2	2	3	4	Unc.
	3	3	4	5	Unc.
	4	4	5	6	Unc.
		LIGHT WOUND	MODERATE WOUND	SERIOUS WOUND	DEADLY WOUND

**Teddy Boy 4**

CONDITION MONITOR		LIGHT STUN	MODERATE STUN	SERIOUS STUN	DEADLY STUN
STUN	1	1	2	3	Unc.
	2	2	3	4	Unc.
PHYSICAL	1	1	2	3	Unc.
	2	2	3	4	Unc.
	3	3	4	5	Unc.
	4	4	5	6	Unc.
		LIGHT WOUND	MODERATE WOUND	SERIOUS WOUND	DEADLY WOUND

**Teddy Boy 5**

CONDITION MONITOR		LIGHT STUN	MODERATE STUN	SERIOUS STUN	DEADLY STUN
STUN	1	1	2	3	Unc.
	2	2	3	4	Unc.
PHYSICAL	1	1	2	3	Unc.
	2	2	3	4	Unc.
	3	3	4	5	Unc.
	4	4	5	6	Unc.
		LIGHT WOUND	MODERATE WOUND	SERIOUS WOUND	DEADLY WOUND

**Teddy Boy 6**

CONDITION MONITOR		LIGHT STUN	MODERATE STUN	SERIOUS STUN	DEADLY STUN
STUN	1	1	2	3	Unc.
	2	2	3	4	Unc.
PHYSICAL	1	1	2	3	Unc.
	2	2	3	4	Unc.
	3	3	4	5	Unc.
	4	4	5	6	Unc.
		LIGHT WOUND	MODERATE WOUND	SERIOUS WOUND	DEADLY WOUND

**Teddy Boy 7**

CONDITION MONITOR		LIGHT STUN	MODERATE STUN	SERIOUS STUN	DEADLY STUN
STUN	1	1	2	3	Unc.
	2	2	3	4	Unc.
PHYSICAL	1	1	2	3	Unc.
	2	2	3	4	Unc.
	3	3	4	5	Unc.
	4	4	5	6	Unc.
		LIGHT WOUND	MODERATE WOUND	SERIOUS WOUND	DEADLY WOUND

**Teddy Boy 8**

CONDITION MONITOR		LIGHT STUN	MODERATE STUN	SERIOUS STUN	DEADLY STUN
STUN	1	1	2	3	Unc.
	2	2	3	4	Unc.
PHYSICAL	1	1	2	3	Unc.
	2	2	3	4	Unc.
	3	3	4	5	Unc.
	4	4	5	6	Unc.
		LIGHT WOUND	MODERATE WOUND	SERIOUS WOUND	DEADLY WOUND

**Teddy Boy 9**

CONDITION MONITOR		LIGHT STUN	MODERATE STUN	SERIOUS STUN	DEADLY STUN
STUN	1	1	2	3	Unc.
	2	2	3	4	Unc.
PHYSICAL	1	1	2	3	Unc.
	2	2	3	4	Unc.
	3	3	4	5	Unc.
	4	4	5	6	Unc.
		LIGHT WOUND	MODERATE WOUND	SERIOUS WOUND	DEADLY WOUND

**Teddy Boy 10**

CONDITION MONITOR		LIGHT STUN	MODERATE STUN	SERIOUS STUN	DEADLY STUN
STUN	1	1	2	3	Unc.
	2	2	3	4	Unc.
PHYSICAL	1	1	2	3	Unc.
	2	2	3	4	Unc.
	3	3	4	5	Unc.
	4	4	5	6	Unc.
		LIGHT WOUND	MODERATE WOUND	SERIOUS WOUND	DEADLY WOUND

**Teddy Boy 11**

CONDITION MONITOR		LIGHT STUN	MODERATE STUN	SERIOUS STUN	DEADLY STUN
STUN	1	1	2	3	Unc.
	2	2	3	4	Unc.
PHYSICAL	1	1	2	3	Unc.
	2	2	3	4	Unc.
	3	3	4	5	Unc.
	4	4	5	6	Unc.
		LIGHT WOUND	MODERATE WOUND	SERIOUS WOUND	DEADLY WOUND

**Teddy Boy 12**

# BRUTAL AMBUSH

## TELL IT TO THEM STRAIGHT

You dial the number Meta gave you and wait for the phone to ring. A flat voice answers, "Teague." When you identify yourself, his attitude suddenly changes.

"I'm glad you called," he says, reassurance flowing through the line. "I've been trying to get in touch with you. Sorry I couldn't return your calls, but I've been incredibly busy holding things together since Allenby's death. I assume you heard about that?"

"I don't blame you for being upset, or for looking after your own hides," he continues. "But whoever killed him did it too soon after I'd hired you for you to do much to prevent it. I'd like to keep you on the payroll to help me find the killer, though. I'll increase your retainer."

"We should meet. Come to Highstar's warehouse down by the docks. Be careful. I've heard that whoever geeked Allenby is looking for you next."

"The Highstar warehouse. One hour."

**If the runners decide to attend the meeting on the docks, read the following:**

The Highstar warehouse sits on one of the wharves along the north shore of Harbor Island. You've never been here before, but you know the place: seen one dock, seen 'em all.

The wharf seems deserted—no ships at the dock. You scan the area for Teague, and decide he must be inside.

And then all hell breaks loose.

## BEHIND THE SCENES

If the team can get a word in edgewise with Teague and ask him about Lone Star's warrant for their arrest, he claims Allenby's killer must have set up the false murder charges. He also denies knowing anything more about Allenby's death than they heard already. If they mention meeting Meta, Teague says, after a moment of silence, "Meta overstepped her authority somewhat. But I agree with her judgment. We'll discuss this further when we meet."

The address of Highstar's warehouse shows up in the public datanets: Pier 16, on the north end of Harbor Island.

## THE AMBUSH

Teague wants the runners dead. Lone Star screwed up their chance, and so he has hired some muscle to take care of this loose end. Even if some of the runners make it out alive, they discover Teague is not in the vicinity. He believes the wharf is a gauntlet too tough for the team to survive.

Two snipers lurk on top of the warehouse, and one occupies the easternmost crane at the wharf's north end. On top of the other crane at the north end, a street mage stands ready to add to the mayhem. Two low-skill street monsters wait inside the warehouse as back-up; as soon as the snipers open fire, they will burst onto the scene. To block the last obvious escape route, a car pulls across the south end of the wharf when the party begins. Three street thugs get out of the car and block that path to safety.

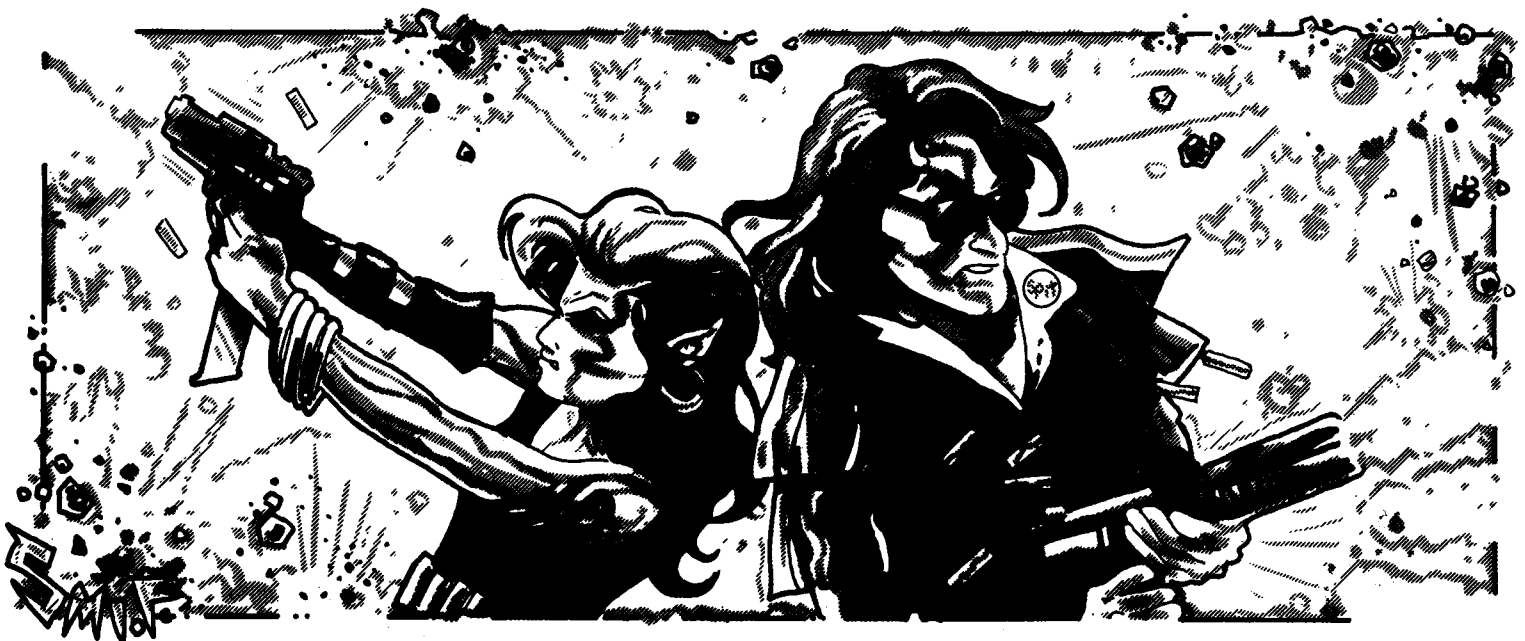

**BRUTAL AMBUSH**

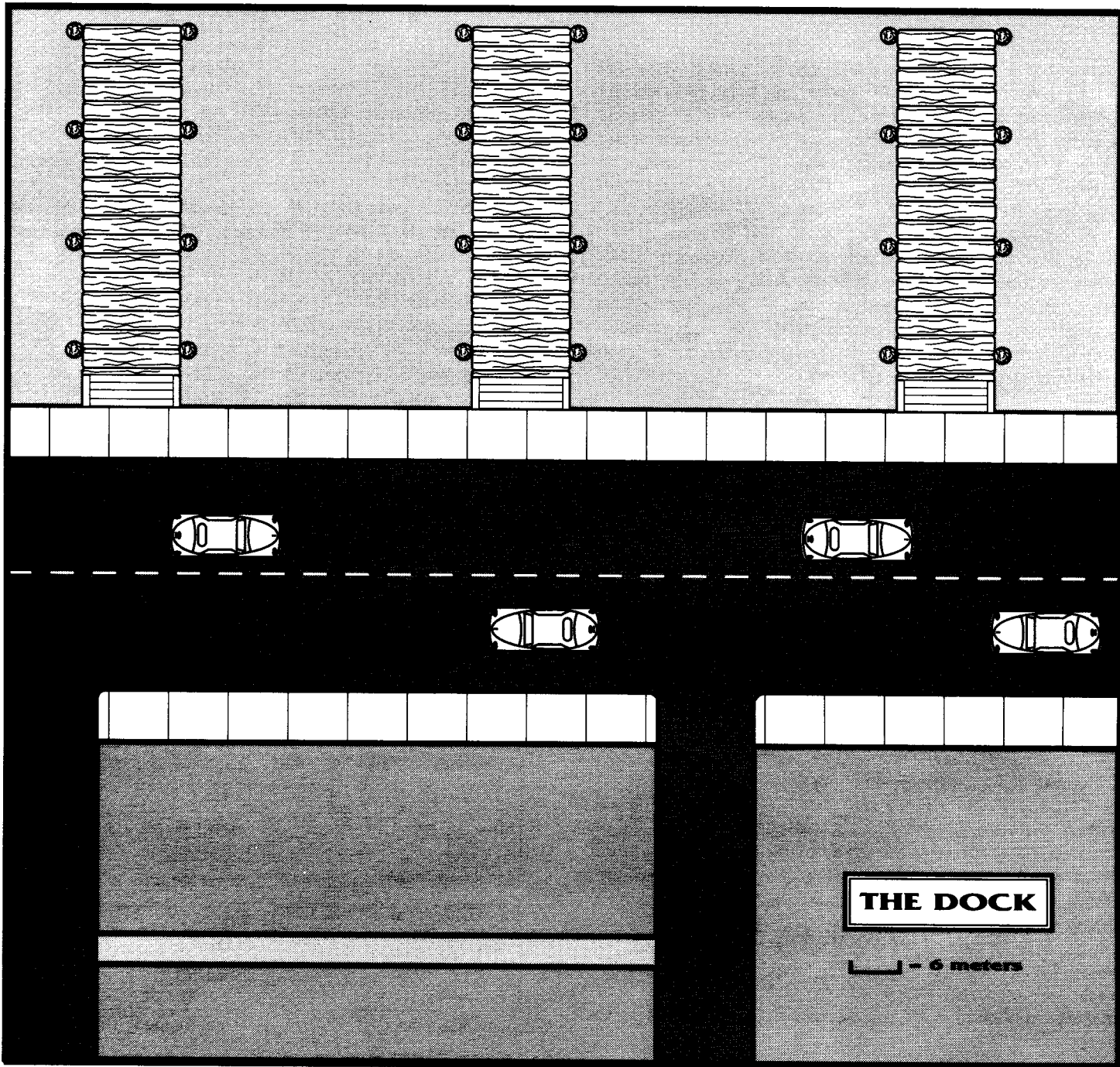

Make this ambush almost impossible to get out of gracefully. The runners may be forced into a fast swim in the oily waters of Elliot Bay as bullets slap the water around them. A brisk swim might also give the gamemaster the perfect chance to separate the team from any heavy weaponry they picked up. (It's tough to swim carrying a minigun, chummer, and don't let anybody tell you otherwise.) Escape across the water means the team left their wheels behind, and so it is a good day for scavengers.

At the last possible moment, have each character make a Perception (6) Test to notice anything unusual. If any character

achieves 2 or more successes, they suspect the trap just as the drek flies. One success means the characters lose the first Action of the Combat Turn. No successes leaves them surprised for the entire turn.

(Using **SRII** rules, any successes generated in the Perception (6) Test reduce the target number for each runner's Surprise test (see **Surprise**, **SRII**, p. 86). A runner who generates 2 successes uses a Target Number of 2. Modify the bad guys' target number by -2 for the ambush. The gamemaster may make Perception Tests to determine if the runners notice the snipers or the street mage.)

Now that they are wet, cold, and miserable, send the team **Off On A Tangent**.

**DEBUGGING**

A small or inexperienced team might have trouble surviving this encounter. If the characters appear likely to fall here, and the gamemaster wants to give them a break, fudge dice rolls to give the team the chance to swim for safety or otherwise give them an out.

Interrogating the muscle reveals only that their employer hired them through "channels," an untraceable link of fixers and other contacts. A halfway smart team should figure out who master-minded the plot.

By now, the team should be ready to tear Teague's heart out barehanded. But, as usual, he is unavailable by phone. No matter how angry they are, the runners still realize that invading Highstar is a useless venture, and they continue to hunt for Teague's home address without results. Their only reward for pursuing those avenues is a repeat attack by Lone Star.

**SNIPERS (3)**

These guys were born to pull the trigger. Not much good in a toe-to-toe fight, they ace the long-distance, one-shot takedown. If surviving runners come for them after the shooting, snipers slot and run.

<b>B</b>	<b>Q</b>	<b>S</b>	<b>C</b>	<b>I</b>	<b>W</b>	<b>E</b>	<b>M</b>	<b>R</b>	<b>Armor</b>
4	5	3	2	3	5	6	—	4	4/3

**Initiative:** 4 + 1D6

**Dice Pools:** Defense (Armed) 2, Defense (Unarmed) 2, Dodge 5  
**(Threat/Professional Rating: 3/2)**

**Skills:** Armed Combat 2, Etiquette (Corporate) 1, Etiquette (Street) 3, Firearms 4 (Sniper Rifles 6, Specialization: Walther WA-2100 8), Stealth 4, Unarmed Combat 2

**Gear:** Knife (1L1) (3L), Microtransceiver, Vest with plates (4/3), Walther WA-2100 Sniper Rifle [Sniper, 8 (magazine) (SA), 6S2 (14S), with Rating 3 low-light imaging scope and silencer]

**STREET MAGE**

Less willing even than the snipers to risk hand-to-hand action, the mage will cut and run if he suspects someone spotted him. He cast a sustained quickness +4 increase spell on himself before joining the party.

<b>B</b>	<b>Q</b>	<b>S</b>	<b>C</b>	<b>I</b>	<b>W</b>	<b>E</b>	<b>M</b>	<b>R</b>	<b>Armor</b>
2	5 (9)	2	2	5	3	6	4	5 (7)	4/2

**Initiative:** 5 (7) + 1D6

**Dice Pools:** Defense (Armed) 2, Defense (Unarmed) 2, Dodge 5, Magic 5

**(Threat/Professional Rating: 3/2)**

**Skills:** Armed Combat 1, Etiquette (Corporate) 2, Etiquette (Street) 2, Firearms 4, Sorcery 5, Stealth 2, Unarmed Combat 2

**Gear:** Colt America L36 [Light pistol, 11 (clip) (SA), 3M2 (6L)], Lined Coat (4/2), Microtransceiver

**Spells:** Fireball 4, Increase +4 (Quickness) 4, Power Bolt 4

**STREET SAMURAI (5)**

Unlike their comrades-in-arms, samurai willingly close with their targets if necessary to achieve the geek. No one can pay them enough to risk their own death, however, and they will abandon an indefensible position.

<b>B</b>	<b>Q</b>	<b>S</b>	<b>C</b>	<b>I</b>	<b>W</b>	<b>E</b>	<b>M</b>	<b>R</b>	<b>Armor</b>
5	5	5	1	2	4	1	—	3 (9)	5/3

**Initiative:** 3 (9) + 4D6

**Dice Pools:** Defense (Armed) 4, Defense (Unarmed) 3, Dodge 5  
**(Threat/Professional Rating: 3/2)**

**Skills:** Armed Combat 4, Etiquette (Street) 3, Firearms 5, Stealth 1, Unarmed Combat 3

**Cyberware:** Wired Reflexes (3)

**Gear:** AK-97 SMG [SMG, 30 (clip) (SA/BF/FA), 4M3 (6M), with Recoil Compensation 2], Armor Jacket (5/3), Microtransceiver, Survival Knife (5L3 (7L))

**LEYLAND-ROVER TRANSPORT (ELECTRIC)**

<b>Handling</b>	<b>Speed</b>	<b>B/A</b>	<b>Slg</b>	<b>APilot</b>
4/8	25/75	3/0	5	2

**Seating:** Twin bucket seats + 9 folding bench

**Access:** 2 standard + 1 double-sized + 1 hatch

CONDITION MONITOR									
	LIGHT STUN	MODERATE STUN	SERIOUS STUN	DEADLY STUN					
STUN	1 1/2	2	3	4	5	6	7	8	9
PHYSICAL	1 1/2	2	3	4	5	6	7	8	9
	LIGHT WOUND	MODERATE WOUND	SERIOUS WOUND	DEADLY WOUND					

Sniper 1

CONDITION MONITOR									
	LIGHT STUN	MODERATE STUN	SERIOUS STUN	DEADLY STUN					
STUN	1 1/2	2	3	4	5	6	7	8	9
PHYSICAL	1 1/2	2	3	4	5	6	7	8	9
	LIGHT WOUND	MODERATE WOUND	SERIOUS WOUND	DEADLY WOUND					

Sniper 2

CONDITION MONITOR									
	LIGHT STUN	MODERATE STUN	SERIOUS STUN	DEADLY STUN					
STUN	1 1/2	2	3	4	5	6	7	8	9
PHYSICAL	1 1/2	2	3	4	5	6	7	8	9
	LIGHT WOUND	MODERATE WOUND	SERIOUS WOUND	DEADLY WOUND					

Sniper 3

CONDITION MONITOR									
	LIGHT STUN	MODERATE STUN	SERIOUS STUN	DEADLY STUN					
STUN	1 1/2	2	3	4	5	6	7	8	9
PHYSICAL	1 1/2	2	3	4	5	6	7	8	9
	LIGHT WOUND	MODERATE WOUND	SERIOUS WOUND	DEADLY WOUND					

Street Mage

CONDITION MONITOR									
	LIGHT STUN	MODERATE STUN	SERIOUS STUN	DEADLY STUN					
STUN	1 1/2	2	3	4	5	6	7	8	9
PHYSICAL	1 1/2	2	3	4	5	6	7	8	9
	LIGHT WOUND	MODERATE WOUND	SERIOUS WOUND	DEADLY WOUND					

Street Samurai 1

CONDITION MONITOR									
	LIGHT STUN	MODERATE STUN	SERIOUS STUN	DEADLY STUN					
STUN	1 1/2	2	3	4	5	6	7	8	9
PHYSICAL	1 1/2	2	3	4	5	6	7	8	9
	LIGHT WOUND	MODERATE WOUND	SERIOUS WOUND	DEADLY WOUND					

Street Samurai 2

CONDITION MONITOR									
	LIGHT STUN	MODERATE STUN	SERIOUS STUN	DEADLY STUN					
STUN	1 1/2	2	3	4	5	6	7	8	9
PHYSICAL	1 1/2	2	3	4	5	6	7	8	9
	LIGHT WOUND	MODERATE WOUND	SERIOUS WOUND	DEADLY WOUND					

Street Samurai 3

CONDITION MONITOR									
	LIGHT STUN	MODERATE STUN	SERIOUS STUN	DEADLY STUN					
STUN	1 1/2	2	3	4	5	6	7	8	9
PHYSICAL	1 1/2	2	3	4	5	6	7	8	9
	LIGHT WOUND	MODERATE WOUND	SERIOUS WOUND	DEADLY WOUND					

Street Samurai 4

CONDITION MONITOR									
	LIGHT STUN	MODERATE STUN	SERIOUS STUN	DEADLY STUN					
STUN	1 1/2	2	3	4	5	6	7	8	9
PHYSICAL	1 1/2	2	3	4	5	6	7	8	9
	LIGHT WOUND	MODERATE WOUND	SERIOUS WOUND	DEADLY WOUND					

Street Samurai 5

VEHICLE CONDITION MONITOR									
	^	^	^	^					
	LIGHT	MODERATE	SERIOUS	DESTROYED					

Leyland-Rover Transport (Electric)

# OFF ON A TANGENT

## TELL IT TO THEM STRAIGHT

**If one of the runners carries a cellular phone, or the team has other access to a phone, they receive this information through a phone call. If not, the runners receive a written or E-mail message conveying the same information.**

Your telecom beeps. Over the past 24 hours, every call you took led to trouble. But you know you can't cut off contact with everyone, or you'll never get out of whatever you've got yourself into. You answer the phone.

The caller is a young woman who sounds vaguely familiar. "My name is Tangent. We met when you came to see my boss, Allenby. Remember?"

You remember a pretty, blonde woman with impossibly blue eyes.

"I have some important information for you," Tangent continues. "I don't want to meet with you," she adds hastily. "I'm underground, somebody already tried to kill me. But..." She sighs. "Frag it, I've got to do something."

"You probably already know that word on the street says you killed Allenby," she tells you. "I know he was still alive when you left his office. He chewed me out for not stopping you from going in. I tried to tell Lone Star that, but they wouldn't listen. Then somebody tried to kill me."

She hesitates for a moment, then continues. "I don't really know what to do. But I thought if I told you everything I know, you would know what to do."

"I found Allenby," she whispers. "Just sitting at his desk, still jacked into his computer. He spent the afternoon reviewing simsense demos. You know, amateur bands send them in, asking Allenby to represent them. Same stuff as usual. But when I went into his files to clear up loose ends, send out form letters, that kind of drek, I found out somebody wiped the whole demo directory. Deleted, totally blown away. He keeps a personal backup of everything he gets, but it's password-locked and I couldn't get in."

"I know it doesn't sound like much, but Allenby wouldn't slot the directory, so someone else must have."

She sighs again. "Oh yeah, I almost forgot. Right after you left, some military type who said he was a friend of yours came in and started asking questions. But he was asking about things a friend would have known, like your relationship with Allenby. I told him you didn't have one—I hope that was okay."

"I'm going to leave Seattle soon, before somebody tries to kill me again. I just wish I could be more help. Maybe you should talk to The Shadows—you know, the band. They know more about Allenby than anybody."

"A media producer named Blair Wickingham is throwing a party at his house in Matthews Beach. The Shadows will be there,

and you could meet and talk with them then. The party's invitation-only, but Wickingham sent Allenby a bunch of invitations. I can courier them to you, if you tell me where to send them.

"I'll be in touch again if I can." Tangent hangs up.



## BEHIND THE SCENES

Tangent's playing it straight with the runners, but they might still be suspicious—understandable, considering recent events. This is the first solid lead in this case, though, so they might be more willing to cooperate with Tangent.

If the team asks about the attempt on her life, the gamemaster should invent a suitably flashy story about a thug trying to geek her at home. Since her narrow escape, she has been staying with friends, keeping a low profile.

If the runners wonder how she got in touch with them, she truthfully tells them she got their number from her own street network. The gamemaster may need to drop some names of friendly mutual acquaintances to quiet the runners' suspicions. If the runners check with these people, they confirm her story.

Tangent describes Wallace perfectly if asked about "the military guy."

Tangent knows very little about Wickingham beyond his connections with one of the big entertainment networks. Plenty of rising stars, big names, and sycophants plan to attend the party.

Tangent sends the invitations to wherever the runners tell her. From here, go to *It's My Party*, the next section.

## DEBUGGING

This encounter should go smoothly. If the team refuses to talk to Tangent by phone, she tries to contact them by another route, then gives up. She does her best to talk them into going to Wickingham's party.





# IT'S MY PARTY

## TELL IT TO THEM STRAIGHT

So this is the lifestyle of the rich and famous. The invitations Tangent sent name a penthouse address in a twelve-story luxury block on the exclusive side of Matthews Beach. Two armed-and-armored security guards patrol the lobby. Two more figures appear to guard the elevators, but they're definitely not what you'd expect in high-class security. They look like bikers, decked in black riding leathers and sporting gang colors. You haven't seen the colors before: the logo looks like a cloaked grim reaper riding a chopped Harley. Interesting security they have here.

The guards at the door scrutinize your invitations very thoroughly. (Why, for frag's sake? You're wearing your best suit of armored clothing!) No forgeries, the guards reluctantly conclude. They "request" that you check your weapons before proceeding.

**If the team checks their obvious weapons with the guards without a fuss, read the following:**

The armored guards wave you through to the elevators. The bikers stare at you while you wait, ignoring any attempt you make at small talk.

The elevator car goes straight to the top floor. The building is laid out in four penthouse suites, one on each corner. You easily spot the party suite: the two black-leathered biker doormen give it away. They also stare at you as you walk into the suite.

The party's already in full swing. The young bright lights of Seattle have come to see and be seen. Sleazy producers, brain-dead leading men, willing starlets, and chipped-out musicians fill the room with the buzz of witty conversation and the tinkle of laughter. This is totally unfamiliar. You're used to the sounds of a roaring bike, or the stutter of an automatic weapon. The air reeks with perfume and the heady aroma of strange, smoking substances. Serving staff circulate with little hors d'oeuvres, petit fours, and trays of champagne. A drink-bearing waiter hesitates just slightly before offering you the tray.

The Shadows stand in a group near the sliding doors leading onto the patio. They're dressed like you, in street leathers, but without armor from the way their clothes hang. Sycophants and wannabes surround the band, each trying to catch and hold their attention. The band looks bored and uncomfortable. Parties like this are just the price of extreme and lavish wealth. You find it hard to feel sorry for them. Unfortunately, the mob around the band blocks your way at the moment. You decide to wait for a better chance.

You suddenly notice the music over the hubbub of conversation. Really dark, searing, soul-hurting stuff that you recognize as Jetblack's last, most depressing album.

**Once the runners have had a chance to absorb the party atmosphere, read the following:**

The music fades away, and conversation subsides. Everyone looks at The Shadows standing by the patio door, each holding a glass of champagne. The dark-haired lead singer—Marli Bremerton, you remember—speaks, her voice too loud for a human throat. "A toast," she says. "To absent friends, and to those who are no further away than sunset." The band members raise their glasses, down their drinks, then turn and shatter the glasses against the fake stonework beside the door.

The other guests look confused. Some try to repeat the toast, then everyone drinks. One or two also smash their glasses, then look embarrassed at their actions. As the servers clear up the broken glass, the noise of conversation returns to its previous level. "One Step Ahead of Death" comes back on, one of Jetblack's most gut-wrenching anthems to depression and fear. You sense something important just happened, but fragged if you know what.

**Before the team can approach the band, read the following:**

Movement near the penthouse door catches your eye, and you see new party guests arriving. An instant later, you recognize one of the faces: Teague.

Teague's eyes widen as he recognizes you in the same moment. He snaps a one-word command at his three escorts, and ducks back out the door. One of the escorts follows him; the other two stand in the doorway, waiting for you.

## BEHIND THE SCENES

For Wickingham's establishment, use the Large Residence Archetype from **Sprawl Sites**, p. 34. Both physical and Matrix security conform to luxury-lifestyle standards.

The building lobby has Rating 7 weapon detectors built into the doorframe, and the security guards insist that the team turn over all obvious weaponry before leaving the lobby. (Most guests may take in one "personal defense weapon," but the guards demand that street trash like the runners check *all* weapons.)

Give the team time to interact with the other party guests. Musician wannabes might assume the runners are part of a band ("What band are you with?"), while the spacey starlets might assume the male runners are actors ("Like, wiz, I mean, that armor stuff, it looks *real!*"). Others might decide that the runners are with the biker guards ("Great party, but you know, I'm sure there are crashers here.") Play up the mistaken identity bit for as long as everyone enjoys it.

When the band members make their strange toast, have each character make a Perception/Intelligence (4) Test. Any character achieving at least 1 success realizes that this toast is some sort of tradition among the band members.



## IT'S MY PARTY

Teague arrives flanked by two bodyguards (Daniel and Lester, from **Meet Mr. Johnson**, p. 9) and a wage mage. He spots the runners just as they spot him. Teague dashes for the elevator, the wage mage covering his retreat. The two bodyguards remain in the doorway to prevent the runners from following Teague, and open fire if the runners try to slip past them; they will use any means to stop them, and frag anyone unfortunate enough to step into the line of fire. (Major mayhem may occur here, with innocent partygoers stopping high-velocity rounds.) Teague and his wage mage take only four Combat Turns to dive into the elevator and head for the lobby. At the first sound of gunfire, security freezes the second elevator, leaving the fire stairs as the only exit for the runners to reach the ground level.

As soon as mayhem erupts, the two bikers charge in to protect The Shadows. The three guards inside the room, automatically assuming that the runners started the confrontation, will try to take them down.

It takes one minute, about 20 Combat Turns, for the elevator to reach lobby level, and another five Combat Turns for the mage to hustle Teague out the door to his waiting Rolls Royce Phaeton limo. Once Teague climbs aboard, the driver screeches off at top speed.

It takes the runners considerably longer than 20 Combat Turns to sprint down twelve flights of stairs. Assuming the bodyguards at the door to the penthouse failed to delay them significantly, they should reach the lobby in time to see the limo peeling out. If they manage to fight their way past the two bikers and two security guards in the lobby, yet another "equalizer" waits to ensure that Teague gets away: Meta, visible only as a shadowy figure in the bushes near the building's front door. The runners must make a successful Perception/Intelligence (9) Test to recognize her. She blazes a few rounds through the building's glass doors, more to keep the runners' heads down than to geek them, then takes off on her BMW Blitzen 2050 bike.

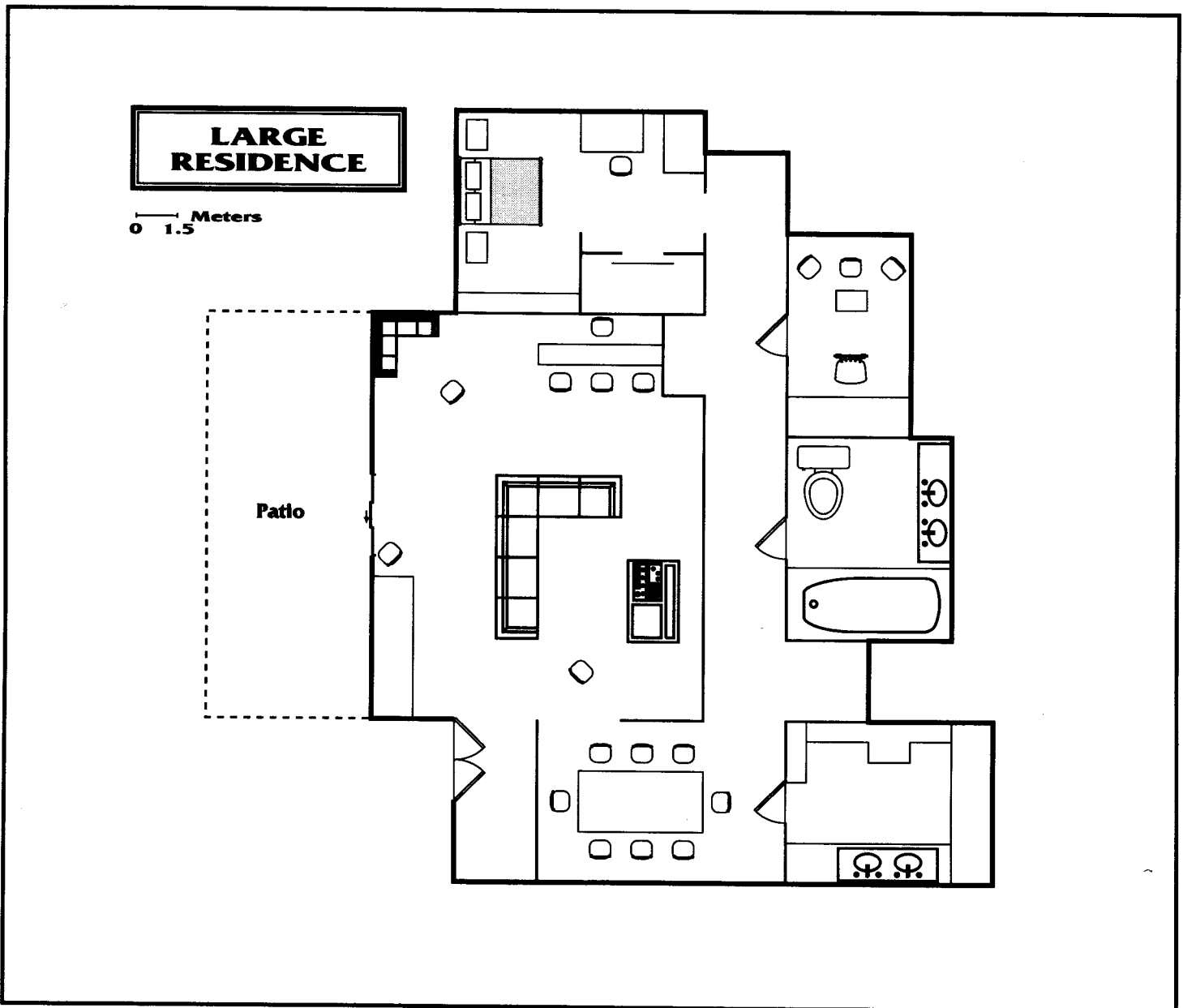

Predictably, when violence breaks out, somebody hits the PANICBUTTON. The first Lone Star patrol car arrives five minutes after the first shot was fired, or 100 Combat Turns, enough time for the runners to conclude their business and bug out. Use the stats for the first carload of officers in **Armed and Dangerous** for the first patrol to respond. The SWAT team's Citymaster arrives next, five minutes after the first car. Feel free to equip the law with whatever wizzer gear seems appropriate. Runners still around when the Citymaster arrives deserve everything they get.

Assuming the runners make it out of the building, go to **Under Surveillance**.

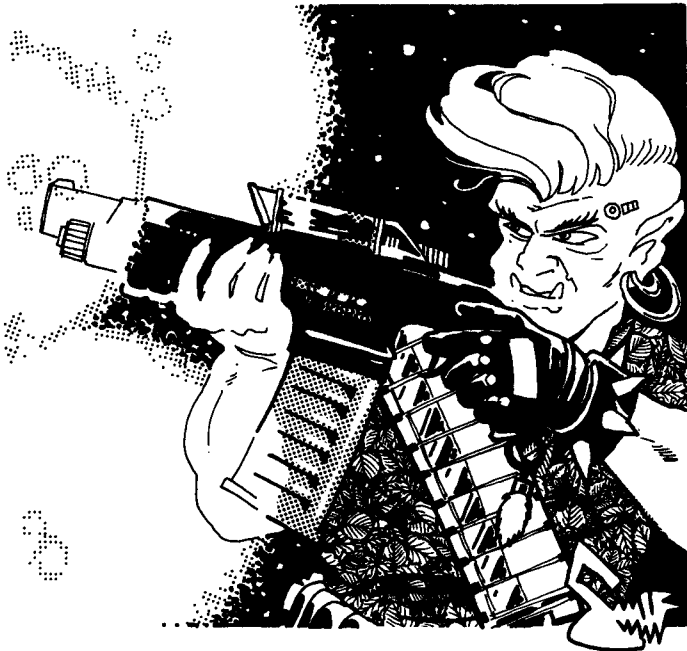

## DEBUGGING

The runners go through hell in this encounter. They simply cannot stop Teague (mainly because he must survive for the rest of the adventure). The wage mage provides defenses against spells, and the building security gauntlet keeps the team from getting a clear shot at their erstwhile employer. Use this encounter as a teaser, remind the runners that Teague is still out there, and refuel their anger at him. When they finally take him down, their revenge will be sweet.

If the runners somehow manage to catch Teague, they find they have snared his double. To make the deception convincing, Teague's real bodyguards cover the doppelganger, who only knows that his original lies in hiding somewhere. (Daniel and Lester briefed the double by showing him pictures of the runners, telling him to run like hell if he spotted them. He did.)

The runners should find themselves concentrating on getting out of the building in one piece. They start in the penthouse, twelve floors above street level, with no available elevators: security guards, bikers, Teague's wage mage, and Meta wait for them on the ground. The gamemaster must balance the game carefully to give the team even a small chance of surviving.

The gamemaster can manipulate several elements to help out the runners. While most of the guards assume that the leather-clad runners caused the trouble and try to shoot them, one or two people

in the penthouse noticed that Teague's entourage started the fracas. These people may shoot at the bodyguards. In the lobby, Teague's hasty departure might distract the security guards from noticing the runners scrambling down the fire stairs for at least a few Combat Turns. The wage mage might decide that the lobby guards questioned Teague a little too hard on his way out, and toast them. Such minor adjustments can make the difference between survival and ignominious death.

Obviously, the runners should beat feet before the cops arrive. Lone Star still wants them, dead or alive, for murdering Allenby, and would love to nail them for destroying Wickingham's penthouse as well. Lone Star might arrest the team instead of geeking them on sight; they might want to learn about the runners' part in the penthouse debacle rather than killing them out of hand. (After all, prisoners can always be shot while trying to escape.) Once in custody, the team gets one chance to escape, perhaps on the way to the Lone Star building downtown. If they blow that chance, Lone Star locks them away for a good long time, or worse.

Once they get away from the building, or escape from Lone Star, if necessary, the runners may try to get a line on the gang handling security for the party. To identify them by their colors alone, have the player characters make an Etiquette (Street) (4) Test; one success reveals the name of the gang as the Nightstalkers. To research the gang further, see **Legwork**, p. 52.

## PARTY STAFF

### Security Guards (2 in lobby)

Use the Street Cop Archetype (SR, p.171 [SR11, p.211]), with Stun Baton (5L3 [6S] Stun), Defiance Super Shock Taser [Taser, 4 (magazine), special [SS, 10S]], Fichetti Security 500 [Light Pistol, 22 (clip) [SA], 3M2 [6L]], and Armor Jacket (5/3).

### Bikers (2 in lobby, 2 outside suite)

Use Gang Boss Archetype (SR, p. 167 [SR11, p. 207]), with Intelligence 3, Willpower 3, and Etiquette (Street) 4. Drop Leadership Skill and add Bike 5. The bikers pack Ruger Super Warhawks [Heavy Pistol, 6 (cylinder) [SS], 4M2 [9M]], Knives (2L1 [4L]), and wear Lined Coats (4/2).

### Interior Guards (3, inside)

Use the Corporate Security Guard Archetype (SR, p.165 [SR11, p. 205]), with Defiance Super Shock Taser [Taser, 4 (magazine), special [SS, 10S]], Ares Slivergun [Heavy Pistol, 30 (clip) [SA/BF], 2M3 (flechette) [9S(f)]], and Armored Clothing (3/0). The guards are undercover, unsuccessfully masquerading as guests.

### Serving Staff (10)

Use Pedestrian (human) Archetype (**Sprawl Sites**, p. 116 [SRIIGM, p. 25])

{All bystanders have Professional Ratings of 1, going down after taking a Light wound, and so do not need Condition Monitors.}

### PARTY GUESTS (25)

Use Media Producer Archetype (SR, p. 169 [SR11, p. 209]), Club Habitué Archetype (**Sprawl Sites**, p.105 [SRIIGM, p. 14]), or Simsense Star Archetype (**Sprawl Sites**, p.118 [SRIIGM, p. 27]), as appropriate. (Largely bit players, they make terrific cannon fodder.)

# IT'S MY PARTY

Few carry weapons, and those who do will be too scared to do anything but hide behind a handy table or chair.

[All bystanders have Professional Ratings of 1, going down after taking a Light wound, and so do not need Condition Monitors.]

## TEAGUE'S STAFF

### Teague's Bodyguards (2)

Employed by Highstar but personally loyal to Teague, they protect their boss at all costs. They wear expensive corporate finery reinforced with armor. See stats for Daniel and Lester in **Meet Mr. Johnson**, p. 9.

### Wage Mage

She feels the same loyalty to Teague as the bodyguards, and is magically active. She is a Grade 1 Initiate, with a Centering Skill of declining her spells loudly in Greek.

**B Q S C I W E M R Armor**  
4 4 (7) 3 3 5 5 6 7 6 3/0

**Initiative:** 6 +1D6

**Dice Pools:** Defense (Armed) 2, Defense (Unarmed) 2, Dodge 7, Magic 7

**(Threat/Professional Rating: 3/3)**

**Skills:** Armed Combat 2, Etiquette (Corporate) 3, Etiquette (Street) 3, Firearms 4, Sorcery 5 (Spellcasting 7), Unarmed Combat 2

**Gear:** Armored Clothing (3/0), Knife (2L1 {3L}), Predator [Heavy Pistol, 15 (clip) {SA}, 6M2 {9M}]

**Spells:** Chaotic World 3, Mana Bolt 3, Manaball 3, Power Missile 5, Ram 4

### Driver

**B Q S C I W E M R Armor**  
3 5 3 4 4 4 3.75 — 4 (8) 4/2

**Dice Pools:** Defense (Armed) 2, Defense (Unarmed) 1, Dodge 8

**Skills:** Armed Combat 2, Car 4 (Passenger Vehicles 6, Specialization: R-R Phaeton 8), Etiquette (Corporate) 4, Etiquette (Street) 1, Firearms 3, Unarmed Combat 1

**Cyberware:** Radio, Vehicle Control Rig (2)

**Gear:** Beretta Model 200ST [Light Pistol, 26 (clip) {SA/BF}], 3M2 {6L}, capable of autofire (max 3 shots)], Lined Coat (4/2)

## VEHICLES

### Rolls Royce Phaeton

**Handling Speed B/A Sig APilot**  
4/4 60/180 5/2 {6} 2 4

**Seating:** Twin + 6 bucket seats + 3 folding

**Access:** 2 + 4 standard

### BMW Biltzen 2050

**Handling Speed B/A Sig APilot**  
3/4 95/285\* 3/2 {6} 1 2

**Seating:** 1 front + 1 rear

**Options:** 1 hardpoint mounted with forward-firing Ares MP LMG [Light MG, 50 (belt/bin) {BF/FA}, 5S3 {7S}]. When firing, Handling degrades to 4/5.

\*At speeds in excess of 210 kph, Handling becomes 4/5 (5/6 when LMG is firing).

CONDITION MONITOR									
	LIGHT STUN	MODERATE STUN	SERIOUS STUN	DEADLY STUN					
STUN	1 1st	2 2nd	3 3rd	Unc					
PHYSICAL	1 1st	2 2nd	3 3rd	Unc					
	LIGHT WOUND	MODERATE WOUND	SERIOUS WOUND	DEADLY WOUND					

### Security Guard 1

CONDITION MONITOR									
	LIGHT STUN	MODERATE STUN	SERIOUS STUN	DEADLY STUN					
STUN	1 1st	2 2nd	3 3rd	Unc					
PHYSICAL	1 1st	2 2nd	3 3rd	Unc					
	LIGHT WOUND	MODERATE WOUND	SERIOUS WOUND	DEADLY WOUND					

### Biker 1 (outside suite)

CONDITION MONITOR									
	LIGHT STUN	MODERATE STUN	SERIOUS STUN	DEADLY STUN					
STUN	1 1st	2 2nd	3 3rd	Unc					
PHYSICAL	1 1st	2 2nd	3 3rd	Unc					
	LIGHT WOUND	MODERATE WOUND	SERIOUS WOUND	DEADLY WOUND					

### Biker 1 (in lobby)

CONDITION MONITOR									
	LIGHT STUN	MODERATE STUN	SERIOUS STUN	DEADLY STUN					
STUN	1 1st	2 2nd	3 3rd	Unc					
PHYSICAL	1 1st	2 2nd	3 3rd	Unc					
	LIGHT WOUND	MODERATE WOUND	SERIOUS WOUND	DEADLY WOUND					

### Teague's Bodyguard 1

CONDITION MONITOR									
	LIGHT STUN	MODERATE STUN	SERIOUS STUN	DEADLY STUN					
STUN	1 1st	2 2nd	3 3rd	Unc					
PHYSICAL	1 1st	2 2nd	3 3rd	Unc					
	LIGHT WOUND	MODERATE WOUND	SERIOUS WOUND	DEADLY WOUND					

### Interior Guard 1

CONDITION MONITOR									
	LIGHT STUN	MODERATE STUN	SERIOUS STUN	DEADLY STUN					
STUN	1 1st	2 2nd	3 3rd	Unc					
PHYSICAL	1 1st	2 2nd	3 3rd	Unc					
	LIGHT WOUND	MODERATE WOUND	SERIOUS WOUND	DEADLY WOUND					

### Interior Guard 3

CONDITION MONITOR									
	LIGHT STUN	MODERATE STUN	SERIOUS STUN	DEADLY STUN					
STUN	1 1st	2 2nd	3 3rd	Unc					
PHYSICAL	1 1st	2 2nd	3 3rd	Unc					
	LIGHT WOUND	MODERATE WOUND	SERIOUS WOUND	DEADLY WOUND					

### Wage Mage

CONDITION MONITOR									
	LIGHT STUN	MODERATE STUN	SERIOUS STUN	DEADLY STUN					
STUN	1 1st	2 2nd	3 3rd	Unc					
PHYSICAL	1 1st	2 2nd	3 3rd	Unc					
	LIGHT WOUND	MODERATE WOUND	SERIOUS WOUND	DEADLY WOUND					

### Rolls Royce Phaeton

VEHICLE CONDITION MONITOR									
[10 empty boxes]									
A LIGHT		A MODERATE		A SERIOUS		A DESTROYED			

### BMW Biltzen 2050

VEHICLE CONDITION MONITOR									
[10 empty boxes]									
A LIGHT		A MODERATE		A SERIOUS		A DESTROYED			

# UNDER SURVEILLANCE

## TELL IT TO THEM STRAIGHT

**Gamemaster's Note:** This encounter can occur anytime that the team hits the streets after the party.

Have all characters make a Perception/Intelligence (5) Test. Read the following to the player who achieves the highest number of successes.

You get the feeling someone's watching you. You turn casually, trying to spot your tail.

A few blocks behind you, a leather-clad elf straddles a Yamaha Rapier. He idles by the side of the road, ogling the buxom blonde walking past him. He apparently doesn't notice you, but you're sure he was watching you a minute ago.

Something about the biker seems familiar, but it takes you a moment to realize it's his gang colors, emblazoned on the back of his jacket. A grim reaper riding a hog. You've last saw it on the gang that handled security at the media bash where you almost got geeked.

## BEHIND THE SCENES

Anytime the runners are out on the streets, have each character make a Perception/Intelligence (5) Test. The character generating the most successes (a tie goes to the player rolling closest to the target number) notices something. (In other words, somebody spots something; this test decides who, and can make the players think they missed something important.)

Most groups will do something about the ganger spy; take him out, lose him, tail him home, or capture him for a friendly discussion.

The biker watches the runners on orders from the gang boss. If the team threatens him in any way, he bugs out and runs for safety. If he loses the team, or if they spot him, he returns to the gang's home base, a deserted firehouse on Palatine Avenue North in the Bitter Creek neighborhood of northern Downtown. The young ganger is new to the surveillance game, and the thought that the people he followed might follow him in turn does not occur to him.

If the runners capture and question him, he will try to resist telling the team where his gang hangs out, but he knuckles under pressure, confirming that his gang is named the Nightstalkers. He tells them his name is Blaze. The runners cannot force Blaze to reveal his leader's name or any other information about him. Blaze has no idea why he is shadowing the team; he is only following orders. He admits that the Nightstalkers run security for The Shadows from time to time, and knows there is some connection between his boss and the band. If the runners show particular interest in this point, he offers to take the team to meet with his leader so they can talk things through. Privately, he believes that when he brings the team to the gang's hideout, his companions will cut them up.

This encounter should lead the runners to the Nightstalkers' hangout. Go to **The Nightstalkers**, p. 29.



## BLAZE

Blaze is a young, up-and-coming gang member, proud to wear the Nightstalkers' colors. His jacket's high collar conceals two puncture wounds about three centimeters apart on the side of his throat over the carotid artery. Blaze will die rather than reveal the secret of this "badge of honor" that every Nightstalker wears.

**B Q S C I W E M R Armor**  
4 5 3 3 3 4 6 — 4 4/2

**Initiative:** 4 + 1D6

**Dice Pools:** Defense (Armed) 3, Defense (Unarmed) 3, Dodge 5  
**(Threat/Professional Rating: 4/4)**

**Skills:** Armed Combat 3, Etiquette (Street) 3, Firearms 4, Stealth 2, Unarmed Combat 3

**Gear:** Browning Ultra-Power [Heavy Pistol, 10 (clip) (SA), 4M2 (9M), w/laser sight], Knife (1L1 {3L}), Lined Coat (4/2), Yamaha Rapier

CONDITION MONITOR									
LIGHT STUN		MODERATE STUN		SERIOUS STUN		DEADLY STUN		DIE	
STUN	1-1	2-2	3-3	4-4	5-5	6-6	7-7	8-8	9-9
PHYSICAL	1-1	2-2	3-3	4-4	5-5	6-6	7-7	8-8	9-9
	LIGHT WOUND	MODERATE WOUND	SERIOUS WOUND	DEADLY WOUND					

## DEBUGGING

If the team loses Blaze, or decides not to follow him, the gamemaster should run this encounter repeatedly until the team pays attention. Each time they go out on the street to do *anything*, they see the Nightstalker astride his bike, watching them. Eventually, the team will lose patience, and do something about the watcher.

The runners must eventually visit the Nightstalkers' headquarters in order to make progress in this adventure. If the team pays no attention to their tail, gets skunked trying to follow him, or simply kills him out of hand, the gamemaster can lure them to the meet some other way, perhaps slipping the location of the gang's hangout into conversation where appropriate.

# THE NIGHTSTALKERS

## TELL IT TO THEM STRAIGHT

You have reached your destination, a deserted fire station. The black-painted windows make the place look deserted, but light leaks around the big garage door, so you know somebody's inside.

As you approach, the garage door rolls up about six feet, spilling light into the street. A figure runs his bike through the door, then stands on the throttle. Echoes hammer back from surrounding buildings as he rockets away down the street. The door rolls down behind him, cutting off the light.

**When the team meets the leader of the Nightstalkers, read the following:**

Your leather-clad escorts lead you up the flight of stairs at the back of the fire station to the second floor. The interior is completely black, and you feel blind. Gun barrels prod you in the kidneys. You move forward slowly, feeling bedrolls and thin mattresses under your feet. When they're not capturing shadowrunners, the Nightstalkers must flop here.

Out of the darkness ahead of you comes a voice. "So, we have guests." The voice belongs to a young man. At first, it seems calm and well-modulated, but you recognize an underlying edge, the control of a professional speaker or performer. Just who *is* the gang's leader?

Cool blue light flares and surrounds the tall, slim figure of a young man like an aura. He wears tailored black leather. Glossy black hair falls to his shoulders, framing a slender face with high cheekbones and an elf-like complexion, though he's obviously human. He regards you with interest.

The realization hits you like a bullet-train. This is Jetblack. In the light of the magical nimbus surrounding him, you see him smile, his lips drawing back from noticeably enlarged eyeteeth.

**If the team convinces Jetblack that they want to find out who scragged Allenby, read the following:**

"I'll tell you about Allenby," the black-clad vampire says slowly. "He was a...you could call him a diary junkie, I guess. He recorded everything that happened to him, everything he thought—*everything*—in a private computer file." Jetblack smiles, an expression of fond remembrance that clashes with his threatening fangs. "He got paranoid about someone reading his stuff. At first, he kept the diary files encrypted, with ice on them. Then he went further. He had a friend modify the hardware architecture of his computer to conceal a particular system node. When you scan the system, you can't see it; it's not there. Even a decker can't get to it, because the data stream's invisible, and you can't travel what you can't see. That node takes a special system password."

The vampire appraises you. "I'd like to find out who geeked Allenby, too. You look like you could find out the truth; when you do, tell me, and if the fragger is still alive, I get first shot at him. My contribution now is the system password, Unruly."

## BEHIND THE SCENES

Use the Fire Station Archetype from page 23 of **Sprawl Sites** for the Nightstalkers' hangout. The upper floor is an open-plan dormitory. The only walls close off the washroom in the corner over the kitchen. The Nightstalkers park their bikes in the garage.

The runners can get into the fire station by several routes. They can try sneaking in through the back door or an upper floor window. The Nightstalkers expect them, however, and when the runners enter, the building appears dark and deserted. Once the team is inside, at least twenty Nightstalkers appear from hiding. (Enough gangers should appear to convince the runners not to resist.)

The team may decide to simply observe the fire station from a distance. While the team watches the station, twenty (or more) Nightstalkers watch the team. At some point, have a Nightstalker call out to the runners, perhaps saying, "Okay, that's enough. Make

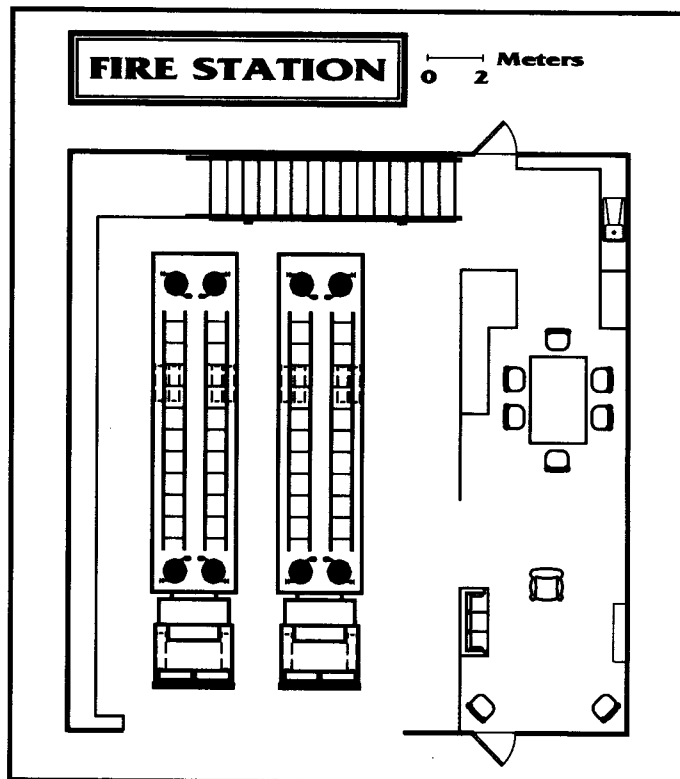



like Ice or we'll geek you where you stand." On the ganger's signal, the other Nightstalkers suddenly appear and surround the runners. Unless the team wants to play out a 2053-vintage version of Custer's last stand, they should accept the gangers' "invitation" to the fire station.

Whichever option they choose, the runners—or the survivors, if the team tried something unwise—walk into the darkened dormitory area above the fire station.

### NIGHTSTALKERS (20+)

The gangers are hard, competent, and dangerous. Each gang member carries the same puncture marks on his or her neck as Blaze.

<b>B</b>	<b>Q</b>	<b>S</b>	<b>C</b>	<b>I</b>	<b>W</b>	<b>E</b>	<b>M</b>	<b>R</b>	<b>Armor</b>
5	6	4	3	4	4	6	—	5	4/2

**Initiative:** 5 + 1D6

**Dice Pools:** Defense (Armed) 4, Defense (Unarmed) 4, Dodge 10  
**(Threat/Professional Rating: 4/3)**

**Skills:** Armed Combat 4, Etiquette (Street) 3, Firearms 5, Stealth 3, Unarmed Combat 4

**Gear:** Browning Ultra-Power [Heavy Pistol, 10 (clip) **{SA}**], 4M2 **{9M}**, w/Laser Sight], Knife (1L1 **{4L}**), Lined Coat (4/2). In addition, three Nightstalkers pack AK-97s [Assault Rifle, 38 (clip) **{SA/BF/FA}**], 5M3 **{8M}**, w/Laser Sight] and three more carry Uzi IIIs (SMG, 24 (clip) **{BF}**], 4M3 **{6M}**, w/Laser Sight].

### MEETING JETBLACK

Jetblack, the angst-ridden megastar reputed to have died several years ago, leads the Nightstalkers. He has become a vampire.

Jetblack feared death (see **Cast of Shadows**, p. 58). When a vampire offered him a way to escape from his greatest fear, the young singer jumped at it. He since regrets his decision, but cannot change it. Jetblack realized he could not continue his old existence in his new form. Some fanatic might try to destroy him, but more importantly, he might lead his fans into a decision that he now recognizes as an irreparable mistake. To avoid either fate, he faked his death and dropped out of sight.

The Nightstalkers know their leader's true nature. In fact, the scars each member bears on his or her throat indicates an intimate knowledge of Jetblack's condition. The gangers respect Jetblack and the protection he offers. Jetblack sees himself partly as a victim of his own fears, but mostly as a victim of society, and believes that society also victimized the Nightstalkers. Jetblack considers it his duty, and a penance for his pride, to guide and protect his charges.

Jetblack reveals very little of himself to the runners at their first meeting, but they eventually learn that Jetblack was a close friend of The Shadows, and has followed their career with great interest. When he faked his death, he let The Shadows know that he still lived, but told them nothing of his change. As far as Jetblack knows, the band thinks he went underground for personal reasons. In fact, the band knows much more, including that Jetblack is the "secret benefactor" who sends the Nightstalkers to provide them with personal security.

Jetblack became aware of the runners when they battled Teague's bodyguards at the party, and assumes they were actually interested in The Shadows. Jetblack constantly attempts to discourage such interest, and "invited" the runners to meet him in order to warn them off. "I want to know why you are hanging around The Shadows," he says quietly, showing his canines. "If you give me the wrong answer, I might well arrange it so you'll never look on the light of day again."

Jetblack's response depends on what the runners tell the vampire. Jetblack uses the spell Analyze Truth to check whatever they say. The team's best choice is to level with him and admit that they want to find out who killed Allenby and clear their names. Because Allenby used to be Jetblack's manager and friend, Jetblack respects this goal. (Jetblack did his best to prevent Allenby from learning about his metamorphosis, and believes that the dwarf died without learning his dark secret.) If the team convinces Jetblack that they mean The Shadows no harm, the vampire gives them the password to the dwarf's computer system.

After giving them Allenby's system password, Jetblack lets the runners go. To test the password, go to **Mindfield**, p. 31.

### DEBUGGING

If it looks like the team may escape (unlikely) or foolishly fight until overwhelmed by sheer numbers, feel free to have Jetblack appear. A powerful mage, he knows several spells that can knock the runners down without killing them. If necessary, fudge the dice rolls to stun the runners. They wake up bound and unarmed, upstairs in the fire station, ready for the interview with the vampire.

Jetblack takes no drek from the runners. Using an analyze truth spell, he spots any lie the runners tell, and can easily use his mind probe spell to dig out what he wants to know.

# MINDFIELD

## TELL IT TO THEM STRAIGHT

Right away, you find out that Allenby's personal computer system isn't hooked up to the Matrix; at least, you can't find a listing for it anywhere. You are left with only one option—a physical penetration of his offices.

**If a character decides to experience one of the simsense records on Allenby's system, read the following:**

You trigger the simsense demo recording and sit back to experience it. Too bad these Shadows wannabes don't have what it takes. Even the self-conscious, flashy production can't make musicians out of these hacks.

*What's that?* Something that doesn't belong seems to materialize in the simulated experience: a black shape, its eyes glowing red like burning embers. It reaches for you with a clawed hand...

## BEHIND THE SCENES

In order to get the information it needs, the team must break into the Caravan offices and use the password on Allenby's personal computer. This should be simpler than it sounds; with Allenby's death, Caravan effectively ceased to function as a business—not surprising, given that the late Allenby was the company's primary shareholder and officer, though the runners may not know it. The locked doors in the deserted offices sport yellow "Do Not Enter—Crime Scene" tapes, but no Lone Star officers stayed to enforce the prohibition. A Rating 5 maglock secures the Caravan suite's front door, and the door to Allenby's private office has a Rating 4 maglock. Any character searching for other security devices, such as alarms or motion detectors, will find them. Upon Allenby's death, Caravan stopped paying its bills, and the security companies disconnected all systems. Nothing stops the team from penetrating the offices.



Allenby's personal computer sits intact on his desk, waiting to be turned on. Anyone with a datajack can jack directly in. A character may also try to crack the system using the keyboard, but suffers the penalties described under *Tortoises in the Matrix* (SR, p. 111) and in *Virtual Realities*, pages 46-49. (For those characters who want to try life as a tortoise, Allenby's computer has the following programs on file: Bod 3, Sensors 2, Analyze 1, Evaluate 1, Browse 2 and Decrypt 2.)

## ALLENBY'S COMPUTER SYSTEM

### Computer System Map Key

**CPU** - Central Processing Unit

**DS** - Datastore

**I/OP** - Input/Output Node

**SM** - Slave Module

**SPU** - Sub-Processor Unit

**SAN-1:** Orange-3. This connection with the Matrix is hidden in the same way as DS-2. The dataline from CPU-1 to SAN-1 only appears in response to the system password "Charon." (This SAN, and the hidden connection, are described in *Charon*, p. 36. For the moment, the team decker does not know it exists.)

**CPU-1:** System CPU. Orange-3, Blaster 3, Trace and Report 7\*.

**SPU-1:** Graphics/numeric co-processor array. Green-2, Access 2.

**DS-1:** Primary datastore. Orange-3, Scramble 2, Blaster 3, Trace and Report 7\*\*. This datastore contains the Caravan Productions business records.

**DS-2:** Concealed datastore. Orange-3, Scramble 2, Blaster 3. The dataline from CPU-1 to DS-2 will only appear in response to the system password "Unruly." DS-2 contains the juicy information the runners want. For details on the contents, refer to *The Hidden Data*, below.

**I/OP-1:** Keyboard and terminal. Green-2, Access 2.

**I/OP-2:** Datajack connection. Green-2, Access 2.

\*The report this program creates seems to vanish one Combat Turn after being triggered. In fact, it travels down the hidden dataline to SAN-1, alerting Teague's decker, Himem, to potential trouble in the system. The team decker must destroy the report in one Combat Turn, or it vanishes.

\*\*This program sends a report to CPU-1. The report then vanishes down the hidden dataline to SAN-1. The decker has two Combat Turns to destroy the report before it vanishes.

The trace and report 7 ice in CPU-1 and DS-1 are far heavier than the security level of the rest of the system. If the team decker encounters either of these programs, have him or her make a Perception/Intelligence (4) Test. On a single success, the character realizes that someone added this ice to the original system security.

### The Hidden Data

The concealed datastore contains Allenby's diary files, plus backups of all of the files in Datastore 1 and some files erased from that datastore. A decker achieving 1 success on a Computer (4) Test figures the system out. Allenby set the system up to automatically back up all files in the main datastore to his second, hidden datastore as a security measure. Any files appearing in Datastore 2

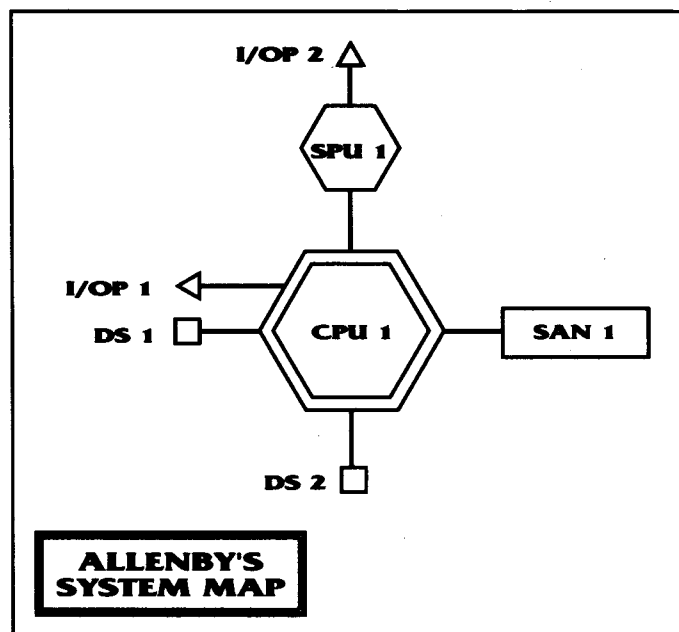

that are not in Datastore 1 were either created in the second datastore, like Allenby's diary, or are back-ups of files subsequently deleted from Datastore 1.

Datastore 2 contains three types of files: straight back-ups of the innocuous files in Datastore 1, Allenby's diary, and back-ups of files deleted from Datastore 1. The contents of each category appear in detail below.

**Daily Backup Files:** Bit-for-bit copies of the files the team's decker can find in Datastore 1, such as business reports and correspondence. They contain nothing about the matter at hand.

**Allenby's Diary:** Allenby's diary files for the past year alone take up more than 100 megapulses of data. Reading through all the files will take a character at least five hours, immersing him in the twisted, arrogant, passive-aggressive depths of Allenby's personality. Not fun.

Fortunately, a decker can use any word processor or program editor to search by key words for topics of interest. The most useful key words and the information associated with them follow: The Shadows—Massive amounts of information, specifically regarding Allenby's handling of their career and the vast sums of money they make for him; The Nightstalkers—Only a passing comment about "that gang was bodyguarding the Shadows again"; Jetblack—One comment: "Saw 'Jetblack Lives!' spraypainted on a building. Frag, he's dead, won't they ever believe it?"; Teague or Highstar—The jackpot. Entries dealing with Teague and his corporation consist largely of expletives, insults, and improbable speculations about Teague's ancestry and reproductive habits. By wading through the drek, the runners learn several important facts. First, Allenby owned Caravan. Second, Teague—fronting for Highstar—wanted to buy Caravan, and made Allenby an attractive offer. Allenby made it clear that Teague would get his grubby hands on Caravan over Allenby's dead body, and so, though this information gives Teague a juicy motive for having Allenby offed, none of it qualifies as proof. The runners must look elsewhere for evidence to tie Teague to the dwarf's death.



**Backups of Deleted Files:** Six backups in Datastore 2 do not match any files in Datastore 1. A decker can identify these files as simsense records by using a browse or evaluate program, each file about four minutes' worth of simsense data. On a successful Perception/Intelligence (4) Test, the browsing character remembers Tangent's remark that Allenby received piles of simsense demos from wannabe megastars, and always downloaded the data to his computer for later review. These simsense files are backups of the files Tangent said were missing from the primary datastore. (Remember, Tangent knew nothing about the secondary datastore.)

A decker penetrating Allenby's system can experience any of these simsense records by opening the appropriate file. The simsense data travels through his datajack directly into his brain. The decker can also download the records; he or anybody else can experience them later using a standard simsense 'trode rig. However, a nasty surprise awaits any character who decides to sample Allenby's simsense records.

### SIMSENSE TO DIE FOR

Having decided to kill Allenby, Teague chose a surprisingly subtle method. He turned to a decker in his employ, an unpleasant man who calls himself Himem. Teague knew Himem was working on methods of killing people by electronics, and so Teague gave Himem a chance to experiment by geeking Allenby.

For months, Himem dabbled with ways to booby-trap a simsense recording. Because a decker jacked into the Matrix experiences sensations virtually identical to simsense, a datajack connection gives the recording signals direct access to the brain. It ought to be possible, Himem reasoned, to booby-trap a simsense with black IC that triggers whenever the simsense plays. If the person playing the simsense has a datajack, the black IC can geek him as quickly as it can nail a decker; faster, in Allenby's case, because he lacked a decker's experience, knowledge, and reflexes. Someone scanning the record using 'trodes would probably only be hurt, not brain-fried. But Teague knew that the specific target, Allenby, always viewed his simsense demos through his datajack.

Using Highstar's resources, Himem established a concealed SAN connecting Allenby's system to the Matrix, hardwiring a tap from an LTG line into Caravan's computer system. Using this SAN, Himem planted the booby-trapped simsense in Allenby's computer. When Allenby played it, the black IC killed him. Himem then went back into the system, deleting the booby-trapped simsense and every other simsense record in the primary datastore to cover his tracks, but Allenby's computer had already automatically backed up the simsense records, including the rigged one, to the concealed secondary datastore.

The runners find the deadly simsense recording. If the decker runs the simsense while still jacked into Allenby's system, treat the situation as standard combat with Killer 4 black IC in an Orange-3 node. The decker may access any utilities stored in his cyberdeck, and use the deck's hardening as protection.

If a character views the simsense without the intermediary of a cyberdeck—for example, if the character plugs Allenby's system directly into his datajack and runs the simsense—a much more dangerous situation arises. As above, the character finds himself fighting Killer 4 IC in an Orange-3 node. But now he can only access

the utilities loaded on the system he is using. On Allenby's system, the character must use Bod 3, Sensors 2, Analyze 1, Evaluate 1, Browse 2 and Decrypt 2—not much use against killer IC. If the character plays the simsense on a system with *no* decker-style utilities, such as a standard home system, he might as well be running naked in the Matrix. The character's only viable alternative is to jack out immediately. To jack out, the character must achieve 1 success in an Unresisted Willpower (4) Test.

A character might decide to scan the simsense record using a 'trode playback rig. Simsense 'trode rigs offer only one-way communication, so the character wearing the rig cannot combat the IC attacking him. To save his skin, he makes an Unresisted Willpower (4) Test to jack out. A 'trode rig's comparatively low resolution prevents the black ice from doing its full damage. Because black ice inflicts mental, not physical, damage, once the character falls unconscious, he has jacked out.

### HIMEM STRIKES BACK

The runners face more than booby-trapped simsense. If the trace and report ice in either CPU-1 or DS-1 succeeds in sending its report to SAN-1, Himem knows someone is slotting around with Allenby's system. Rather than responding in person, he acts through intermediaries. Along with the booby-trapped simsense, Himem developed some interesting modifications to semi-autonomous black IC.

Five actions after the trace and report ice succeeds, Himem sends two copies of his modified Black-5 IC into SAN-1. One copy relocates to CPU-1, the other to DS-1. If they encounter a decker, the killer programs will attack. If not, they take up their assigned positions and wait for someone to stumble into their node, then attack. A team decker browsing through DS-2 when the IC arrives gets a nasty shock upon wandering back into presumably safe CPU-1 to find Black-5 IC waiting for him, drooling in anticipation.

Once the team decker succumbs to the black IC or jacks out safely, Himem deactivates the killer program he sent through SAN-1. Anyone visiting Allenby's system will find only the system's original, white IC.

The mysterious appearance of the black IC should alert the team decker that something is very wrong with Allenby's system, particularly if he or she sees the black IC emerge from the "wall" of CPU-1. Characters who need help getting the tip-off can make a Perception/Intelligence (4) Test. A single success reveals that Allenby's system has a second concealed dataline leading from CPU-1 to somewhere. As with the first concealed line, that hidden dataline cannot be accessed without the appropriate code word. (Sorry, chummer, nobody said this would be easy.)

### THE PHYSICAL RESPONSE

When Himem receives the warning from his trace and report ice, he dispatches the black IC to take out the decker messing with Allenby's system. But he knows that deckers rarely operate alone, and so he deploys a Highstar Security "Special Operations Team," consisting of seven gunners and a combat mage packed into a Volkswagen Superkombi III van, to charge into the Caravan offices and geek everyone inside. These heavies arrive in 10 minutes.

Survivors go to the next encounter, **Wallace Again**, p. 35.



## DEBUGGING

The only possible snafu here occurs if the team decker accesses the wrong data files and misses Allenby's diary, which reveals Teague's motive for wanting the dwarf dead. The team still makes it to the end of the adventure, but they remain in the dark about much of what is happening. The gamemaster could weigh in on the decker's side by having him or her make an Intelligence Test against a low target number to recognize significant files.

The runners will probably be gone from the Caravan building before the Highstar security team arrives. If the guards arrive while the team is still there, let the team develop as it may. If the runners look like they will get geeked, the gamemaster may throw in a couple of Nightstalkers, still shadowing the runners, to even the odds.

If the team captures a Highstar security guard alive, interrogation reveals nothing useful. Dispatch sent the guards to a particular address and told them to eliminate anyone they found there, without explanation and without identifying their targets.

### Highstar Security Operative (5)

Dedicated and well-trained, the security operative is a perfect blunt instrument for enforcing corporate policy. Though unwilling to throw his life away needlessly, he recognizes that risk comes with his job.

**B** **Q** **S** **C** **I** **W** **E** **M** **R** **Armor**  
5 6 5 3 3 4 3.2 — 4 (6)(+2D6) 6/5

**Initiative:** 4 (6) + 2D6

**Dice Pools:** Defense (Armed) 4, Defense (Unarmed) 4, Dodge 6  
{**Threat/Professional Rating:** 3/2}

**Skills:** Armed Combat 4, Etiquette (Corporate) 2, Etiquette (Street) 3, Firearms 5, Stealth 1, Unarmed Combat 4

**Cyberware:** Boosted Reflexes (3)

**Gear:** Knife (2L1 {5L}), Microtransceiver, Medium Security Armor (6/5), Samopal vz 88 V Assault Rifle [Assault Rifle, 35 (clip) {SA/BF/FA}, 5M3 {8M}, w/Laser Sight, gas-vent 2 recoil reduction, and shoulder stock (one additional level of recoil reduction)]

### Highstar Combat Mage (1)

She joined the corp to get free access to the hermetic libraries she would never see if she spent her life on the street. To enjoy this free access, she must remain alive, and so she takes no unnecessary risks.

**B** **Q** **S** **C** **I** **W** **E** **M** **R** **Armor**  
4 5 4 3 5 5 6 6 5 6/5

**Initiative:** 5 + 1D6

**Dice Pools:** Defense (Armed) 3, Defense (Unarmed) 3, Dodge 5, Magic 3 (5) (7)

{**Threat/Professional Rating:** 3/3}

**Skills:** Armed Combat 3, Etiquette (Corporate) 2, Etiquette (Street) 3, Firearms 3, Sorcery 3 (Spellcasting 5, Specialization: Combat Spells 7), Stealth 3, Unarmed Combat 3

**Gear:** Predator II [Heavy Pistol, 15 (clip) {SA}, 6M2 {9M}, w/Laser Sight], Knife (2L1 {4L}), Microtransceiver, Medium Security Armor (6/5), Specific Spell Focus (Powerball 2), Specific Spell Focus (Sleep 1)

**Spells:** {Heal 3}, Heal Severe Wounds 3, Mana Bolt 6, Powerball 6, Sleep 3, Ram 2

### Volkswagen Superkombi III (Commuter Model)

**Handling** **Speed** **B/A** **Sig** **APilot**  
4/8 35/105 4/1 {3} 2 3

**Seating:** 2 x 2 twin bucket seats + 10 folding bench

**Access:** 2 standard + 1 double-sized + 1 rear

COMBUSTION/FACILITY		COMBUSTION/FACILITY		COMBUSTION/FACILITY		COMBUSTION/FACILITY	
STUN	PHYSICAL	STUN	PHYSICAL	STUN	PHYSICAL	STUN	PHYSICAL
1-10	1-10	1-10	1-10	1-10	1-10	1-10	1-10
11-20	11-20	11-20	11-20	11-20	11-20	11-20	11-20
21-30	21-30	21-30	21-30	21-30	21-30	21-30	21-30
31-40	31-40	31-40	31-40	31-40	31-40	31-40	31-40
41-50	41-50	41-50	41-50	41-50	41-50	41-50	41-50
51-60	51-60	51-60	51-60	51-60	51-60	51-60	51-60
61-70	61-70	61-70	61-70	61-70	61-70	61-70	61-70
71-80	71-80	71-80	71-80	71-80	71-80	71-80	71-80
81-90	81-90	81-90	81-90	81-90	81-90	81-90	81-90
91-100	91-100	91-100	91-100	91-100	91-100	91-100	91-100

Highstar Security Operative 1

COMBUSTION/FACILITY		COMBUSTION/FACILITY		COMBUSTION/FACILITY		COMBUSTION/FACILITY	
STUN	PHYSICAL	STUN	PHYSICAL	STUN	PHYSICAL	STUN	PHYSICAL
1-10	1-10	1-10	1-10	1-10	1-10	1-10	1-10
11-20	11-20	11-20	11-20	11-20	11-20	11-20	11-20
21-30	21-30	21-30	21-30	21-30	21-30	21-30	21-30
31-40	31-40	31-40	31-40	31-40	31-40	31-40	31-40
41-50	41-50	41-50	41-50	41-50	41-50	41-50	41-50
51-60	51-60	51-60	51-60	51-60	51-60	51-60	51-60
61-70	61-70	61-70	61-70	61-70	61-70	61-70	61-70
71-80	71-80	71-80	71-80	71-80	71-80	71-80	71-80
81-90	81-90	81-90	81-90	81-90	81-90	81-90	81-90
91-100	91-100	91-100	91-100	91-100	91-100	91-100	91-100

Highstar Security Operative 2

COMBUSTION/FACILITY		COMBUSTION/FACILITY		COMBUSTION/FACILITY		COMBUSTION/FACILITY	
STUN	PHYSICAL	STUN	PHYSICAL	STUN	PHYSICAL	STUN	PHYSICAL
1-10	1-10	1-10	1-10	1-10	1-10	1-10	1-10
11-20	11-20	11-20	11-20	11-20	11-20	11-20	11-20
21-30	21-30	21-30	21-30	21-30	21-30	21-30	21-30
31-40	31-40	31-40	31-40	31-40	31-40	31-40	31-40
41-50	41-50	41-50	41-50	41-50	41-50	41-50	41-50
51-60	51-60	51-60	51-60	51-60	51-60	51-60	51-60
61-70	61-70	61-70	61-70	61-70	61-70	61-70	61-70
71-80	71-80	71-80	71-80	71-80	71-80	71-80	71-80
81-90	81-90	81-90	81-90	81-90	81-90	81-90	81-90
91-100	91-100	91-100	91-100	91-100	91-100	91-100	91-100

Highstar Security Operative 3

COMBUSTION/FACILITY		COMBUSTION/FACILITY		COMBUSTION/FACILITY		COMBUSTION/FACILITY	
STUN	PHYSICAL	STUN	PHYSICAL	STUN	PHYSICAL	STUN	PHYSICAL
1-10	1-10	1-10	1-10	1-10	1-10	1-10	1-10
11-20	11-20	11-20	11-20	11-20	11-20	11-20	11-20
21-30	21-30	21-30	21-30	21-30	21-30	21-30	21-30
31-40	31-40	31-40	31-40	31-40	31-40	31-40	31-40
41-50	41-50	41-50	41-50	41-50	41-50	41-50	41-50
51-60	51-60	51-60	51-60	51-60	51-60	51-60	51-60
61-70	61-70	61-70	61-70	61-70	61-70	61-70	61-70
71-80	71-80	71-80	71-80	71-80	71-80	71-80	71-80
81-90	81-90	81-90	81-90	81-90	81-90	81-90	81-90
91-100	91-100	91-100	91-100	91-100	91-100	91-100	91-100

Highstar Security Operative 4

COMBUSTION/FACILITY		COMBUSTION/FACILITY		COMBUSTION/FACILITY		COMBUSTION/FACILITY	
STUN	PHYSICAL	STUN	PHYSICAL	STUN	PHYSICAL	STUN	PHYSICAL
1-10	1-10	1-10	1-10	1-10	1-10	1-10	1-10
11-20	11-20	11-20	11-20	11-20	11-20	11-20	11-20
21-30	21-30	21-30	21-30	21-30	21-30	21-30	21-30
31-40	31-40	31-40	31-40	31-40	31-40	31-40	31-40
41-50	41-50	41-50	41-50	41-50	41-50	41-50	41-50
51-60	51-60	51-60	51-60	51-60	51-60	51-60	51-60
61-70	61-70	61-70	61-70	61-70	61-70	61-70	61-70
71-80	71-80	71-80	71-80	71-80	71-80	71-80	71-80
81-90	81-90	81-90	81-90	81-90	81-90	81-90	81-90
91-100	91-100	91-100	91-100	91-100	91-100	91-100	91-100

Highstar Security Operative 5

COMBUSTION/FACILITY		COMBUSTION/FACILITY		COMBUSTION/FACILITY		COMBUSTION/FACILITY	
STUN	PHYSICAL	STUN	PHYSICAL	STUN	PHYSICAL	STUN	PHYSICAL
1-10	1-10	1-10	1-10	1-10	1-10	1-10	1-10
11-20	11-20	11-20	11-20	11-20	11-20	11-20	11-20
21-30	21-30	21-30	21-30	21-30	21-30	21-30	21-30
31-40	31-40	31-40	31-40	31-40	31-40	31-40	31-40
41-50	41-50	41-50	41-50	41-50	41-50	41-50	41-50
51-60	51-60	51-60	51-60	51-60	51-60	51-60	51-60
61-70	61-70	61-70	61-70	61-70	61-70	61-70	61-70
71-80	71-80	71-80	71-80	71-80	71-80	71-80	71-80
81-90	81-90	81-90	81-90	81-90	81-90	81-90	81-90
91-100	91-100	91-100	91-100	91-100	91-100	91-100	91-100

Highstar Combat Mage

### Volkswagen Superkombi III (Commuter Model)

VEHICLE CONDITION MONITOR									
1	2	3	4	5	6	7	8	9	10
▲	▲	▲	▲	▲	▲	▲	▲	▲	▲
LIGHT	MODERATE	SERIOUS	DESTROYED						

# WALLACE AGAIN

## TELL IT TO THEM STRAIGHT

**Gamemaster's Note:** Use this encounter any time after the team first penetrates Allenby's computer system, whenever the runners hit the street.

It's raining again, no fragging surprise, heavily enough to cut visibility down to a few tens of meters. Out of the curtains of rain, a big man materializes, holding empty hands out to his sides to show he's unarmed. You recognize Wallace immediately.

"We need to talk," he says flatly. "And you need it more than I do. Pick a place, somewhere private."

## BEHIND THE SCENES

Wallace, the FBI contractor and walking cyberware emporium, follows the team to whatever meeting place they pick. His willingness to follow them into what could be an ambush should impress the runners with either his confidence, or his toughness.

Wallace levels with the team. He works for a special FBI task force investigating corruption and collusion within the entertainment industry. (Considering that a few major megacorps own and control 98 percent of the world's news media, potential collusion worries the feds.) The task force assigned Wallace to ferret out Allenby's and Caravan's possible involvement in this worldwide scam. Initially, he believed the runners worked for Allenby and Highstar, possibly as liaison between the two corporations.

Allenby's death proved Wallace's first guess wrong. After some digging, Wallace discovered Highstar's offer to buy out Caravan, and that Allenby turned it down. That put Caravan in the clear, and Wallace out of an official assignment. He believes Highstar murdered Allenby in order to take over Caravan. But neither Highstar nor murder lies within Wallace's jurisdiction: the department has no interest in, or jurisdiction over, homicide cases, even though Wallace feels a personal sense of injustice. The FBI assumes Wallace will take the party line of FIGMO—"frag it, I got my orders," but he wants *somebody* to take down Teague and Highstar.

He implies that if the runners dig up some real dirt on Highstar, or do something unpleasant to Teague, he will pull strings to clear them of killing Allenby.

"I know you guys have seen Allenby's files," he concludes, "and I think you found the door that wasn't there. The word of the day is 'Charon'. Put it to good use." With that, Wallace takes off again, blending into the scenery.

Wallace's comment about "the door that wasn't there" clearly refers to the hidden dataline from CPU-1 to SAN-1 in Allenby's system. "The word of the day" refers to the password that reveals and allows access to that dataline.

## DEBUGGING

The team might try to persuade Wallace to do more toward getting them off the hook for Allenby's murder. Unfortunately for them, even an agent has his limits, and he cannot easily do that. Homicide is clearly outside his jurisdiction, and Wallace would have to personally appeal to his superior in Washington, DC, in order to clear the runners. Understandably, he is reluctant to do so without a fragging good reason. Holding him hostage to get their way only earns the team the FBI's displeasure, in addition to Lone Star's existing desire for their incarceration. The team foolish enough to keep Wallace on ice receives a visit from an FBI Fast Response Team. Gamemasters can use any stats for the members of this team. Remember that the Feds mean fragging business; a team of two-bit shadowrunners has no hope of taking them on and winning.

If the team decides to do random violence and kill Wallace without hearing him out, Jetblack may learn the "Charon" password from one of his sources, and so the gamemaster can give the team a second chance.



# CHARON

## TELL IT TO THEM STRAIGHT

Okay, back to Allenby's office. You're moving even more carefully this time, because who knows what corporate security goons decided to stay behind?

## BEHIND THE SCENES

Caution pays off. Highstar left one security operative behind in Caravan's outer office to watch the place, but only one, because the people at Highstar never imagined the team would be stupid enough to come back. Use the statistics from *Mindfield* for the remaining security goon. He fights hard, but surrenders before the team kills him.

Allenby's computer system looks exactly like they left it, except that Hlmem's modified black ice no longer exists in CPU-1 or DS-1. The decker can reenter the system either by decking in or running as a tortoise. (See *Mindfield*, p. 32.)

For the system layout, refer to the map of Allenby's computer system on p. 32. When the team decker uses the system password

"Charon," the dataline between CPU-1 and SAN-1 becomes visible, and the decker can travel freely to SAN-1. A second dataline leads from SAN-1 to part of the Highstar corporate computer system.

If the team decker triggers an external alert, or if the trace and report IC successfully executes its function, Hlmem discovers an intruder in his private area of the system. A typically egotistical decker, Hlmem jumps into the system and fights toe-to-toe with the team decker. Hlmem's arrogance frequently prevents him from recognizing a losing position; he would rather die than cut and run.

## HIGHSTAR COMPUTER SYSTEM MAP KEY

**SAN-1:** Orange-3. This node showed up on the map of Allenby's system.

**SAN-2:** Orange-4, Killer 3, Tar Pit 3. This node provides access to the Matrix.

**CPU-1:** Orange-3, Tar Baby 4, Barrier 5. This CPU provides most of the Highstar system's horsepower.

**SPU-1:** Red-3, Blaster 4, Trace and Burn 4. This newly installed SPU manages the link between the Highstar and Caravan systems.

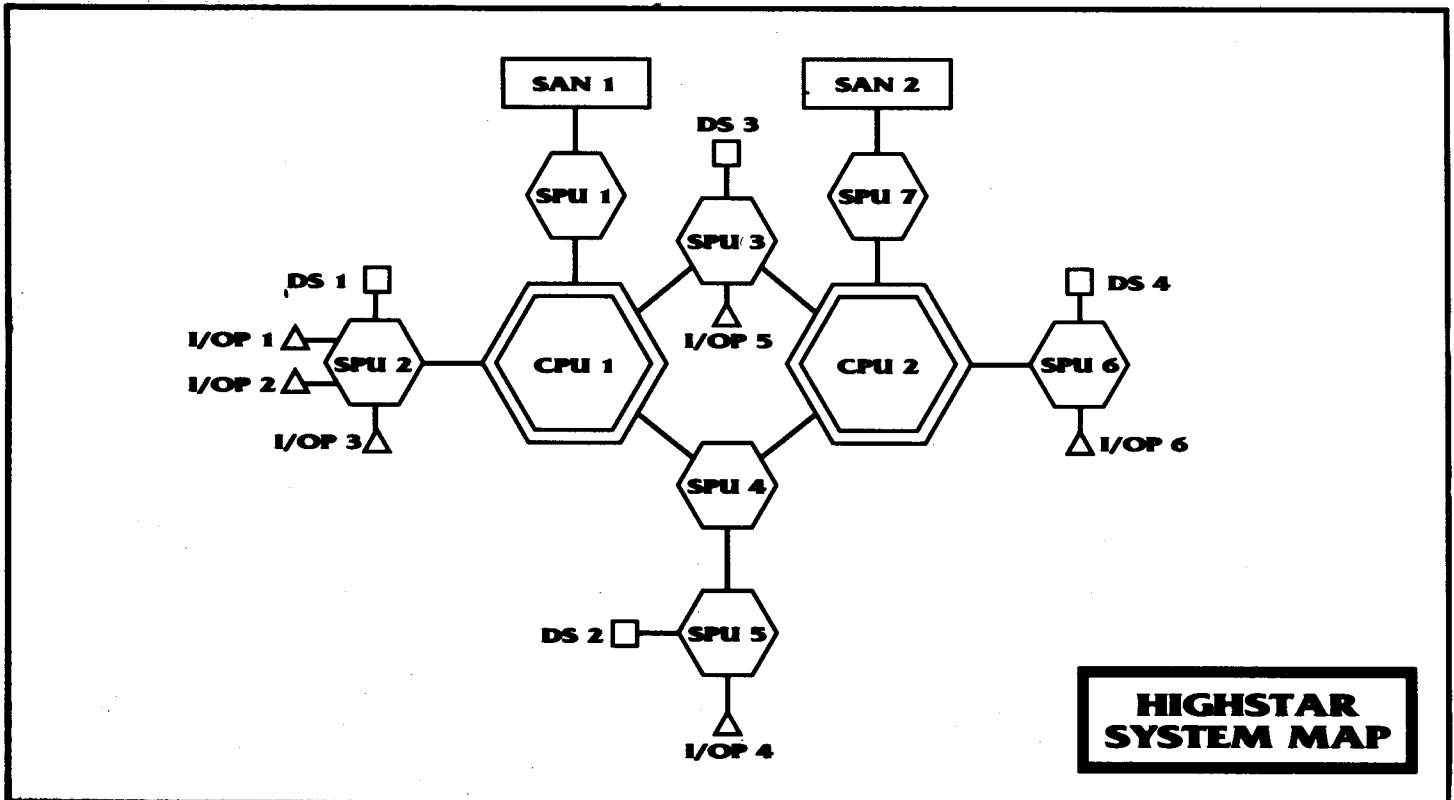

**SPU-2:** Orange-3, Barrier 4. This processor belongs to the accounting department.

**DS-1:** Orange-3, Barrier 3, Scramble 3. Contains basic accounting information concerning Highstar's operations, which reveals that Highstar operates as a shell company.

**I/OP 1-3:** Green-3, Barrier 2. These nodes represent terminals and datajack connections in Highstar's accounting department.

**SPU-3:** Red-3, Barrier 4, Killer 3. The "executive" SPU, dedicated almost exclusively to Teague's personal use.

**DS-3:** Red-2, Barrier 3, Scramble 3, Black-4. Contains various files describing Teague's attempts to take over Caravan, plus a report from private investigators on Allenby's vulnerability to blackmail. Nothing here proves that Teague engineered Allenby's death, but the Machiavellian maneuvering described in these files would certainly trash both Teague's and Highstar's reputations if publicized. The right buyer might offer 10,000 nuyen for these files. This paydata takes up 25 Mp of storage.

**I/OP-5:** Red-2, Barrier 4. Teague's office terminal.

**CPU-2:** Orange-3, Tar Baby 4, Barrier 5. This back-up CPU offloads work from CPU-1, but mainly supports Himem's research, conducted in SPU-6.

**SPU-4:** Orange-3, Barrier 3. Manages traffic between CPUs 1 and 2.

**SPU-5:** Orange-4, Barrier 4, Trace and Burn 3, Killer 3. Dedicated for Personnel's use.

**DS-2:** Red 2, Barrier 3, Scramble 3, Blaster 3. Contains personnel data, including Teague's home address: Vashon Heights on the north tip of Vashon Island, just west of south downtown Seattle.

**I/OP-4:** Orange-3, Barrier 3. A Personnel Department terminal.

**SPU-6:** Red-4, Barrier 4, Trace and Burn 3, Tar Pit 3, Trace and Report 8, Killer (Black-4). This SPU contains Himem's research.

**DS-4:** Red-4, Barrier 4, Scramble 4, Trace and Report 8, Black-5. This datastore contains records and sample computer code for Himem's research into modified black ice. A few files written in Himem's private code deal with his booby-trapped simsense experiments. The files referring to modified black ice comprise 100 Mp, worth 50,000¥ to the right buyer, but only as a complete set. Fragments of these files net about 1,000¥ per 10 percent of the data the decker retrieved. (Saved only half of the data? Worth 5,000¥, chummer.) The files discussing the booby-trapped simsense must be decrypted before they can be read (or sold), requiring an Intelligence (8) Test and 24 hours base time. When decrypted, the files comprise 150 Mp. Sold complete to the right buyer, they net 200,000¥. Fragments bring about 2,000¥ per 10 percent of the data. Half of this data sells for 10,000¥. In both cases, the total value of the information diminishes by 10 percent for each week the runners hold it.

**I/OP-6:** Red-3, Barrier 5. A datajack connection in Himem's research lab.

**SPU-7:** Orange-4, Barrier 6, Tar Baby 3. This SPU manages SAN-2, monitoring all traffic between Highstar's system and the Matrix.

**HIMEM**

Twenty-three years young, Himem the *wunderkind* can whip up nasty ice and hold his own in a decker dogfight. His icon is a Three Musketeers-vintage fop wielding an épée that glows with the red light of a CO<sub>2</sub> laser.

<b>B</b>	<b>Q</b>	<b>S</b>	<b>C</b>	<b>I</b>	<b>W</b>	<b>E</b>	<b>M</b>	<b>R</b>	<b>Armor</b>
2	6	2	1	6	3	5.5	—	6 (12)(+3D6)	—

**Initiative:** 6 (12\*) + 1D6 (3D6\*) (\*Matrix only)

**Dice Pools:** Defense (Armed) 1, Defense (Unarmed) 1, Dodge 6, Hacking 12

**(Threat/Professional Rating: 4/3)**

**Skills:** Armed Combat 1, Computer 4 (Software 6, Specialization: Matrix Programming 8), Computer Theory 6, Computer (B/R) 5, Electronics 5, Etiquette (Corporate) 2, Etiquette (Street) 1, Stealth 1, Unarmed Combat 1

**Gear:** Fairlight Excallbur cyberdeck (MPCP 12, Hardening 5, Memory 500, Storage 1,000, Load 100, I/O 50; with increased response (3))

**Programs:** Bod 6, Evasion 4, Masking 3, Sensors 6, Attack 7, Browse 3, Deception 3

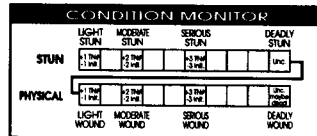

Himem

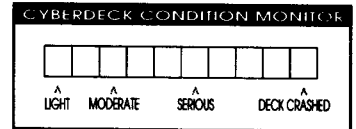

Highstar Security

**HIGHSTAR SECURITY**

Before diving brain-first into the Matrix to scrap it out with the intruding decker, Himem will order the Highstar Special Ops Team back to Caravan. Use the stats from **Mindfield**, p. 34. This time, however, the Special Ops boys and girls show up in seven minutes, fast enough to catch runners who take too long to get in and out.

From here, move on to **Aid from The Vampire**.

**DEBUGGING**

The team must discover Teague's private home address in this venture. The information about Teague's takeover attempts and Himem's booby-trapped simsense fills in gaps in the runners' understanding, but it is not essential to their work. If the team fails to get Teague's address from the Highstar computer system, they must find it elsewhere, in a way determined by the gamemaster. Jetblack may have done his own research, and can pass his results on to the team in the next encounter. Wallace may contact them again, insulting them for not searching the system well enough and giving them Teague's address.

The Nightstalkers again may show up to save the team's butts from the Highstar Special Ops Team.

If the team is tempted to immediately fence any paydata they scam from Highstar's system, the gamemaster should subtly remind the team, based on the makeup of the assassination team at the docks, that Teague willingly hires killers from the shadows. He already spread the word (and the nuyen) that the player-character team pays more dead than alive, and so any meet with a fence or fixer represents a potential setup. The runners may figure this out on their own. If not, their first meet with a fixer turns into an inept ambush, to give them a chance to figure out what is going on. If they continue trying to fence the data, make the ambushes progressively lethal until they get the hint. To get out from under the mess they are in, the team must take down Teague. (Generous gamemasters might allow players to make Intelligence (6) Tests for their characters to figure out the situation.)

# AID FROM THE VAMPIRE

## TELL IT TO THEM STRAIGHT

Seems you can't win for losing these days. You keep going over the same ground, getting beat up by the same things; now you've got paydata and you can't get rid of it and stay alive. Something's got to give, and it's not going to be you.

## BEHIND THE SCENES

Okay, so the runners know Teague's bolt hole, and they know they have to take the man down to return to a normal life. This will be hard, because Teague designed his holiday home as a fortress, as a little effort on the runners' part reveals. (see *Legwork*, p. 52). The team cannot penetrate Teague's security alone, and attempting to hire muscle from the shadows simply invites assorted assassins to take their best shots at the runners. Clearly, the team needs help from an unconventional source.

The players might think to go to Jetblack for muscle. Jetblack distrusts the runners no more than he does anyone else, and though he refuses to help them overtly for personal reasons, he agrees to talk to them.

Of course, the team may not consider Jetblack a potential resource, in which case Jetblack contacts them to ask what they found in Allenby's system. (He refers to the *first* run, of course.) If the team tells him what they found, he repeats that Teague must be taken down. If the runners still fail to see that they must take down Teague, Jetblack tells them that Teague placed a price on their heads, and that several shadowy hitters already plan to track the team prior to geeking them. If the team does not know Teague's personal address by now, Jetblack provides it at this time.

Once the runners decide to get rid of Teague and find out what they face at his defended home, they realize that the team alone is not enough to break in and do the job. The team may ask Jetblack for help, if only to provide several Nightstalkers as back-up.

Jetblack refuses their request for personal reasons. Getting his gang involved in a high-profile operation like raiding a corporate safehouse would focus attention on the Nightstalkers, making it all but impossible for Jetblack to maintain the secret of his faked death and his identity as a vampire. His old friends The Shadows will certainly hear the true story, and Jetblack fears that The Shadows will despise him for trying to cheat death by accepting vampirism. He cannot bear to risk their hatred. (Though illogical, Jetblack's fear is understandable. He has always been emotionally insecure. See *Cast of Shadows*, p.58.)

If the team wants Jetblack's help, they need to convince him that The Shadows either will not learn of his vampirism, or that they will not care. Jetblack's fear verges on paranoia; even the slightest

chance of his secret becoming public is too great for him to risk helping the runners. Therefore, the team needs to convince him that his old friends will not hold his condition against him, or that they already know.

Though they might not remember, the team already has evidence that The Shadows know about Jetblack. At the party, The Shadows offered a toast, "to absent friends, and to those who are no further away than sunset." The "sunset" line could well refer to a vampire, given their allergy to sunlight, and would at least imply that The Shadows know Jetblack is a vampire. (After all, how many vampiric friends could the band members have?)

If the players fail to recognize this key piece of information, the gamemaster can have each player make an Intelligence (4) Test to recall the words of the toast, and that Jetblack's music played incessantly at the party. Intelligent players should be able to work out the significance of the toast from there. A generous gamemaster can give less astute players a second chance to make the connection and conclude that the band knows about Jetblack's vampiric condition, and accepts it.

If the team argues their case convincingly, Jetblack buys their theory and agrees to help the runners. Still scared by the idea of meeting his old friends face-to-face, Jetblack suggests that the team come with him to talk to The Shadows, currently hanging out in the home of another musician in Richmond Highlands. If they agree to come to the meeting, Jetblack rides with the runners, and ten Nightstalkers accompany them on bikes. If the team goes to the meet, go to **Shadows in the Shadows**. (Jetblack will only go to a night meet.)

## DEBUGGING

If the team cannot convince Jetblack to help them out directly, and he will not tell them where to find The Shadows, they cannot appeal to the band for help. In this case, the team needs to find back-up elsewhere.

They can hire some street muscle, if they can find street ops willing to help them rather than kill them for Teague's bounty; a difficult and unlikely task. (If the team chooses this option, the gamemaster decides the difficulty and danger of the task, and the quality of muscle available.)

They can try to contact The Shadows by other means, perhaps hoping that the rich musicians might hire some back-up for them. This option appears (and should be) virtually impossible. The team cannot talk to The Shadows directly, only to their assistants, flacks, or groupies. Good flacks (and The Shadows have the best) keep metalled-up street monsters far away from the band. Claiming to know Jetblack gets the team nothing but ridicule. ("You talked to

## AID FROM THE VAMPIRE

Jetblack? Yeah, sure, chummer. He was playing poker with Elvis, Jim Morrison, and Adam Vikk, right?") Sorry, chummers. Dead end.

The team will have better luck contacting Wallace for support. Getting word to Wallace requires an Etiquette (Street) or (Law Enforcement) (6) Test, and the runners need a fragging good line to hand him. Pitching the idea to Wallace as a "non-attributable raid with plausible deniability," or similar language, gives them the best chance of success. Wallace wants to see Teague go down, and is willing to invest a little effort to make it happen. If the gamemaster decides the team talks Wallace into it, Wallace connects them with four low-grade street ops who have no traceable relationship to Wallace or the FBI. (Use the Ork Mercenary Archetype, **SR**, p. 41 or

**SRIIGM**, p.10.) The team is not responsible for paying the mercs' per diem, but they expect a share of any loot from the raid. Granted, the runners plus four rough-and-ready orks makes a puny assault team, but it beats the runners going solo.

The might consider another option: cut and run, drop out of sight, and hope nobody geeks them. Not a heroic choice, nor a particularly smart one. Trying to stay one jump ahead of a good percentage of the shadows makes for a short, tense life.

If the runners try contacting The Shadows, hiring their own muscle, or contacting Wallace, send them and their team to **Final Assault**. If the team goes with Jetblack to meet the band, go to **Final Assault**, taking Jetblack and twenty Nightstalkers as support.



# SHADOWS IN THE SHADOWS

## TELL IT TO THEM STRAIGHT

So here's where The Shadows hang, huh? A ground-floor condo in the Richmond Highlands, a security guard in a bulletproof glass booth at the lobby door and no obvious alarm systems. Wouldn't take much effort break in here.

But it seems you won't have to. With a quiet, "Wait here," Jetblack leaves you by the vehicles and janders up to the guard. Whatever the ganger says does the trick. The guard opens the front door; Jetblack signals you to come inside. Two of the Nightstalkers escort you as you enter the building.

Approaching the condo owned by The Shadows' friend, Jetblack looks nervous. He hesitates at the door, afraid to knock.

Before he can work up his courage, the door opens. An attractive, dark-haired woman—Maril Bremerton, lead singer of The Shadows—stands in the doorway. She looks Jetblack up and down for a moment, and then a warm smile lights up her face.

"It is you," she murmurs. "I *knew* you weren't dead." She throws an arm around the hesitant vampire, ushering him into the condo, where the other Shadows wait. You watch, a little embarrassed, as the other musicians greet their old friend with hugs and warm handshakes. For a moment you think Jetblack has tears in his eyes...but it must be reaction to the bright inside lighting.



**After the emotional reunion between Jetblack and the band, read the following:**

Maril Bremerton approaches you, her face serious. "Jetblack told us what happened to Allenby. We didn't know Teague tried to buy out Caravan; we *sure* don't want to slave for Highstar." She frowns. "But unless we can prove, really *prove*, that Teague killed Allenby or had him killed, we can't do much. Likely the only proof lies with Teague, maybe somewhere in his house." She shrugs. "I'm sorry. I don't know how we can help you."

Jetblack joins your group. He seems much more relaxed, more focused. It takes you a few seconds to figure out the difference, but then you realize that for the first time since you met him, the vampire looks happy. "They can't help you," he says, referring to the band, "but we can." He glances to the two Nightstalkers who escorted you in. "Right, boys?"

**If the team asks Jetblack his plan for raiding Teague's place, read the following:**

Jetblack shrugs. "We're gangers, not assault troops. You do the planning." He grins. "We follow plans real well if they make sense."

## BEHIND THE SCENES

If necessary, use the Large Residence Archetype, from *Sprawl Sites*, p. 34, for a map of the condo.

The scene between Jetblack and The Shadows can be emotional. The band knew about Jetblack's vampiric condition almost from the start, but respected his decision to drop out of sight. If the gamemaster wants to handle such an emotional scene, and the players might enjoy watching it, feel free to play it out. Otherwise, the band can tell the runners to pour drinks and make themselves at home, while they hold their reunion with Jetblack in another room.

No longer fearing that The Shadows will hate him, Jetblack happily provides the runners with backup. He and 20 of his boys hold themselves at the team's disposal. As Jetblack says, the Nightstalkers are bikers, not assault soldiers; they rarely feel the need to take out fortified enclaves. All planning falls to the runners.

## DEBUGGING

Nothing can go wrong in this set-piece encounter. (If the team goes berserk and guns down The Shadows, or something equally unexpected, the consequences of their lunacy means they can no longer run in the shadows of Seattle.)

Before moving on Teague's place, the team should research his security. Jetblack or one of the Nightstalkers will suggest doing that if the team overlooks it. Refer to *Legwork*, p. 52, to determine what the team can learn about Teague's security.



# THE FINAL ASSAULT

## TELL IT TO THEM STRAIGHT

Vashon Heights, one of the newer luxury enclaves outside the sprawl, lies before you. Vashon Island is an elite residence, its rolling hills and real trees surrounding the individual houses and compounds built for Seattle's rich industrialists.

Teague has a waterfront lot, overlooking Puget Sound. From your vantage point, you can see the compound lies only a kilometer away from the high-speed hydroplane-ferry terminal. It docks here after its run from just south of Lincoln Park on the mainland.

Teague's compound covers almost three hectares of well-manicured grounds, with little copses of trees, and two small ponds probably filled with rare and expensive Japanese *koi*. A six-meter fence surrounds the area. Its top angles outward, likely strung with electrified monowire; the one reinforced gate, at the south side of the

compound, can probably stop anything up to a Citymaster. A small guard shack stands next to the gate. Three guards patrol nearby, with another two probably sitting inside the shack. Other guards patrol the grounds, in twos and threes. You've counted ten so far; there must be more you haven't seen yet. Two troll animal handlers walk large dogs (at least, they *look* like dogs) on heavy leashes. Paranormal animals? You can't tell from this distance, but you wouldn't discount the possibility. There could be more of those, too.

The lawn behind the house extends right down to the water, ending in a low retaining wall about two meters high. A narrow strand of beach, less than two meters wide, runs to the cold edge of Puget Sound. Four more guards lurk down there, obviously not enough to defend almost 100 meters of waterfront, which makes you believe Teague has other defenses, probably motion detectors backed by lasers. This run just goes from bad to worse.

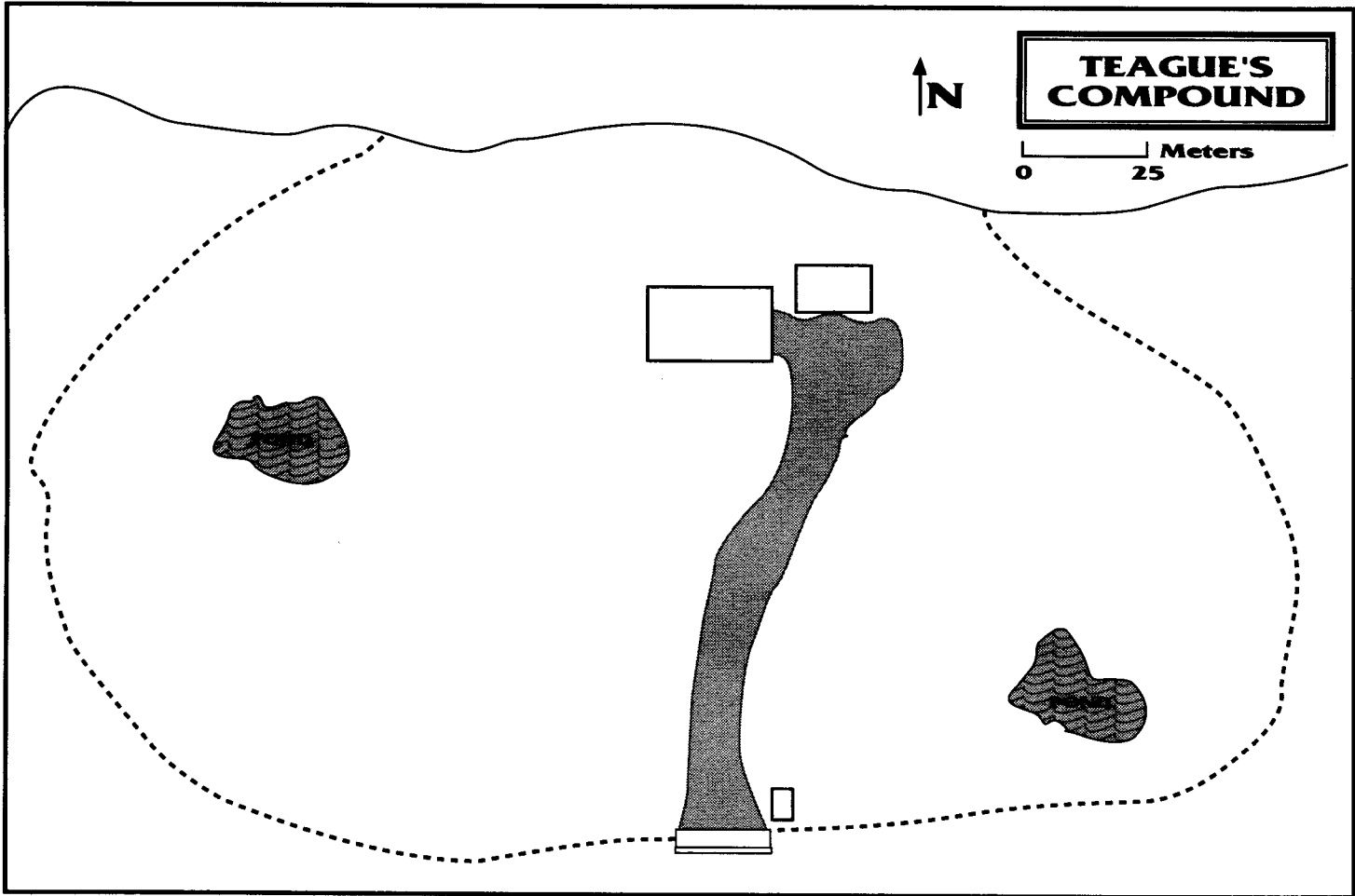

## BEHIND THE SCENES

Teague's compound has a radius of approximately 100 meters.

The team must decide exactly how to handle the break-in. Depending on previous encounters, the runners might be alone, accompanied by muscle hired from the shadows, escorted by Wallace's toughs, or backed by Jetblack and twenty Nightstalkers. A frontal assault on the compound constitutes a messy form of suicide. The guards cannot hold off a determined attack forever, but they really only need to slow the attackers and call for back-up (see **Back-up**).

### PHYSICAL SECURITY/GROUNDS

The reinforced, chain-link fence and gate provide Barrier Rating 24 against vehicles and a Barrier Rating of 8 against a sharper instrument. Obviously, this Barrier Rating does not apply to bullets. If the runners go over the fence, the gamemaster decides whether or not the runners touch one of the top three monowire strands. If a runner touches one of the wires, use the following Damage Codes. Grabbing a wire results in 4S4 damage (SR11, 6S). Hitting it with any force up to a walking speed causes (Body)S4 damage (SR11 (Body x 1.5)S), where (Body) is the character's Body striking the wire. If the character hits the wire at greater than walking speed, he or she takes (Body x 2)S4 (SR11, (Body x 3)S) damage.

The concrete retaining wall along the shoreline conceals Rating 8 motion detectors facing outward toward the water, with a range of 10 meters. Have the players roll opposed Stealth Tests. Detectors picking up any unexpected motion sound an alarm; and eight armed security guards converge on the area in 5 Combat Turns.

### Security Personnel

Twenty-five Hard Corps security guards protect Teague's home: three work from the shack by the front gate, twelve patrol the property, five cover the waterfront, and another five deploy unseen around the house. Two troll animal handlers also walk a beat, each with a large attack dog on a leash. A third troll and dog cover the house and are hidden from view. (Not paranormal creatures. Lucky, aintcha, chummer?)

### Hard Corps Security Guard (25+)

Not particularly bright, but good at what they do. Teague pays them to kill intruders, but not get killed. Risks come with the job, but they willingly give up a bad position to survive.

<b>B</b>	<b>Q</b>	<b>S</b>	<b>C</b>	<b>I</b>	<b>W</b>	<b>E</b>	<b>M</b>	<b>R</b>	<b>Armor</b>
5	6	4	1	2	5	6	—	4	6/4

**Initiative:** 4 + 1D6

**Dice Pools:** Defense (Armed) 4, Defense (Unarmed) 4, Dodge 6  
(Threat/Professional Rating: 3/3)

**Skills:** Armed Combat 4, Etiquette (Corporate) 3, Etiquette (Street) 2, Firearms 5, Unarmed Combat 4

**Gear:** AK-97 [Assault Rifle, 38 (clip) (SA/BF/FA), 5M3 (8M), w/Laser Sight, recoil compensation (2), and 3 extra clips] Microtransceiver, Partial Heavy Armor (6/4), Survival Knife (4L3 (6L))

### Animal Handler (3)

Almost as mean as the beasts they handle, the handlers prefer to avoid toe-to-toe scraps with really tough opponents. Instead, they

loose the dogs, then hunker down behind cover and take pot-shots at anything the animals leave standing.

<b>B</b>	<b>Q</b>	<b>S</b>	<b>C</b>	<b>I</b>	<b>W</b>	<b>E</b>	<b>M</b>	<b>R</b>	<b>Armor</b>
7	4	6	1	2	4	6	—	3	6/4

**Initiative:** 3 + 1D6

**Dice Pools:** Defense (Armed) 3, Defense (Unarmed) 4, Dodge 3  
(Threat/Professional Rating: 2/2)

**Skills:** Armed Combat 3, Etiquette (Corporate) 2, Etiquette (Street) 1, Firearms 4, Unarmed Combat 4

**Gear:** AK-97 SMG [SMG, 38 (clip (SA/BF/FA), 4M3 (8M), w/Laser Sight, 1 extra clip], Microtransceiver, Partial Heavy Armor (6/4), Survival Knife (6L3 (8L))

### Dog (3)

<b>B</b>	<b>Q</b>	<b>S</b>	<b>C</b>	<b>I</b>	<b>W</b>	<b>E</b>	<b>R</b>	<b>Attacks</b>
3	4 x 4	3	—	2/4	2	6	4	4M2 (6M)

**Initiative:** 4 + 1D6

**Attack Dice:** 4

(Threat Rating: 3)

### MAGICAL SECURITY

When the team makes its run, they face no on-site mage (lucky, lucky), but a Rating 4 earth elemental protects the house from attackers.

### BACK-UP

The first support team, a rigger piloting a Yellowjacket armed with a Vanquisher minigun, arrives ten minutes after the first call for back-up. Five minutes after that, the main support force shows up: a rigger-flown Hughes WK-2 Stallion with Improved armor, carrying seven Hard Corps security guards, and a Citymaster, carrying another twelve Hard Corps guards, one of whom drives the vehicle. (Clearly, the runners should scam before the heavy security pours in.)

### Northrop PRC-44B Yellowjacket

<b>Handling</b>	<b>Speed</b>	<b>B/A</b>	<b>Sig</b>	<b>APilot</b>
4	65/130	2/0	3/5	0

**Seating:** Single bucket seat

**Access:** Full canopy

**Sensors:** Security 1 (4)

**ECM/ECCM:** None/Security 1 (1)

**Armament:** Vanquisher Minigun [HMG, 100 (belt), 8S4/4M2 (10S), recoil compensation (3)]. Recoil modifier is 1 per round.

### Hughes WK-2 Stallion

<b>Handling</b>	<b>Speed</b>	<b>B/A</b>	<b>Sig</b>	<b>APilot</b>
5	170/250	5/1 (3)	4	3

**Seating:** Twin bucket seats + 6 folding benches

**Access:** 2 standard + 1 double-sized

**Sensors:** None

**ECM/ECCM:** None

**Armament:** Vanquisher Minigun [HMG, 100 (belt), 8S4/4M2 (10S) mounted in rear cabin door]. Recoil modifier is 1 per round.

### Citymaster

<b>Handling</b>	<b>Speed</b>	<b>B/A</b>	<b>Sig</b>	<b>APilot</b>
4/10	30/120	4/4 (12)	2	3

**Seating:** Twin bucket seats + 10 folding benches

**Access:** 2 standard + 1 rear hatch

**Sensors:** None

**ECM/ECCM:** None

**Armament:** FN-MAG 5 [MMG, 200 (belt), 8S4/4M2(9S) mounted in micro-turret, with laser sight, recoil compensation (2)].

**Riggers (2)**

Dedicated Hard Corps operatives, the riggers keep out of range of small arms, using the minigun to hose down the opposition. Out of their vehicles, the riggers lose their combat edge, so they land only if circumstances force them to.

**B Q S C I W E M R Armor**  
4 6 3 2 5 4 4.5 — 5 (7) 5/3

**Initiative:** 5 (7\*) + 1D6 (2D6\*) (\*when rigging only)

**Dice Pools:** Defense (Armed) 1, Defense (Unarmed) 1, Dodge 6

**(Threat/Professional Rating: 3/2)**

**Skills:** Computer 5, Electronics 5, Etiquette (Corporate) 4, Etiquette (Street) 2, Firearms 3, Gunnery 3, Rotor Craft 4 (Fixed-Rotor 6)

**Cyberware:** Low-Light Cybereyes, w/Thermographic and Flare Compensation, Datajack, Vehicle Control Rig (1)

**Gear:** Armor Jacket (5/3), Fichetti Security 500 [Light Pistol, 10 (clip) (SA), 3M2 (6L), w/Laser Sight]

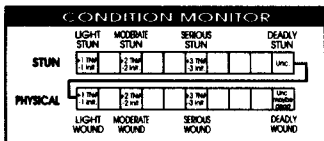

**Animal Handler 1**

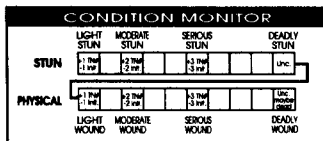

**Animal Handler 2**

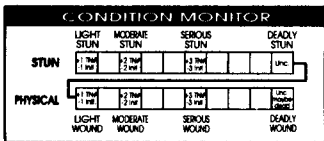

**Animal Handler 3**

**Northrop PRC-44B Yellowjacket**

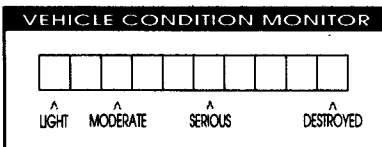

**Hughes WK-2 Stallion**

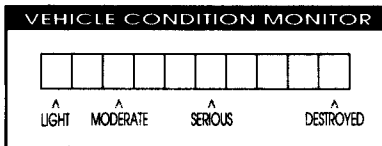

**Clymaster**

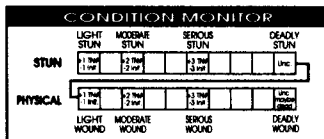
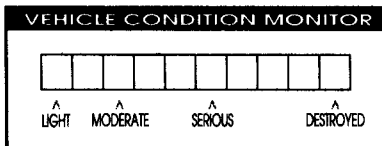

**Rigger 1**

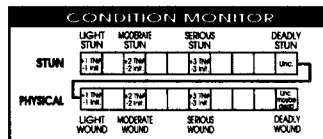

**Rigger 2**

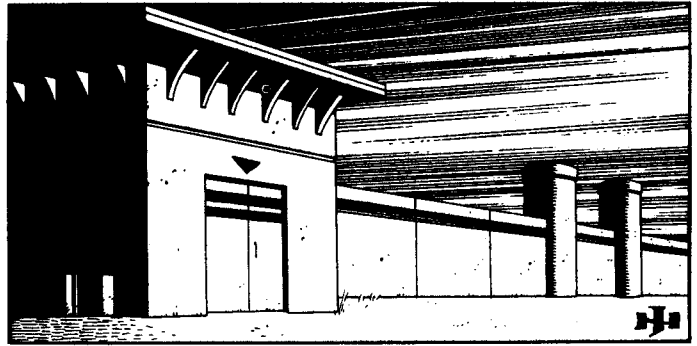

**SECURITY SHACK**

Constructed of thick ballistic composite, the security shack provides Barrier Rating 14 hard cover to anyone inside. A Rating 6 maglock secures the door from inside. The shack's computer terminal connects to the central computer that runs Teague's security systems. A decker who jacks into this system and defeats its security stands a good chance of deactivating some of Teague's less pleasant surprises.

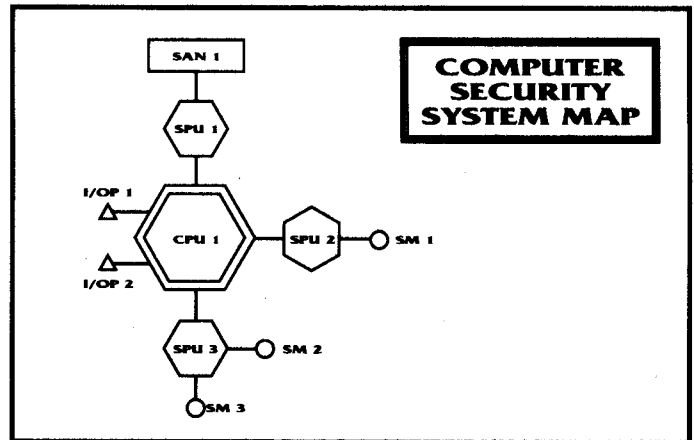

**Security Computer System Map**

**CPU-1:** Orange-4, Barrier 4, Blaster 4. Controls the entire system.

**SPU-1:** Orange-2, Barrier 3. Manages communication between the CPU and SAN-1.

**SPU-2:** Orange-4, Barrier 3. Dedicated to handling the motion detectors along the seawall.

**SPU-3:** Orange-4, Barrier 3, Blaster 3. Dedicated to handling the lasers and the pressure pads in the house (see below).

**SAN-1:** Orange-4, Barrier 3. A "dial-out-only" node, meaning access to the Matrix can be initiated *only* by the CPU. If the system goes on active alert, this SAN calls the Hard Corps headquarters for back-up, even if the guards fail to make the a call.

**I/OP-1:** Orange-4, Barrier 4, Blaster 3. The terminal in the security shack.

**I/OP-2:** Orange-4, Barrier 3. A terminal in Teague's study.

**SM-1:** Orange-4, Barrier 4, Blaster 2. The motion detector system along the seawall.

**SM-2:** Orange-4, Barrier 4, Blaster 2. The two-phase laser system protecting the house perimeter.

**SM-3:** Orange-4, Barrier 4, Blaster 2. The pressure-pad system in the main hallways of the house.

# THE FINAL ASSAULT

## TEAGUE'S HOUSE

The concrete exterior walls provide Barrier Rating 16 protection, while the exterior doors, built of thick ballistic composite, provide Barrier Rating 14 protection. Interior walls are thick construction plastic with Barrier Rating 10, and interior doors are thin construction plastic with Barrier Rating 4. The reinforced windows, with Barrier Rating 4, lock physically, not electronically, from inside. The same two-stage laser system that protects the exterior doors covers the windows.

### Front Hallway (1)

This door stays locked at all times, secured with Rating 5 maglock. A two-stage laser system protects the doorway, and a pressure-triggered sensor lies just inside the door under the carpet that will trigger an alarm if subjected to more than 40 kg of pressure.

### Guest Room (2)

Currently, Meta's room. Her clothes hang in the closet, and the bed looks slept in.

### Guest Bathroom (3)

Used by overnight and other guests.

### Trideo Room (4)

A sophisticated, staggeringly expensive entertainment suite dominates one whole wall.

### Meeting Room (5)

Though Teague considers this house his private hideaway, he occasionally schedules meetings here. A large boardroom-style table fills this room, with comfortable chairs arrayed around it.

### Library (6)

Overstuffed bookcases line the walls on all sides.

### Guest Room (7)

A smaller guest bedroom, currently unoccupied.

### Teague's Bathroom (8)

The epitome of luxury, this bathroom has all the modern conveniences of a sybarite's wish list, including a huge, sunken jacuzzi.

### Kitchen (9)

Predictably, Teague's kitchen features every labor-saving device known to (meta)humanity. If the runners come through here, Teague's cook tries to hide under the sink. (Use the Pedestrian Archetype from *Sprawl Sites*, p. 116 or *SRIGM*, p. 25.) Though unnamed, if the cook thinks her life is truly in danger, she snatches up a butcher knife (1L1 {1L}) to defend herself, though she cannot do much harm with it.

### Teague's Den (10)

At the slightest hint of trouble—an alarm going off, the sound of gunfire, and so on—Teague and Meta retreat to this room for safety. Its thick ballistic composite walls provide heavy cover, Barrier Rating 14, and the standard ballistic composite door provides heavy cover with Barrier Rating 8. A desk terminal connected to the security computer is concealed behind a panel in one wall. A portable, notebook-sized computer next to the terminal holds Teague's personal files, protected by password security equivalent to Barrier 2. Consider the notebook to have a Green-2 security code. If a decker has the right interface hardware, he or she can try jacking

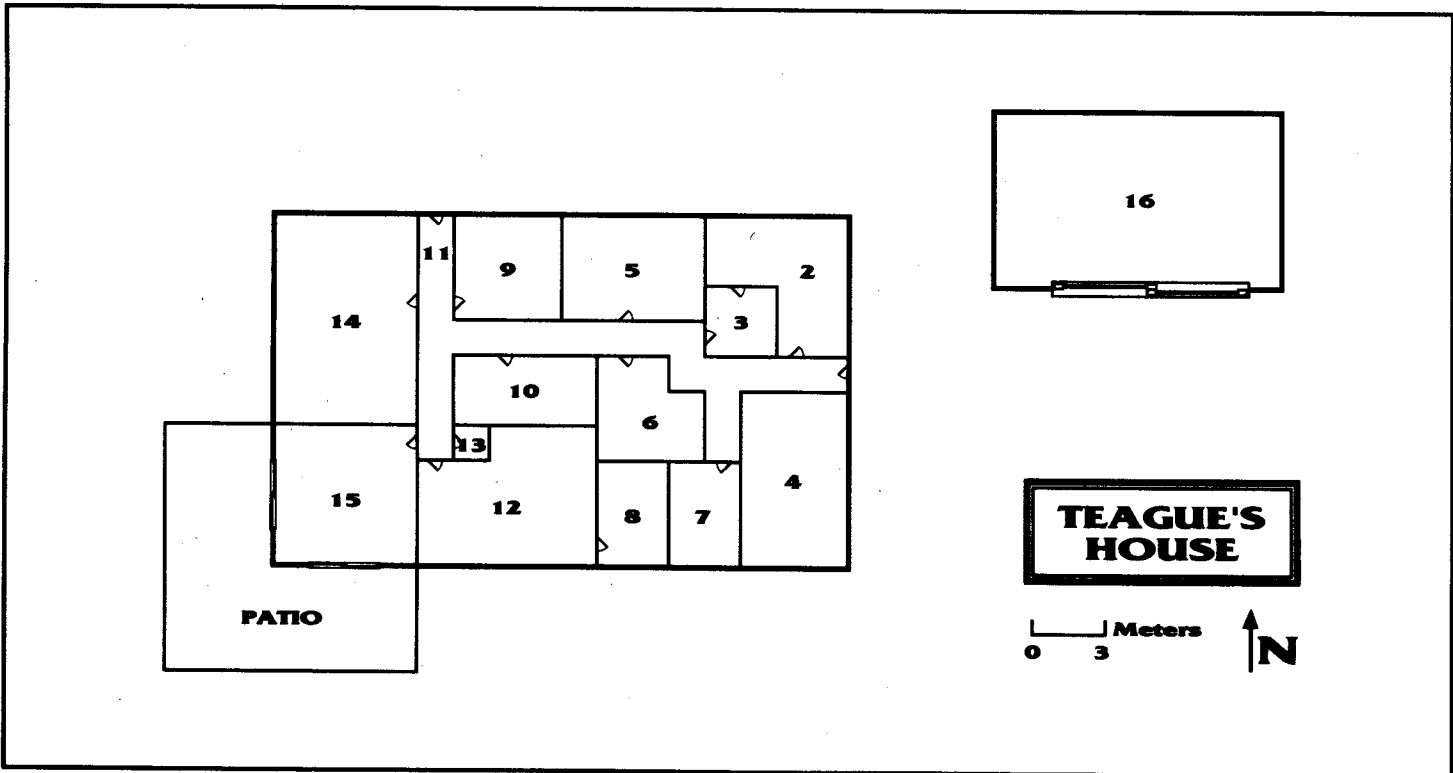

into these files. Lacking the right equipment, the decker must use the keyboard (thus becoming a tortoise). Teague's files contain extensive data concerning Teague's attempts to take over Caravan, plus Himmem's notes for installing the booby-trapped simsense on Allenby's computer. In other words, these files prove Teague hired Allenby's murderer. Teague and Meta will fight to the death to drive off any runners who make it this far.

**Rear Hallway (11)**

The door remains locked at all times, secured with a Rating 5 maglock. A two-stage laser system protects the doorway, and just inside the door under the carpet lies a pressure sensor that will trigger an alarm if pressure of more than 40 kg is applied to it.

**Teague's Bedroom (12)**

This room is decadent beyond imagining. Most denizens of the shadows have never seen such sybaritic splendor. Looters can lift costly gewgaws worth a total of several thousand nuyen.

**Storage Closet (13)**

This closet contains Teague's sporting equipment.

**Dining Room (14)**

Large and opulent enough to fit in a luxury hotel, the runners may also be able to lift "cash prizes" from this room.

**Living Room (15)**

Another room furnished to show off Teague's money, with another built-in high-tech entertainment suite. The sliding doors onto the patio can be electronically polarized, their degree of opacity or transparency controlled from small dials on the walls. The sliding doors lock mechanically from inside, and have no outside keyholes. Of reinforced glass, they provide Barrier Rating 8. The two-stage laser system on the front and back doors also protects the patio doors. Pressure pads just inside the doors will sound an alarm under more than 40 kilograms of pressure.

**Garage (16)**

The heated garage contains Teague's personal car, a SAAB Dynamit 776TI, and Meta's BMW Blitzten (see *It's My Party*, p. 27).

**SAAB Dynamit**

Handling	Speed	B/A	Sig	APilot
4/8	80/250	2/1 (3)	1	3

**Seating:** Twin bucket seats + bench

**Access:** 2 standard/open top

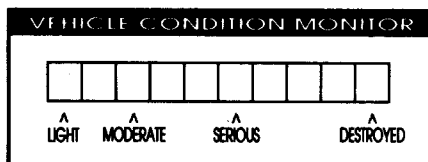

**SAAB Dynamit**

**GETTING IN**

Though formidable, Teague's defenses can be cracked. A clever team might walk in after fast-talking the guards at the gate. If the team's decker can access the computer terminal in the guard shack, he or she can shut down most of the security systems in the house.

A team using the direct approach should have the Nightstalkers or the hired street muscle stage a diversionary attack, perhaps at the gate. This will keep the guards busy while the team sneaks onto the property elsewhere, perhaps along the fence or from the water (using Suzuki Watersports or other low-draught vessels to get close enough, assuming they can lay hands on some). Unless the decker can compromise the security system by this time, the motion detectors pick them up, but fewer guards respond to the alarm. Whatever plan the runners use, they must get in and out fast, before the Hard Corps back-up arrives. When the cavalry shows up, the team had better be packing heavy enough weapons to take out both the rotorcraft and the Citymaster, or they are dead meat.

**GAMEMASTER'S NOTE**

If the Nightstalkers join the runners in their assault, some fifty guys with guns will be running around, plus three dogs and a slotted-off Earth elemental. If the Hard Corps back-up comes out to play, the number of pistol-packers goes up to almost seventy. Does this situation give the gamemaster too much to handle, and threaten to slow things down?

Not necessarily. The last encounter of the adventure should provide an almost cinematic climax. Logically, the runners will keep their actual assault team small, using most of the Nightstalkers to provide a diversion. Most of Teague's guards join in the main action against the twenty gangers, keeping the number of foes battling the runners manageably low. Because the diversion takes place "off-stage," the gamemaster need not play it out in detail. The runners only hear sounds of distant mayhem.

Even if the team surrounds itself with Nightstalkers for the assault, the entire combat with its many dice rolls need not be played out. The scenario should produce fast-and-loose, exciting combat. Only those shots aimed directly at the runners, or fired by them, need be rolled. Treating all other occurrences around the runners as background gives the gamemaster unprecedented flexibility in tailoring the opposition to match the team's capabilities. Are the runners in trouble, about to be geeked? Have a roving squad of Nightstalkers appear to rescue them. Are the runners romping and stomping all over the Hard Corps heavies? Let a platoon of guards recognize the diversion for what it is, and charge the house in time to block the runners' break-in attempt.

The gamemaster should allow this scenario to provide the players plenty of fun and opportunities to blow things up. It should not be used to prove to the players how tough the gamemaster can be, nor should the action bog down with fifteen kabillion dice rolls. Keeping this in mind, the gamemaster can make the final confrontation the kind of fun-filled apocalypse any shadowrunner will enjoy.

**DEBUGGING**

If the runners fail in this final scene, they have failed to accomplish their goal, and can do nothing about it. (They may even be dead.) Whatever the outcome, go to *Picking Up the Pieces*, p. 46.

# PICKING UP THE PIECES

## IF THE TEAM SUCCEEDS

If the team pulls off the final assault, they possess unassailable proof that Teague ordered Allenby killed, and can use the evidence in Teague's computer files to clear themselves. They may even feel cocky enough to present this evidence to Lone Star in person. However, as the cops still consider the runners "armed and dangerous" murderers, coming too near their headquarters entails serious risk. If the runners stay alive long enough to get the evidence to a senior Lone Star official, he or she will recall the warrants for their arrest. Of course, Lone Star will admit to no wrongdoing in having issued the warrants. The team will get neither apology nor restitution. No official, particularly a law enforcement professional, likes being proven wrong, especially by the target of the error. The team earns no brownie points with the Star. Quite the opposite, in fact.

A more low-profile team transmits the proof to Lone Star via other channels. Again, the Star recalls the warrants without apology or restitution.

Obviously, Teague as Mr. Johnson will not pay the runners. Because this adventure turned into one big expense, they might decide to try turning their dirt on Teague into some nuyen. For instance, they might approach Highstar's senior management, or even Mitsuhamma, the parent company, and try to extort money from them by threatening to publicize evidence of murderous corporate intent. Unfortunately, this tactic gains them nothing. No formal link exists between Teague's actions and the will of the corporations involved; the corps can simply declare Allenby's murder the isolated act of a deranged renegade. Highstar and Mitsuhamma may mount a major smear campaign against Teague, painting him as a "loose cannon" whose criminal actions risked bringing the whole corporate system into disrepute. While sheltering themselves behind "plausible deniability," the corps hire hit teams to silence the runners. The team loses out on two fronts; no corp money, and a constant struggle to stay alive as long as they remain in Seattle. Not a good way to promote a career. A generous gamemaster can have each player make an Etiquette (Corporate) (4) Test to recognize the disastrous results of any attempt to blackmail the corps. (Did the corporations know what Teague was doing? An interesting question, chummer, but it can't be proved one way or the other.)

A slick team might squeeze some money from Highstar or Mitsuhamma by offering the proof of Teague's nefarious activities to the corps as a "public service," saying, "We thought you should know about this potentially damaging blow to your corporate prestige," or some similar drek. In return, the runners could receive a minor "retainer," say 20,000¥, from the corporation for bringing this shocking matter to their attention.

And what about Teague? Assuming he managed to live through the raid on his home and escape somehow, he counts his lifespan in days. Teague's continued existence threatens the corps' plausible deniability, and Highstar and Mitsuhamma dispatch hit teams to silence Teague before he can claim corporate backing of his actions. Within 48 hours, word will hit the streets that Teague committed suicide in shame over the scandal.

As for Himem the decker, he is alive and well and living in Seattle. Somewhere. Even if the team decker bested him in a dogfight, he or she only dumped Himem from the system. Himem's meat body still exists out there, unharmed and burning with shame from his defeat at the hands of a virtual nobody in the Matrix. At the gamemaster's discretion, Himem can plot his revenge against the team, appearing in the future to harass them at an inopportune time.

Wallace drops completely out of sight, except perhaps for a cryptic note of congratulations. Wallace keeps the team's names on file, and may approach them if he needs another shadowrun in Seattle. Wallace makes an excellent Mr. Johnson for future adventures.

## JETBLACK AND THE SHADOWS

What about the "dead" musician and the megastars?

If Jetblack dies in the assault on Teague's compound, The Shadows assume that Jetblack threw in his lot with the runners partly to assuage his own guilt over becoming a vampire. They mourn his death, but know it was his own decision.

If he survives, Jetblack returns to his shadowy life, surrounded by the remaining Nightstalkers. Grateful to the runners for bringing him and The Shadows together again, Jetblack serves as an excellent future contact for the team.

Though he intends to keep his continued existence secret from everyone else, Jetblack stays in touch with The Shadows. For old time's sake, he joins in on a private "jam session" with the megastars, the first time, all five will play on one stage. They invite the runners, of course, and even give them a simsense of the event as a memento. The team could sell this bootleg simsense on the open market for thousands of nuyen, but only by betraying the trust of Jetblack and The Shadows. A vampire gang boss makes a bad enemy.

With Teague eliminated, The Shadows band gains "free agent" status and stays out of Highstar's clutches. To show the runners their gratitude, The Shadows pay them 100,000¥ "for services rendered," plus two tickets each to the upcoming Kingdome show. The band makes good future contacts for the runners, and may even send work their way.



## IF THE TEAM FAILS

If the team messes up the assault on Teague's compound, they do not have to worry about their reps, as they will most likely die horribly. Any survivors still face murder charges, and if Teague survived, he sends hit teams to rub them out. Between legal bloodhounds and corporate death squads, the runners can only expect to live a long life if they get the heck out of Seattle, and probably the entire UCAS. The Highstar hitters will not bother following them, but the runners have blown their careers in Seattle forever.

If Teague survives, Highstar can legally absorb Caravan's operations and The Shadows become the unwilling property of the corp.

## KARMA

Award team Karma as follows:

Dumping the decker Himem	1
Finding evidence of Teague's actions in the Highstar system	1
Finding Himem's booby trapped simsense	1
Orchestrating the reunion between Jetblack and The Shadows	3
Defeating Teague alone*	2
Taking actions that lead to his corp eliminating Teague *	1
Finding proof of Teague's skullduggery in his personal computer	3

\*These two outcomes are mutually exclusive.

Award individual Karma Points according to the guidelines on page 160, *Shadowrun*, or page 199, *Shadowrun, Second Edition*.







# LEGWORK

To follow up on or discover clues in this adventure, the player characters need to investigate people, places, and situations. One of the best ways for runners to get the information they need is through their contacts. This section provides success tables containing information available to the runners from their sources.

A success test using Street or Corporate Etiquette, Target Number 4, typically serves to find out what a contact does or does not know. The amount of information available from the contact depends on the number of successes the player achieves. Characters who achieve more than one success gain all the information available to all previous levels of success.

The gamemaster should try to make the player character's interaction with his contact consist of more than a few abstract die rolls. Play out the meeting in full: contacts are characters with their own lives, points of view, and needs, not simply spigots of information to be turned on and off automatically.

The player character rolls a number of dice equal to his Etiquette Skill to determine what information the contact knows and will impart. Once the number of successes is determined, the gamemaster can roleplay the encounter with the appropriate information level in mind. Meetings should be tailored to the "personality" of specific contacts. Some will prefer a straightforward meet in a specific place, while others will only feel comfortable with elaborate forms of information exchange.

Contacts are generally considered trustworthy, as long as the runners play it safe. A player character should never compromise his contact by later tipping others to his source, or by revealing that the team may be planning to hit some group with which the contact has connections. Are the contact's ties stronger to his group or to the runner? A good runner never tests those ties by placing his contact in a position where he must choose.

The questions of whether or not the runner has to pay for his contact's services, and how soon the contact may want information or a favor in return, add another dimension to these encounters. Dealing with a contact is a two-way street. Those gamemasters who need a base-line value to determine fees for information can use the following formula. Multiply the contact's Skill Rating in his or her most appropriate Etiquette Skill by the number of successes the player rolled in his Etiquette Test. Multiply that total by the sum of the contact's Charisma and Intelligence. Then multiply that final value by 10. The result is in nuyen. Gamemasters will, of course, adjust the base result to reflect the actual contact involved. Normal Negotiation procedures apply to determine the final payment for the information.

Runners may also ask their contacts to "check around," "keep their ear to the ground," or some other idiom describing generally listening for news. In such a case, the gamemaster makes an appropriate Etiquette Test for the contact at +2 against the target number given in the information table. If the Etiquette Test results

in any successes, the contact reports the appropriate information to the runner in 2D6 hours, or at a time determined by the gamemaster. This is an excellent way for gamemasters to make sure that a certain piece of information makes it to the runners. The cost of this service is determined as if the contact initially had access to the information (see above formula).

The gamemaster can add complexity to legwork by acknowledging that contacts are not always available at the convenience of the runners. Arrangements must be made before the actual meeting can take place. When a player character wants to meet with a contact, the gamemaster rolls 2D6, then multiplies the result by 30. The resulting base time is the number of minutes it will take to arrange the meeting with the contact. Players may elect to trade off successes from their Etiquette Test to reduce the time it takes to reach the contact, and so receive faster, but potentially less helpful, information. In this case, the gamemaster can have the player make the character's Etiquette Test at the time he announces his intention to meet with the contact. The player should also decide at that time how many successes he will trade off to reduce the waiting period. The base time value should be kept secret.

## ELECTRONIC LEGWORK

Deckers may also take an active role in acquiring general information. Many electronic information services exist in the era of **Shadowrun**—public, private, and secret—and these contain gigapulses of data comprised of on-line conversations, rumors, stolen and dumped files, and the like. Deckers can create simple programs to search vast databases for key words and related terms, then download the information to their cyberdeck or Matrix-connected personal computer. Creating the search program is a trivial matter; gamemasters should assume all deckers have one.

Virtually any information available in this section can be found in the Matrix, if one knows where to look and has the time. The base time for such a search is 2D6 hours. The decker makes a success test against his or her Etiquette (Matrix) Skill, or defaults to Intelligence on the Skill Web. The target number is the same as given on the information table. Hacking Pool dice may not be used to supplement this success test roll. Etiquette Test successes can be traded off to reduce the base time for receiving information. Appropriate Contact restrictions do not be apply to obtaining information through the Matrix, though the player must indicate what kind of information sources he is searching. If the character is searching corporate-related databases, Corporate Contact information is appropriate. If the character is searching a street-level chat-line database, Street Contact information is appropriate.

A decker is limited in the number of subjects he can research simultaneously, based on his own abilities and the available time. The

maximum number of searches that the decker can conduct at any one time is equal to half the character's Intelligence, divided by 2, rounded up. This base value assumes the decker does nothing else but sit and search, continually adjusting the search paths and parameters. If the character wishes to actively perform other activities, the gamemaster must decide how much time is taken up performing those other activities and adjust the base value accordingly.

## HIGHSTAR INCORPORATED

Apparently a major player in the Seattle entertainment scene, Highstar is actually a puppet company with its parent, Mitsuhama, pulling the strings. Highstar wants to increase its control of the music biz in the sprawl.

### Appropriate Contacts (Target Number 4)

Any Street or Corporate Contact. For a Contact associated with the media or the entertainment biz, use Target Number 3.

Successes	Result
0	"They make dirigibles, don't they?"
1	"Yeah, a big noise on the entertainment scene. Live shows, trid, that kind of thing."
2	"Trying to increase their profile in the music biz, that's what I hear."
3+	"Highstar? Don't bother looking for drek on Highstar. Dig up the drek on the company that owns Highstar, Mitsuhama."

## CARAVAN

Famous for managing Jetblack before his death, and currently The Shadows, Caravan is an influential company wholly owned by Allenby.

### Appropriate Contacts (Target Number 4)

Any Street or Corporate Contact. For a Contact associated with the media or the entertainment biz, use Target Number 3.

Successes	Result
0	"Null program, cobber."
1	"Oh yeah, they're putting on the big Shadows show at the Kingdome. Think of the nuyen in that..."
2	"Caravan's prez is a scuzzy little dwarf called Allenby. Wotta drekhead..."
3	"Caravan used to manage Jetblack, too, before he kicked off."
4+	"I don't know if I believe it, but I've heard some buzz that somebody's trying to take over Caravan."

## ALLENBY

The president and sole shareholder of Caravan Productions, Lew Allenby is a big noise on Seattle's music scene. He has a reputation as a phenomenal businessman, and an unbelievable jerk. Only his knack for turning deals into gold makes people put up with him.

### Appropriate Contacts (Target Number 5)

Any Street or Corporate Contact. For a Contact associated with the media or the entertainment biz, use Target Number 3.

Successes	Result
0	"Doesn't ring any bells, chummer."
1	"Allenby? Oh yeah, the drekhead dwarf. Prez of Caravan. He manages The Shadows."
2-3	"Managed Jetblack, too, before he died. Good rep in the biz. Everything he touches turns to gold."
4+	"I hear somebody's making a move on Caravan, but Allenby's going to stop 'em stone dead, like he did every other take-over bid."

## TEAGUE

Highstar Incorporated's executive vice-president, Teague holds considerably higher rank than the "junior expediter" he styles himself when approaching the runners. A Machiavellian manipulator, Teague plans to accomplish great things...unless the runners toss a wrench into the works.

### Appropriate Contacts (Target Number 5)

Any Street or Corporate Contact. For a Contact associated with the media or the entertainment biz, use Target Number 4.

Successes	Result
0	"Sounds like a Johnson to me, but I don't know 'Im."
1-2	"Oh, yeah, he works for Highstar. Real corporate warrior, good at climbing the ladder. An up-and-comer."
3	"Hot guy, exec Veep, I think. Buzz on the street says he's making a move on the prez. But what Veep isn't?"
4+	"Got some kind of deal going with Caravan, that's the way I hear it."

## META

Teague's expediter, and one-time shadowrunner. A lethal street operator.

**Appropriate Contacts (Target Number 4)**  
Any Street Contact.

Successes	Result
0	"Who?"
1	"Meta? Yeah, that rings bells. Used to be a drek-hot shadowrunner. Dropped out of sight about three years back. Dead, maybe?"
2	"No, I remember now, she sold out. Started working for some corp."
3	"Highstar, that's the corp."
4+	"She works for this slag called Teague. 'Personal expediter,' she calls herself. Hatchetwoman, more like."

## THE SHADOWS

The hottest band on the circuit at the moment. Everybody knows The Shadows.

**Appropriate Contacts (Target Number 4)**  
Any Street or Corporate Contact. For a Contact associated with the media or the entertainment biz, use Target Number 3.

Successes	Result
0	"The Shadows? Sure, they're playing the Kingdome in a couple of weeks. I'd kill for tickets."
1	"Hottest thing to hit the music scene since Jetblack bought it. Maril Bremerton up front, Joey Nightmare on synth-axe, and Sid Id and Erle Hawkins on synths. They're mega-hot, chummer."
2-3	"They're managed by Caravan at the moment."
4+	"Street buzz says somebody's trying to poach them away from Caravan. Good luck. Allenby would rather chew off his arm than let them go."

## JETBLACK

Jetblack is something of a 21st-century Elvis. He burst onto the scene about seven years ago, and personally started the "angst-rock" movement. Neurotics and manic-depressives love his music. About two years ago, he disappeared, apparently killed in random street violence. As happened with Elvis, however, many believe Jetblack still lives, and that he went underground for his own reasons.

**Appropriate Contacts (Target Number 4)**  
Any Contact will do the job. If the Contact is a music aficionado, use Target Number 3. If the runners ask Tangent, use Target Number 3, and give the team 1 automatic success.

Successes	Result
0	"Never heard of him."
1	"Oh, yeah, Jetblack. Hot rocker a few years back. Dropped off the charts, though."
2	"Kinda hard to keep recording when you're dead, chummer."
3	"Officially, he's dead. But lots of people think he's still alive and living underground somewhere. Jetblack Lives is spraypainted on buildings all over town."
4+	"I know it sounds twisted, but the Jetblack Lives types might be right. Lone Star says they found his body, but it was trashed pretty bad. Who knows? Maybe Jetblack does live."

## WALLACE AND THE FBI

A chromed killing machine, Darryl Wallace served with distinction in Desert Wars. Since resigning his commission, he has performed intermittent services for the Federal Bureau of Investigation. Not officially on the Feds' payroll, Wallace helps them out on a contract basis. (In other words, he is a shadowrunner the Feds hire from time to time.) This makes his FBI connections very difficult to dig up.

Before enlisting in the army, Wallace played in a band in New York, attaining considerable success in the entertainment business. This experience makes him particularly useful to the FBI on his current assignment: investigating Lew Allenby, president of Caravan Productions. The Feds have heard recurring (though false) rumors linking Allenby to some kind of financial corruption similar to the "payola" scams of the previous century. The runners attracted Wallace's attention because he saw them leaving Allenby's office and wondered what a respectable promoter wanted with street drek like them.

**Appropriate Contacts (Target Number 8)**

Any Contact. If the Contact has connections with the FBI or the UCAS government, use Target Number 6.

<b>Successes</b>	<b>Result</b>
0-1	"Who? Dunno..."
2	"You're talkin' about 'Ripper' Wallace, ain'tcha? Darryl Wallace, ex-Special Forces, Desert War veteran. Death on two legs."
3	"Yeah, but he resigned his commission awhile back. He's a civilian now. Don't know what he's up to."
4	"Heard he's looking for work. Did some kind of contract drek awhile ago..."
5+	"...For the fragging FBI. Don't ask me what, I don't wanna know. And I don't wanna ever face Wallace when he's ticked-off again."

**THE NIGHTSTALKERS**

One of the lower-profile go-gangs on the streets of Seattle, the Nightstalkers cause a lot less mayhem than their more famous brethren, the Rusted Stilettoes and Crimson Crush. Their leader never shows his face around town, leading some to think he is hiding a big, dirty secret. The Nightstalkers frequently provide security for The Shadows, though no one can figure out the connection between a megastar band and a scuzzy biker gang.

**Appropriate Contacts (Target Number 5)**

Any Street Contact. If the Contact is a gang member, use Target Number 4.

<b>Successes</b>	<b>Result</b>
0	"Sounds like another fragging go-gang to me, chummer."
1	"Yeah, the Nightstalkers, I heard of them. They hang in Bitter Creek."
2	"Interesting bunch. Nobody knows who leads them. Keeps a <i>real</i> low profile. Makes you wonder what he's hiding, <i>neh</i> ?"
3	"Ya know what? Them gangers, they're sometimes hanging around The Shadows—you know, the band? Working security, or something."
4+	"There's something <i>real</i> queer about them Nightstalkers, chummer. I don't know what it is, but it kinda sets my teeth on edge, ya know?"

**TEAGUE'S VASHON ISLAND HOME**

The team can only research this topic if they get the address from the Highstar system.

**Appropriate Contacts (Target Number 6)**

Any Street or Law Enforcement Contact. If the team has a line into a security company, use Target Number 4.

<b>Successes</b>	<b>Result</b>
0	"Some corp suit's place? What do I look like, Better Homes And fragging Gardens?"
1	"North end of Vashon Island? That's Vashon Heights. <i>Real</i> exclusive, chummer. The slags who live there go in for <i>real</i> security."
2	"Ya know, I think I seen the place you mean. Right on the waterfront, surrounded by a big fragging fence. Lotsa guards."
3	"Yeah, it's on the water. But don't think that's the easy way in. Probably got serious motion detectors covering the shoreline."
4+	"Man, if you're thinking what I <i>think</i> you're thinking, stop thinking it. That Teague suit, Hard Corps does his security. You know Hard Corps? One of the best and toughest in the plex."

**HARD CORPS SECURITY INC.**

The boys and girls at Hard Corps have a solid rep in the city. To many runners, any place protected by Hard Corps might as well be marked "Hands Off!" A smart team will try to dig up background on the type of security Hard Corps installed at Teague's place.

**Appropriate Contacts (Target Number 5)**

Any Street or Law Enforcement Contact. For any character stupid enough to approach a Hard Corps employee directly, use Target Number 6.

<b>Successes</b>	<b>Result</b>
0	"No comment. Who the frag are you, anyway? Hey, come back here..."
1	"Hard Corps, one of the best. Well-trained and well-equipped guards."
2	"Astral and computer security. Pressure pads, motion detectors. They know it all."
3	"...And fragging <i>lasers</i> , man. They installed lasers around the perimeter."
4+	"They've got the best rep for back-up in the plex. Within ten minutes of an alarm going off, you'll be drowning in Hard Corps gunners, helicopter gunships, and Citymasters. Get in and get out before they show, or you're as good as geeked."

# CAST OF SHADOWS

The following non-player characters play principal roles in the story of **One Stage Before**. Because they will likely appear more than once in the course of the adventure, their statistics and descriptions are grouped together here for convenience. The characters are

presented here in order of general importance to the story. Descriptions and statistics for other, minor characters appear in the encounter where they make their appearance.

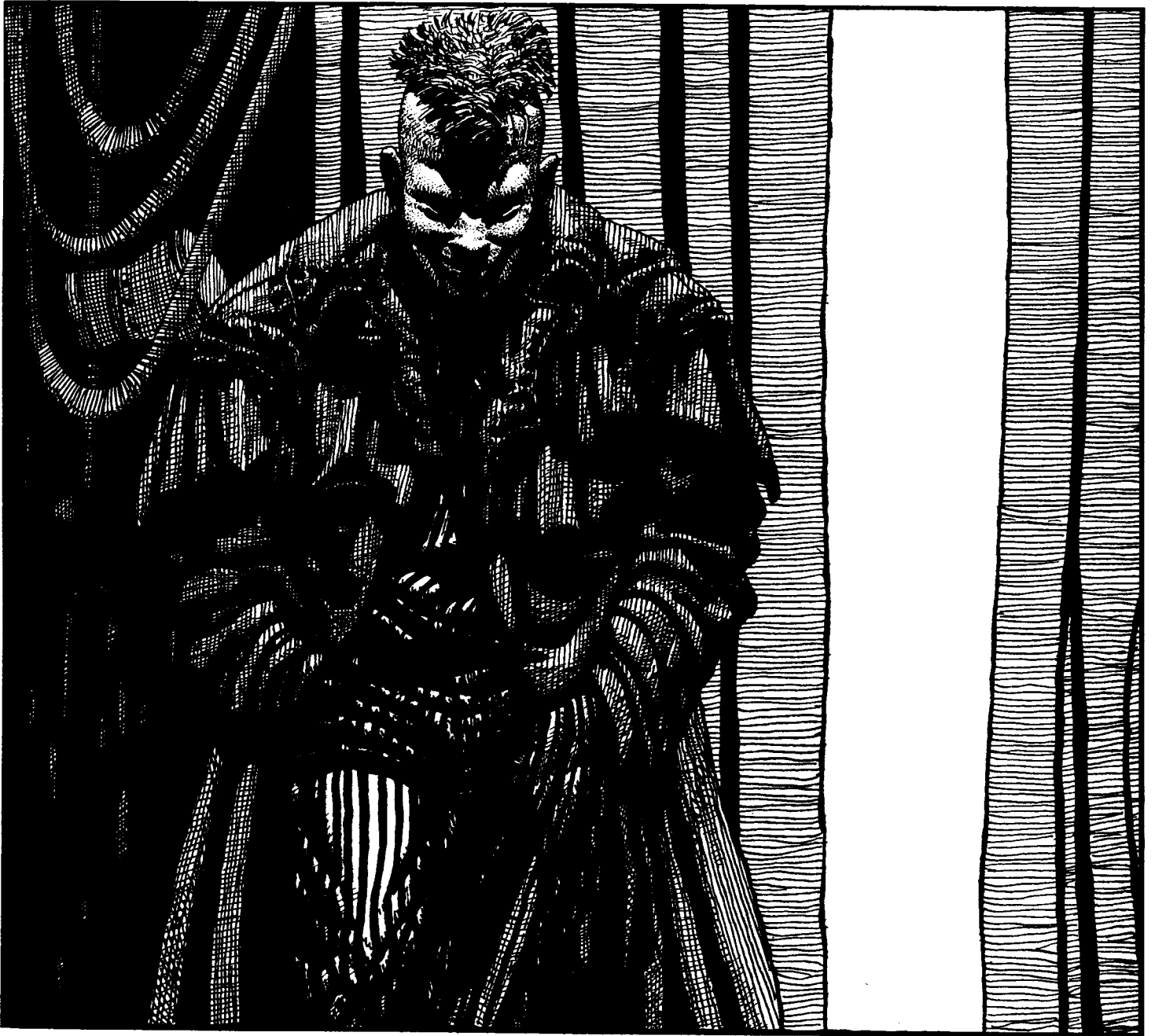

## JONATHON TEAGUE

Born to a rich and influential Seattle family, Jonathon Teague got an early start up the ladder to a high-level corporate career. He received the best education available, and rose to prominence in the sprawl's business community soon after graduation. Coupling a keen business sense with a Machiavellian Instinct for whose back to stab at any given time, he made vice-president before he turned thirty. Five years later, Highstar Incorporated made him executive vice-president. Teague immediately began looking for ways to ease his superior, Takahashi Yanaga, out of the president's suite. Teague quickly realized that he would need to make some major coup for the corp to oust the well-entrenched Yanaga. The skyrocketing success of the band The Shadows attracted the ambitious VP's attention. If he could bring The Shadows into the Highstar stable, Highstar's parent company, Mitsuhama, might reward him with Yanaga's position and power.

Like most corporate execs, Teague maintains extensive connections with street ops and other denizens of the shadows. To guard his own back, he hired a particularly lethal street samurai, a woman called Meta, as his personal expediter.

Teague is a good-looking, hard-faced man who always dresses impeccably. In his left ear he wears a gold stud in the shape of a nuyen sign (¥).

### Attributes

Body: 3  
 Quickness: 5  
 Strength: 3  
 Charisma: 5  
 Intelligence: 6  
 Willpower: 5  
 Essence: 3.8  
 Reaction: 5

Initiative: 5 + 1D6

### Dice Pools

Defense (Armed): 2  
 Defense (Unarmed): 2  
 Dodge: 5

(Threat/Professional Rating: 2/3)

### Cyberware

Datajack with 200 Mp of Memory

### Gear

Ares Viper Silvergun [Heavy Pistol, 30 (clip) (SA/BF), 2M3 (9S) w/Laser Sight]  
 Armor Clothing (3/0)

### Skills

Armed Combat: 2  
 Computer Theory: 5  
 Etiquette (Corporate): 8  
 Etiquette (Street): 5  
 Etiquette (Music Business): 6  
 Firearms: 4  
 Negotiation: 6  
 Psychology: 8  
 Unarmed Combat: 2



CONDITION MONITOR				
	LIGHT STUN	MODERATE STUN	SERIOUS STUN	DEADLY STUN
<b>STUN</b>	+1 TN# -1 Init.	+2 TN# -2 Init.	+3 TN# -3 Init.	Unc.
<b>PHYSICAL</b>	+1 TN# -1 Init.	+2 TN# -2 Init.	+3 TN# -3 Init.	Unc. maybe dead
	LIGHT WOUND	MODERATE WOUND	SERIOUS WOUND	DEADLY WOUND

## LEW ALLENBY

Like many others born on Seattle's meanest streets, Allenby saw only two ways out of poverty: join a gang, or join a band. He chose the latter. Allenby enjoyed a marginally profitable career, making a minor name for himself playing in several bands working in the small underground clubs of the sprawl. Discovering that his business skills exceeded his musical talent, Allenby moved into management. Over twenty years, he built his company, Caravan Productions, into the city's premiere management and production company. Signing Jetblack, and then The Shadows, made Caravan Productions one of the biggest entertainment companies on the entire West Coast.

An irascible dwarf, Allenby is easily angered. Though gifted with considerable interpersonal skills, he frequently chooses not to use them. He is ugly and balding, with a weathered face and cold, flinty eyes.

### Attributes

Body: 4  
 Quickness: 3  
 Strength: 5  
 Charisma: 4  
 Intelligence: 6  
 Willpower: 6  
 Essence: 3.8  
 Reaction: 4

### Skills

Armed Combat: 2  
 Computer Theory: 3  
 Etiquette (Corporate): 6  
 Etiquette (Street): 6  
 Etiquette (Music Business): 8  
 Firearms: 1  
 Negotiation: 5  
 Psychology: 6  
 Unarmed Combat: 2

**Initiative:** 4 + 1D6

### Dice Pools

Defense (Armed): 2  
 Defense (Unarmed): 2  
 Dodge: 3

**[Threat/Professional Rating: 2/3]**

### Cyberware

Datajack with 200 Mp of Memory

### Gear

Armor Clothing (3/0)

		CONDITION MONITOR			
		LIGHT STUN	MODERATE STUN	SERIOUS STUN	DEADLY STUN
<b>STUN</b>	+1 TN#	+2 TN#	+3 TN#		Unc.
	-1 Init.	-2 Init.	-3 Init.		
<b>PHYSICAL</b>	+1 TN#	+2 TN#	+3 TN#		Unc. maybe dead
	-1 Init.	-2 Init.	-3 Init.		
		LIGHT WOUND	MODERATE WOUND	SERIOUS WOUND	DEADLY WOUND



JEREMY RULISIO 1992.

## WALLACE

A big man, chromed to the max, Wallace looks and moves like the trained killer he is. He served several tours of duty with the UCAS army in Desert Wars. Though capable of any necessary act of violence, Wallace prefers to use his intelligence and talk his way out of trouble whenever possible.

As an FBI "contractor," he has significant pull with the Feds, though he rarely uses it.

### Attributes

Body: 6 (7)  
 Quickness: 6  
 Strength: 5 (6)  
 Charisma: 4  
 Intelligence: 5  
 Willpower: 6  
 Essence: .2  
 Reaction: 6 (8)

Initiative: 6 (8) + 2D6

### Dice Pools

Defense (Armed): 5  
 Defense (Unarmed): 3  
 Dodge: 7

[Threat/Professional Rating: 6/4]

### Cyberware

Boosted Reflexes: (3)  
 Cyberlimbs [both arms with Increased Strength, Retractable Spurs, and Implanted Ares Predators [Heavy Pistol, 15 (Internal) (SA), 4M2 (9M)]  
 Cybereyes with Flare Compensation and Thermographic Dermal Plating (1)

### Gear

Lined Coat (4/2)  
 Survival Knife (6L3 (8L))

### Skills

Armed Combat: 6  
 Etiquette (Corporate): 3  
 Etiquette (Street): 4  
 Firearms: 1  
 Firearms (Cyberweapons): 8  
 Specialization: Heavy Pistol 10  
 Negotiation: 2  
 Psychology: 4  
 Stealth: 6  
 Unarmed Combat: 6



### CONDITION MONITOR

	LIGHT STUN	MODERATE STUN	SERIOUS STUN	DEADLY STUN
<b>STUN</b>	+1 TNP -1 Init.	+2 TNP -2 Init.	+3 TNP -3 Init.	Unc.
<b>PHYSICAL</b>	+1 TNP -1 Init.	+2 TNP -2 Init.	+3 TNP -3 Init.	Unc. maybe dead
	LIGHT WOUND	MODERATE WOUND	SERIOUS WOUND	DEADLY WOUND



**META**

Teague's personal expediter, Meta is one of the toughest women on the street. She once held a hot rep as a shadowrunner, but when Teague offered her a steady job that paid more nuyen than she could earn in a lifetime on the street, she took it.

Tall and perfectly groomed, Meta always wears the height of corp *haute couture*. A pair of mirrored wrap-around sunglasses and her skin-tight, silver gloves provide the only discordant details. (The gloves, apparently made of mylar woven with metal, leave no fingerprints and do not interfere with the electrical connection between the smartgun interface pad in her palm and the contacts on her gun butt.

**Attributes**

- Body: 6
- Quickness: 6
- Strength: 5
- Charisma: 4
- Intelligence: 4
- Willpower: 5
- Essence: .2
- Reaction: 5 (11)

**Skills**

- Armed Combat: 5
- Bike: 6
- Etiquette (Corporate): 4
- Etiquette (Street): 4
- Firearms: 6
- Negotiation: 3
- Psychology: 2
- Stealth: 5
- Unarmed Combat: 5

**Initiative:** 5 (11) + 4D6

**Dice Pools**

- Defense (Armed): 5
- Defense (Unarmed): 5
- Dodge: 6

**[Threat/Professional Rating: 6/4]**

**Cyberware**

- Low-Light Cybereyes with Thermographic and Flare Compensation
- Hand Razors
- Smartgun Link
- Wired Reflexes (3)

**Gear**

- Armor Jacket (5/3)
- HK227 S [SMG, 16 (clip), (SA/BF/FA), 5M3 (M), Recoil Compensation (2), w/two extra clips, Smartgun Link (Smartlink)]
- Phone
- Survival Knife (5L3 (7L))

		CONDITION MONITOR			
		LIGHT STUN	MODERATE STUN	SERIOUS STUN	DEADLY STUN
<b>STUN</b>	+1 TN#	+2 TN#	+3 TN#		Unc.
	-1 Init.	-2 Init.	-3 Init.		
<b>PHYSICAL</b>	+1 TN#	+2 TN#	+3 TN#		Unc. maybe dead
	-1 Init.	-2 Init.	-3 Init.		
		LIGHT WOUND	MODERATE WOUND	SERIOUS WOUND	DEADLY WOUND



JIMMY HULLIS 1995

## JETBLACK

Jetblack came from the same mean streets as Allenby, and his early life followed a similar path. Unlike Allenby, however, Jetblack's songwriting and performing talents greatly outweighed his business acumen. A major star in the Seattle area at the age of eighteen, when he signed with Allenby's Caravan Productions, his fame spread to the rest of North America and abroad. Jetblack became one of the first megastars, quickly followed by others like Maria Mercurial, Concrete Dreams, and The Shadows.

Despite his fame, Jetblack's music reveals a troubled man terrified of his own mortality. His best songs focus on themes of death and disaster. Following the classic pattern of neurotic rock stars, Jetblack sank deeper and deeper into depression, and might eventually have self-destructed had fate not intervened.

One of Jetblack's fans, a vampire, recognized his Idol's fear of death. Giving the only help he could, he approached Jetblack and offered the musician the "dark gift" of vampirism. Seeing it as a way to cheat death, Jetblack allowed the vampire to infect him with the HMVV virus.

Too late, Jetblack realized what his new, eternal life might cost. Remaining in the public eye meant his condition would eventually come to light. Would-be "vampire killers" would hunt him down; worse, some of his fans might follow in his footsteps, making what he now recognized as a hideous mistake. Jetblack chose what he considered the only honorable course. He abandoned his career, faking his own death and going underground into hiding. He regrets deceiving his friends, particularly the members of The Shadows, but believes he has no alternative.

A sensitive-looking youth, Jetblack appears to be in his early 20s. His shoulder-length black hair frames a pale, almost elf-like face. His slim, slight build disguises his massive vampiric strength. Since going underground, he has studied the magical arts in the vague hope of reversing his condition, and has become a Grade 0 Initiate.

He leads the Nightstalkers gang. As indicated by the small scars on the gangers' necks, he feeds from them, but not by force; they gladly offer him their Essence and their blood. He never drains more than an individual can afford to give, will never kill them, and never makes new vampires. He feeds on unwilling victims only if they have already tried to kill him. (For instance, Jetblack might feed on Teague in the final assault.)

### Attributes

Body: 2  
 Quickness: 3 x 5  
 Strength: 12  
 Charisma: 6  
 Intelligence: 4  
 Willpower: 2  
 Essence: 10  
 Magic: 7  
 Reaction: 3

**Initiative:** 5 (11) + 4D6

### Dice Pools

Defense (Armed): 3  
 Defense (Unarmed): 2  
 Dodge: 3  
 Magic: 6

**(Threat/Professional Rating: 6/4)**

### Powers

Enhanced Physical Attributes  
 Enhanced Senses (Hearing, Smell)  
 Essence Drain  
 Immunity (Age, Pathogens, Poison)  
 Infection  
 Mist Form  
 Regeneration  
 Thermographic Vision

### Weaknesses

Allergy (Sunlight; Severe)  
 Induced Dormancy (Lack of air)  
 Essence Loss  
 Vulnerability (Wood)

### Gear

Browning Max-Power [Heavy Pistol, 8 (clip), (SA), 4M2 (9M), w/Laser Sight, 2 extra clips]  
 Knife (6L1 (12L))  
 Lined Coat (4/2)

### Spells

**Combat**  
 Sleep: 3

**Detection**  
 Analyze Truth: 4  
 Mind Probe: 5

**Health**  
 Increase Quickness +4: 3

**Illusion**  
 Chaotic World: 2  
 Entertainment: 5

**Manipulation**  
 Mana Barrier: 4

### Skills

Armed Combat: 3  
 Etiquette (Corporate): 1  
 Etiquette (Music Business): 2  
 Etiquette (Street): 4  
 Firearms: 3  
 Sorcery: 6  
 Unarmed Combat: 2  
**Special Skills**  
 Instrumental Music: 6  
 Musical Composition: 7  
 Singing: 7

## CONDITION MONITOR

	LIGHT STUN	MODERATE STUN	SERIOUS STUN	DEADLY STUN
<b>STUN</b>	+1 TN# -1 Init.	+2 TN# -2 Init.	+3 TN# -3 Init.	Unc.
<b>PHYSICAL</b>	+1 TN# -1 Init.	+2 TN# -2 Init.	+3 TN# -3 Init.	Unc. maybe dead
	LIGHT WOUND	MODERATE WOUND	SERIOUS WOUND	DEADLY WOUND

CAST OF SHADOWS



## THE SHADOWS

### MARLI BREMERTON

Lead singer and main songwriter for The Shadows, Marli is tall, slender, and beautiful, with long dark hair. By consensus, she handles most of the band's dealings with the outside world.

**B Q S C I W E M R Armor**  
2 4 3 6 4 4 6 — 4 3/0

**Initiative:** 4 + 1D6

**Dice Pools:** Defense (Armed) 1, Defense (Unarmed) 1, Dodge 4  
**(Threat/Professional Rating: 2/2)**

**Skills:** Armed Combat 1, Etiquette (Corporate) 3, Etiquette (Music Business) 4, Etiquette (Street) 5, Firearms 2, Musical Composition 6, Singing 7, Unarmed Combat 1

**Cyberware:** Voice Modulation with Increased Volume, Tonal Shift, and Playback

**Gear:** Armor Clothing (3/0), Streetline Special [Hold-out, 6 (clip) (SA), 3L1 (4L)]

		CONDITION MONITOR			
		LIGHT STUN	MODERATE STUN	SERIOUS STUN	DEADLY STUN
<b>STUN</b>	+	+1 TNF	+2 TNF	+3 TNF	Unc.
	-	-1 Init.	-2 Init.	-3 Init.	
<b>PHYSICAL</b>	+	+1 TNF	+2 TNF	+3 TNF	Unc. maybe dead
	-	-1 Init.	-2 Init.	-3 Init.	
		LIGHT WOUND	MODERATE WOUND	SERIOUS WOUND	DEADLY WOUND

### JOEY NIGHTMARE

Joey plays lead synth-guitar for the band. Heavy cosmetic modification makes him look like a cross between a devil and an ape. Despite his appearance, he is a soft-spoken, nice guy.

**B Q S C I W E M R Armor**  
4 3 3 5 3 2 3.8 — 3 3/0

**Initiative:** 3 + 1D6

**Dice Pools:** Defense (Armed) 1, Defense (Unarmed) 2, Dodge 3  
**(Threat/Professional Rating: 2/2)**

**Skills:** Armed Combat 1, Etiquette (Corporate) 1, Etiquette (Music Business) 1, Etiquette (Street) 6, Firearms 3, Instrumental Music 7, Musical Composition 3, Unarmed Combat 2

**Cyberware:** Datajack with 100 Mp Memory, Instrument Control Link

**Gear:** Armor Clothing (3/0), Streetline Special [Hold-out, 6 (clip) (SA), 3L1 (4L)]

		CONDITION MONITOR			
		LIGHT STUN	MODERATE STUN	SERIOUS STUN	DEADLY STUN
<b>STUN</b>	+	+1 TNF	+2 TNF	+3 TNF	Unc.
	-	-1 Init.	-2 Init.	-3 Init.	
<b>PHYSICAL</b>	+	+1 TNF	+2 TNF	+3 TNF	Unc. maybe dead
	-	-1 Init.	-2 Init.	-3 Init.	
		LIGHT WOUND	MODERATE WOUND	SERIOUS WOUND	DEADLY WOUND

### SID ID

Sid Id is an elf with waist-length blond hair and gray eyes. He rarely speaks, and when he does, he makes little sense. A terrific synth player and programmer, he also produces The Shadows' recording sessions.

**B Q S C I W E M R Armor**  
3 6 1 1 2 6 3.8 — 3 3/0

**Initiative:** 3 + 1D6

**Dice Pools:** Defense (Armed) 1, Defense (Unarmed) 4, Dodge 6  
**(Threat/Professional Rating: 2/2)**

**Skills:** Armed Combat 1, Electronics 8, Electronics (B/R) 6, Etiquette (Corporate) 1, Etiquette (Street) 1, Firearms 1, Instrumental Music 8, Musical Composition 1, Unarmed Combat 4

**Cyberware:** Datajack with 100 Mp Memory, Instrument control link

**Gear:** Armor Clothing (3/0), Streetline Special [Hold-out, 6 (clip) (SA), 3L1 (4L)]

		CONDITION MONITOR			
		LIGHT STUN	MODERATE STUN	SERIOUS STUN	DEADLY STUN
<b>STUN</b>	+	+1 TNF	+2 TNF	+3 TNF	Unc.
	-	-1 Init.	-2 Init.	-3 Init.	
<b>PHYSICAL</b>	+	+1 TNF	+2 TNF	+3 TNF	Unc. maybe dead
	-	-1 Init.	-2 Init.	-3 Init.	
		LIGHT WOUND	MODERATE WOUND	SERIOUS WOUND	DEADLY WOUND

### ERNEST HAWKINS

Ernest is a short, slight human whose close-cropped sandy hair and large, soft eyes make him resemble a lemur. He moves as slowly as a tree sloth unless something can be gained by moving fast. Though he knows nothing about synthesizer technology, he has a gift for squeezing incredible performances out of the most trashed instruments. In addition to playing synth, he sings back-up vocals and designs the stage light show.

**B Q S C I W E M R Armor**  
2 5 2 4 3 4 3.8 — 4 3/0

**Initiative:** 4 + 1D6

**Dice Pools:** Defense (Armed) 5, Defense (Unarmed) 2, Dodge 5  
**(Threat/Professional Rating: 2/2)**

**Skills:** Armed Combat 5, Etiquette (Corporate) 2, Etiquette (Street) 5, Firearms 4, Instrumental Music 8, Unarmed Combat 2

**Cyberware:** Datajack with 100 Mp Memory, Instrument Control Link

**Gear:** Armor Clothing (3/0), Streetline Special [Hold-out, 6 (clip) (SA), 3L1 (4L)]

		CONDITION MONITOR			
		LIGHT STUN	MODERATE STUN	SERIOUS STUN	DEADLY STUN
<b>STUN</b>	+	+1 TNF	+2 TNF	+3 TNF	Unc.
	-	-1 Init.	-2 Init.	-3 Init.	
<b>PHYSICAL</b>	+	+1 TNF	+2 TNF	+3 TNF	Unc. maybe dead
	-	-1 Init.	-2 Init.	-3 Init.	
		LIGHT WOUND	MODERATE WOUND	SERIOUS WOUND	DEADLY WOUND

CAST OF SHADOWS



## TODAY'S HEADLINES:

### INTERNATIONAL

- Hurricane Ethelbert traveled up the east coast of the UCAS, causing extensive damage along the District of Columbia—New York Corridor. Many areas are under martial law.
- A mysterious blue slime in the Pacific ocean has begun washing up on the shores of New Zealand. The slime, several hundred kilometers in area, was first spotted in open waters this May.

### BUSINESS

- Amid rumors of imminent failure, All-Salish Nations Bank has drastically reduced banking hours and suspended international wire transfers. A bank official said the restrictions were to prevent a bank run until government auditors issue a report.
- Seven major insurance companies will review their policies on cyberinsurance. Currently, policies are only available to corporate employees, but policies may be available to individuals next year.

### ENTERTAINMENT

- This fall's hottest look is the "Garden of Eden." Artificial, (and, occasionally, real) leaves, vines, flowers and fruits will adorn the truly rad this season.
- What is the enduring mystique of the song *Louie Louie*? Musicologist Sonora Quigley explores the nearly century-old hit.

### SPORTS

- North American Basketball Association Commissioner Herb Bass once again denied a petition by Portland, Tir Tairngire, to host a team in the proposed 2055 expansion. "We all know what a disaster Portland hoops turned out to be," said Bass. "It's just a cover-up of anti-elf prejudice," replied Portland Sports Committee spokesperson Kevin Welch.

### LANDMARK BUILDING DESTROYED

C. Kallenbach II

ST. LOUIS—The Moolah Temple building burned down yesterday evening in a five-alarm fire preceded by an unexplained explosion. The cause of the fire remains unknown, though officials speculate that natural gas buildup may be the culprit. Local Bi-Star Police have initiated an arson investigation.

The Moolah Shriners, a charitable organization known for helping crippled children, had used the building for their headquarters for several decades. The intricate brick and mosaic patterns on the Temple facade won the admiration of generations of architectural scholars.

Though the Shriners moved from the building to a new location five years ago, several religious and self-help organizations have based their operations there. The Moolah Temple's current tenant, the Seattle-based Universal Brotherhood, runs a soup kitchen.

### EXECUTIVE SUICIDE

N. Findley

Lone Star officials have identified a body found in a Redmond rooming house as Jonathon Teague, former executive vice-president of Highstar Incorporated, a prominent, Seattle-based entertainment company. Autopsy reports indicate that Teague died by his own hand.

Though Highstar officials expressed sadness over Teague's death, some evidence points to Teague's involvement in illicit operations and betrayal of his fiduciary responsibility. The disgraced vice-president apparently attempted several illegal takeovers of Caravan Productions, the company currently managing The Shadows rock band. Asked about a possible connection between these takeover attempts and the recent murder of Lew Allenby, Caravan's president and sole shareholder, both Lone Star and Highstar remain conspicuously silent.

### FIREWORKS OVER FUCHI

A. Seyberth

Last night's spectacular fireworks display over Fuchi Industrial Electronics announced the company's successful completion of a milestone in the development of its top-secret Symbolic Processor project, according to Fuchi spokesperson Kyle Arigharu. The Symbolic Processor project represents the cornerstone of Fuchi's artificial intelligence research, commonly believed unsuccessful until recently. The announcement of the advance comes as a surprise to the business world, which looked to Renraku Computer Systems to make the next AI breakthrough. Arigharu pointed out that despite the incremental success in the Symbolic Processor's development, Fuchi does not anticipate bringing an AI system online at any time in the foreseeable future.

### BLAST ROCKS SEATTLE U.

E. Wessel and S. Nehring

An explosion rocked the University of Seattle late last night. The blast, which apparently originated in the labs of Dr. Silvus Nyberg, leveled a large section of the main science building's physics wing. No injuries were reported.

Dr. Nyberg is noted for his work in quantum physics and related metaphysical principles. Neither he nor representatives of the University commented on the cause of the blast.

### SECURITY FIRM ATTACKED

C. Kubasik and Staff

CHICAGO—An apparent attack on the Chicago offices of Crusader Security two nights ago may be linked to reports of racial violence and rioting at the Byrne Projects earlier that same evening. Though Crusader spokespersons refused to comment, sources indicate that a gang of orks and trolls attacked the Crusader offices in retaliation for metahuman deaths at the Byrne Projects.

## TODAY'S HEADLINES:

### INTERNATIONAL

- Hurricane Ethelbert traveled up the east coast of the UCAS, causing extensive damage along the District of Columbia—New York Corridor. Many areas are under martial law.
- A mysterious blue slime in the Pacific ocean has begun washing up on the shores of New Zealand. The slime, several hundred kilometers in area, was first spotted in open waters this May.

### BUSINESS

- Amid rumors of imminent failure, All-Salish Nations Bank has drastically reduced banking hours and suspended international wire transfers. A bank official said the restrictions were to prevent a bank run until government auditors issue a report.
- Seven major insurance companies will review their policies on cyberinsurance. Currently, policies are only available to corporate employees, but policies may be available to individuals next year.

### ENTERTAINMENT

- This fall's hottest look is the "Garden of Eden." Artificial, (and, occasionally, real) leaves, vines, flowers and fruits will adorn the truly rad this season.
- What is the enduring mystique of the song *Louie Louie*? Musicologist Sonora Quigley explores the nearly century-old hit.

### SPORTS

- North American Basketball Association Commissioner Herb Bass once again denied a petition by Portland, Tir Tairngire, to host a team in the proposed 2055 expansion. "We all know what a disaster Portland hoops turned out to be," said Bass. "It's just a cover-up of anti-elf prejudice," replied Portland Sports Committee spokesperson Kevin Welch.

## LANDMARK BUILDING DESTROYED

C. Kallenbach II

ST. LOUIS—The Moolah Temple building burned down yesterday evening in a five-alarm fire preceded by an unexplained explosion. The cause of the fire remains unknown, though officials speculate that natural gas buildup may be the culprit. Local Bi-Star Police have initiated an arson investigation.

The Moolah Shriners, a charitable organization known for helping crippled children, had used the building for their headquarters for several decades. The intricate brick and mosaic patterns on the Temple facade won the admiration of generations of architectural scholars.

Though the Shriners moved from the building to a new location five years ago, several religious and self-help organizations have based their operations there. The Moolah Temple's current tenant, the Seattle-based Universal Brotherhood, runs a soup kitchen.

## GANG WAR ON VASHON ISLAND

N. Findley

The quiet of Vashon Island was shattered by gunfire last night at midnight, as a Seattle thrill-gang tentatively identified as the Nightwalkers assaulted a home in Vashon Heights. Security for the residence of Jonathon Teague, executive vice-president of Seattle-based entertainment company Highstar Incorporated, is provided by Hard Corps, Inc. In keeping with the company's sterling reputation, Hard Corps personnel repelled the assault with no casualties and limited property damage. Seattle's Lone Star contingent is currently interrogating surviving members of the thrill-gang.

## FIREWORKS OVER FUCHI

A. Seyberth

Last night's spectacular fireworks display over Fuchi Industrial Electronics announced the company's successful completion of a milestone in the development of its top-secret Symbolic Processor project, according to Fuchi spokesperson Kyle Arigharu. The Symbolic Processor project represents the cornerstone of Fuchi's artificial intelligence research, commonly believed unsuccessful until recently. The announcement of the advance comes as a surprise to the business world, which looked to Renraku Computer Systems to make the next AI breakthrough. Arigharu pointed out that despite the incremental success in the Symbolic Processor's development, Fuchi does not anticipate bringing an AI system online at any time in the foreseeable future.

## BLAST ROCKS SEATTLE U.

E. Wessel and S. Nehring

An explosion rocked the University of Seattle late last night. The blast, which apparently originated in the labs of Dr. Silvus Nyberg, leveled a large section of the main science building's physics wing. No injuries were reported.

Dr. Nyberg is noted for his work in quantum physics and related metaphysical principles. Neither he nor representatives of the University commented on the cause of the blast.

## SECURITY FIRM ATTACKED

C. Kubasik and Staff

CHICAGO—An apparent attack on the Chicago offices of Crusader Security two nights ago may be linked to reports of racial violence and rioting at the Byrne Projects earlier that same evening. Though Crusader spokespersons refused to comment, sources indicate that a gang of orks and trolls attacked the Crusader offices in retaliation for metahuman deaths at the Byrne Projects.

