

CELTIC

DOUBLE-CROSS



CARL SARGENT & MARK GASCOIGNE

FASA
CORPORATION

CELTIC DOUBLE-CROSS



FASA CORPORATION



WHERE **IMAGE** TAKES PRECEDENCE OVER **WISDOM**

WHERE SOUND BITE POLITICS ARE SERVED TO

THE **FAST FOOD CULTURE**

WHERE STRAIGHT TEETH IN YOUR MOUTH

ARE **MORE IMPORTANT** THAN THE **WORDS**

THAT COME OUT OF IT

RACE-BAITING IS THE WAY TO GET **SELECTED**

WILLIE HORTON OR

WILL HE NOT GET **ELECTED** ON...

TELEVISION, THE DRUG OF THE NATION

—**TELEVISION, THE DRUG OF THE NATION**

THE DISPOSABLE HEROES OF HIPHOPRISY



FASA CORPORATION

TABLE OF CONTENTS

FADE TO DUSK: A Prologue	4
INTRODUCTION	5
Gamemastering Notes	5
Character Nationality	5
Shadowrun Rules	6
Making Success Tests	6
Success Tables	6
How to Use This Book	6
Preparing the Adventure	7
Plot Synopsis	7
THE ADVENTURE	
Pack Those Suitcases!	10
Let's Get Elected	13
Kiss the Tarmac	17
Don't Ask For Scotch	19
Dark Blue Eyes	25
Terror in the Dark	27
When the Smoke Clears	32
Night Stalkers	40
Red Haze	42
Green Heat	48
Political Gambit	50
Plants With Attitude	52
Endgame	57
PICKING UP THE PIECES	59
If the Team Falls	59
If the Team Succeeds	59
Deal With the Man	59
Elven Concord	59
Police Informants	59
O'Toole Connection	60
Awarding Karma	60
Team Karma	60
Individual Karma	60
LEGWORK	61
Contacts	61
Hot Information	61
Characters	62
Organizations	65
CAST OF SHADOWS	67
Nathair MacSweeney	67
Bridgit O'Toole	68
Petra Johnson	69
Mairtin O'Neill	70
Dominic O'Brien	71
PLAYER HANDOUTS	73

CELTIC DOUBLE-CROSS

Writing

Carl Sargent (and Marc Gascoigne)

Development

Tom Dowd

Editorial Staff

Senior Editor

Donna Ippotilo

Associate Editor

Sharon Turner Mulvihill

Editorial Assistants

Diane Piron-Gelman

Rob Cruz

Production Staff

Art Director

Jeff Laubenstein

Project Manager

Steve Bryant

Cover Art

Doug Andersen

Cover Design

Steve Bryant

Jim Nelson

Illustration

Tom Baxa

Joel Biske

Steve Bryant

Mike Jackson

John Paul Lona

Karl Waller

Cartography

Ernesto Hernandez

Radley Masinelli

Jim Nelson

Layout

Mark Ernst

Production Assistant

Joel Biske

SHADOWRUN® is a Trademark of FASA Corporation registered in the U.S. Patent office. CELTIC DOUBLE-CROSS™ and TIR NA NOG™ are trademarks of FASA Corporation. Copyright © 1993 FASA Corporation. All Rights Reserved. Printed in the United States of America. Published by FASA Corporation P.O. Box 6930 Chicago, IL 60608

FADE TO DUSK: A Prologue



The emissary from Portland made Nathair uneasy. The choice he had so long awaited had come upon him, and it made him nervous. "Friend, you ask a great deal. Why should I involve myself in this matter between the Seelie Court and my princely cousin by law? I do not care for the role of a go-between."

"But you hate your man," the tall elf from Portland said, a note of urgency creeping into his speech.

"You and I have both seen the poisoned dregs of Humanis, the bitter and resentful individuals who respond to his thinly veiled message of hate. He's very careful, Corrame; he never openly espouses their cause, but he accepts the support of those twisted creatures behind the scenes. Master of the political tightrope he may be, but he cannot hide his hate for us. I can see it in his patronizing manner. He cannot help it; he tries so hard to be

friendly, to act like a man of the people. But he is blind as well. He doesn't see that I know his true nature. Enough of this; what can you tell me about him?"

Nathair's companion leaned forward and set his green-tinged glass down on the marble table. "His closet hides a little skeleton. It has remained hidden a long time, the evidence of it... *liquidated*, shall we say. Luck, however, favors us; a straw in the wind has blown our way. Your man owes people who are about to call in the debt."

Nathair gave a nervous cough. He tried to relax, tried to conceal the excitement that gripped him. "Tell me what you know."

The emissary smiled. "A meeting is going to take place in Tír na nÓg. A very special meeting, mark you. Your man won't attend in person, but a senior aide will. You will most likely be chosen, as you are his expert on Tír na nÓg. I can suggest a way to create a nasty mess at this meeting that will sink your man for good. He will be wiped out, ruined, never to carry a single vote or district again."

Having delivered this pronouncement, the elder elf sat back and watched Nathair with narrowed eyes. Nathair met his gaze evenly, trying not to show his eagerness too overtly. To succeed at the kind of intrigue Corrame and his ilk prized, one needed to display self-control. The elder elf must have liked what he saw, for he continued with a wider smile. "There is also your family to consider; they would appreciate your help in a certain matter. Are you willing to listen?"

Nathair smiled. The tension left his shoulders, and his hands released their grip on the arms of his chair. He nodded, mute, as Corrame raised his glass.

"You'll need to get some strangers into the entourage, Nathair. Some scapegoats to shoulder the blame."

"Easily accomplished. He has had one or two problems with security recently; if I made a discreet suggestion about adding some new faces for extra protection—peripheral surveillance, perhaps—my requests would surely be granted. Yes, I can arrange that." Nathair knotted his fingers together and closed his eyes, thinking through the possibilities. "It should work well. When the strike occurs, I can show remorse; after all, I brought in the outside security. I can claim it is my fault that they failed, though I could not have guessed they would turn traitor. He will enjoy the spectacle of an elf abasing himself, and never think to question a word I say. With your help, I can stay in Tír na nÓg and keep the story quiet, for which my employer will be grateful enough to keep me by his side. From there, I can make certain of his ruin, should one raid prove insufficient." Nathair paused for a moment to savor the newly hatched intrigue. "Yes, I like this."

"Then let us talk of a trade," Corrame said. "This file in return for your mediation ..."

INTRODUCTION

Celtic Double-Cross is a roleplaying adventure set in the world of **Shadowrun**.

The year is 2054. Astonishing advances in technology have enabled humans to merge with computers and travel through the electronic netherworld of data called the Matrix. Magic has returned as well, and elves, dragons, dwarfs, orks and trolls have assumed their true forms. Megacorporations, rather than superpowers, rule the world. North America has been Balkanized, and many major European states have disintegrated as well. Moving among this world like whispers in the night are the shadowrunners. Operating along the margins of society, their existence is acknowledged by few, but no one else can perform their secret work.

Celtic Double-Cross takes place in the European nation of Tír na nÓg, formerly Ireland. Much of the time, the shadowrunners have their hands full simply trying to stay alive in this elven nation, as terrorists, paranimals, security squads, and the like target them. Combat skills will come in handy, but social and decking skills will likely prove even more valuable. Above all, the runners must think on their feet in order to survive.

GAMEMASTERING NOTES

Most **Shadowrun** adventures use a decision-tree format. **Celtic Double-Cross** is slightly different. The action follows a linear progression for the first three encounters, then opens into a wide-ranging decision-tree format in which the actions of the player characters determine which of the remaining encounters actually take place. The turning point in the adventure from linear to decision-tree action takes place in **Don't Ask For Scotch**, p. 19; besides allowing players to generate their own encounters, this section includes the itinerary from which the adventure's subsequent encounters spring and a timetable of behind-the-scenes actions that affect what happens to the player characters. Depending on their choices throughout the rest of the adventure, the player characters may succeed or fail in several different ways.

To run **Celtic Double-Cross**, the gamemaster needs a thorough familiarity with the contents of this book, as well as a working familiarity with the basic **Shadowrun** rules and the **Tír na nÓg** sourcebook. The contents of this book are for the gamemaster's eyes only, except for certain items marked as **Player Handouts**. With the exception of the **Tír na nÓg** material, this book contains everything needed to play **Celtic Double-Cross**.

Celtic Double-Cross is designed for a group of five to eight player characters. An experienced decker and at least one character with a high Charisma Attribute and well-developed social skills such as Etiquette, Psychology, and Negotiation, will greatly increase the group's chance of success. In general, brains prove

more useful than brawn in **Celtic Double-Cross**: in this adventure, the runners almost never get to use massive firepower. In terms of defense, a team with at least two experienced magicians has a definite advantage over one dependent on street samurai. Because **Celtic Double-Cross** takes place in an elven nation, human and elven runners have a slightly easier time in this adventure than ork, troll, or dwarf characters.

Celtic Double-Cross combines several approaches to gamemaster information. Most of the encounters are carefully scripted, but occasionally the gamemaster has to wing it when making transitions between encounters, especially if the runners must travel long distances. To aid the gamemaster in his challenging task, each encounter includes hints on how to gamemaster the sometimes sketchy or extremely complex train of events.

Because so much of **Celtic Double-Cross** hinges on what decisions the players make at various times, more than one of the encounters in this adventure are not standard encounters at all. Instead, they serve as resource sections for the gamemaster, outlining different options for player-character activities and encounters that may or may not take place. These non-standard sections also enable the gamemaster to keep track of the various events of the adventure that determine the direction of the storyline.

Certain events in **Celtic Double-Cross** depend on decisions made and actions taken early on that trigger later encounters, requiring the gamemaster to keep close track of the runners' actions. For example, because police agents hunt the runners for a substantial part of the adventure, certain actions such as plugging into the Matrix for information increase the probability that the police will catch up with their quarry. Should the runners need vital information from the Matrix, they will simply have to bear the risk and deal with the consequences. Beginning with the encounter **Don't Ask For Scotch**, the gamemaster must keep track of such visible actions to determine what happens later on.

CHARACTER NATIONALITY

Celtic Double-Cross assumes that the player characters are from North America. British characters or runners from other lands where English is a first language can be substituted without much difficulty, though Brits may be at something of a disadvantage (see **Don't Ask for Scotch**, p. 19). Native-born Irish runners can also be used, but this choice requires more work by the gamemaster to adapt the adventure and maintain the challenge for the players. For example, native Irish characters would find it much easier to handle communications, contacts, and so on, and so the gamemaster may choose to increase target numbers in those areas to keep the adventure interesting.

SHADOWRUN RULES

Celtic Double-Cross uses **Shadowrun, Second Edition (SRII)** rules. All information, specifically game statistics, appears in that format. Gamemasters still using the first-edition **Shadowrun** rules will need to make a few adjustments to non-player character statistics and weapon and spell statistics.

MAKING SUCCESS TESTS

During the course of **Celtic Double-Cross**, the players will make a number of Success Tests using an Attribute or skill and a given target number. These Success Tests are indicated by the name of the appropriate Attribute or skill and the target number in parentheses. For example, a Stealth (4) Test refers to a Stealth Success Test with a Target Number of 4.

SUCCESS TABLES

At times, the gamemaster will use success tables to determine how much information the players receive from their inquiries and investigations. Each success table lists different information for different numbers of die roll successes. Rolling a high number of successes always reveals the information for the lower number of successes as well. For example, a character rolling 3 successes would learn the information for 3 successes as well as the information for 1 and 2 successes.

HOW TO USE THIS BOOK

In addition to the basic **Shadowrun** rules, the gamemaster must have the **Tír na nÓg** sourcebook with its vital background information on the adventure's location to run **Celtic Double-Cross**. For players interested in the magic used in **Celtic Double-Cross**, **Grimoire, Second Edition (Grimoire II)** is strongly recommended. The **Tír Talnngire** sourcebook may suggest ways in which the gamemaster can use the intrigues of **Celtic Double-Cross** to create subsequent adventures in North America, assuming any surviving runners return there after this adventure. The **Street Samurai Catalog** and the **Neo-Anarchists' Guide to Real Life** may also prove useful.

Because the runners are in a foreign land, they will not have time to establish contacts outside of the interactions in scripted encounters. They may be able to communicate with contacts in America or Britain using vidphones and the like, but such traceable communications may prove hazardous. Bereft of a source of support usually present in a **Shadowrun** adventure, the player characters must rely on their own wits and resources to a greater extent than usual.

The gamemaster should read through this entire book before beginning this adventure, and should also carefully examine all maps, plans, and diagrams. The gamemaster must be thoroughly familiar with the storyline in **Celtic Double-Cross**, because certain actions by the player characters trigger reactions by hostile NPCs. Scheduling breaks in the adventure may also be necessary; for example, if runners lost in the wilds of County Donegal decide to head back to Dublin for help, both players and gamemaster will have to spend considerable time planning the trip. Given the sheer amount of improvisation built into this adventure, the players will

need time to form provisional plans and the gamemaster will need time to invent new obstacles for the runners. The text provides plenty of options for the gamemaster to consider, which he must tailor to the player characters' actions.

This book tries to cover all the events likely to occur in this adventure. The **Plot Synopsis** below summarizes in detail both the story background and the possible courses and outcomes this adventure was designed to follow. Within this synopsis, the first mention of names of places and people important to **Celtic Double-Cross** appears in **boldface** type.

The adventure begins with the encounters entitled **Pack Those Suitcases** and **Let's Get Elected**. These encounters bring the runners into the adventure as they take a job as security for a prominent New York politician. These encounters include information on the politician, Pat MacNamara, and his top aides that the runners will need. These encounters also give the runners time to do a little legwork to check out the angles before leaving for the Emerald Isle, where the rest of the adventure takes place.

The standard encounters in this adventure begin with a section entitled **Tell It To Them Straight**, which describes the team's location and what is happening to them as though the player characters were already there. Any special instructions or additional information for the gamemaster are printed in **boldface** type. **Gamemaster Notes** in this section usually suggest ways in which the gamemaster may wish to adapt the description to reflect previous events and actions by the player characters.

The following short section, **Hooks**, gives the gamemaster an emotional background with which to fill out the facts of the story. This section suggests images, emotions, sounds, sensations, textures, and so on to convey throughout the scene. The information given varies in form and content from scene to scene, ranging from general themes to specific sensory details. Note that only encounters where such information is useful or particularly relevant contain a **Hooks** section.

Next comes the information entitled **Behind The Scenes**. The real story begins here, and only the gamemaster knows what is really going on. In **Celtic Double-Cross**, this section includes detailed descriptions of the different possible courses of events. Any maps or statistics for minor NPCs needed to roleplay an encounter are included here. Game statistics for major NPCs or those who appear in multiple encounters are listed in **Cast of Shadows**, p. 67.

The final section, **Debugging**, contains suggestions for getting the adventure back on track if things go too far wrong. For example, most gamemasters will not want the runners to get killed off or discouraged too easily. Hints and tips offered in **Debugging** can aid gamemasters in modifying events if the player characters seem likely to get scragged before the real fun begins. Of course, the gamemaster should feel free to ignore these hints and let the chips fall where they may.

Picking Up the Pieces sums up the results of the adventure, both politically and for the player characters personally, and provides tips on awarding Karma to the player characters. This section also provides a few brief outlines for possible future adventures based on the events and characters in **Celtic Double-Cross**.

Legwork contains information the player characters can obtain through contacts, public datanets, or from restricted databases they manage to hack into. Note that restricted information is most often scripted in the text of the encounters. Game statistics and background information on major or recurring non-player characters appears in **Cast of Shadows**.

Finally, the **Player Handouts** provide general information for the players and various newsnet printouts, depending on the actions of the players. The gamemaster should photocopy these pages for the players.

PREPARING THE ADVENTURE

It is impossible to create a published adventure that provides the appropriate opposition level for every diverse group of player characters. Some groups are inherently more powerful than others.

However, **Celtic Double-Cross** evens the odds by taking away certain resources that runners tend to depend on too easily, such as big guns, and making others, such as contacts, more difficult to use. No matter how powerful a given group may be, all player characters in **Celtic Double-Cross** find themselves friendless outcasts in a foreign land, most likely armed with little more than hand pistols and their own intelligence. Skills such as Stealth and Etiquette, various Knowledge Skills, decking ability, and the like will come in considerably handier in this adventure than dermal armor or boosted reflexes. Given the level of physical and magical opposition from officers of the Tir Republican Corps (TRC) in this adventure, big guns and flashy combat spells will make the player characters targets without giving them enough power to prevail. Only by playing it sneaky and subtle can the player characters hope to survive and succeed. Each of the non-player characters in **Celtic Double-Cross** has suggested Threat and Professional Ratings (p.187, **SRII**) and the gamemaster should adjust these as needed to vary the level of opposition the runners encounter.

Some combat does occur during this adventure, however. The key to survival for the runners is knowing when to fight and when to run. A simple tactic such as magical assensing can tell a mage that the TRC officers are too tough to handle; TRC operatives are experienced counter-terrorism experts with exceptional skills and equipment. If a player character fires away without checking out his opposition, let him have it with both barrels. Ideally, the runners should avoid the TRC unless they wish to surrender.

The gamemaster should keep in mind that **Celtic Double-Cross** requires the player characters to stay constantly alert and on their toes. In some of the encounters, runner mortality may skyrocket unless the players are exceptionally cagey. The gamemaster may wish to warn the player characters to use wits over muscle and guile over guts.

PLOT SYNOPSIS

Pat MacNamara? So he's doing it, running for mayor of the Rotten Apple. Well, it was only a matter of time. He's smart, smooth, and slick; maybe the time is right for an independent mayor. His guys are making a big push on voter registration to get the blue-collar vote in, I hear. Don't reckon anyone knows what he



actually stands for. You name it, he's all for it if it'll get him votes. The corps don't feel as threatened as you might expect, because word is he'll kiss the ass of the corporate consortium anytime, despite all the "man of the people" bulldrek. Weird thing is, there doesn't seem to be much dirt on the guy. No smoking bimbos or unexplained campaign donations. He can spell the word "potato," and his spin doctors and image consultants manage his photo-opportunities perfectly. Made his money in commodity trading and construction, and he's worth a few hundred million at least. I don't trust him because some of his blue-collar fans are a little right of sensible for my tastes and he doesn't go out of his way to denounce them, but then he's a politician, isn't he?

—New York subway passenger, interviewed by the British Broadcasting Corporation, August 14, 2053

New York is enjoying that wonderful media feast, a mayoral campaign. The Democratic incumbent is a ditbrain, the Republican nominee is a fundamentalist lunatic somewhat to the right of Attila the Hun, and the usual hundred or so fringe crazies are running on a bewildering variety of deranged, single-issue platforms. In addition to this motley menagerie of political animals, one man is adding some extra interest to the proceedings: **Pat MacNamara**, self-made millionaire businessman, proclaimer of the American Dream, man of the people, scion of Irish peasant stock come across the Pond to make good.

MacNamara wants one thing: power. Ultimately he wants to run for president, but mayor of New York will do for a start. New York makes a good power base, and he figures to milk the Irish vote for everything he can. As part of this strategy, he has chosen to make the traditional pilgrimage to the John F. Kennedy Memorial Park in **Tír na nÓg**. There he can look up his ancestors at the Genealogy Exhibitions, press the flesh with some Tír na nÓg politicians, and rack up photo-ops by the score. Because the Tír government dispenses visas sparingly to foreign journalists, MacNamara can easily manage the prime-time trid photo-ops without facing tough questions from unfriendly American reporters. In addition to making pretty pictures, he also intends to enter into trade talks with Tír na nÓg's communications and transport giant, **O'Toole Transcom**. With guidance (and funds) from this group of corporate heavyweights, MacNamara intends to overhaul New York's transport systems and garner political support from the ever-harassed New York commuters.

The only real skeleton in MacNamara's closet is his connection with **the Mafia**. During a few past exploits that the runners may eventually discover, MacNamara ran up a debt with the Mob, and he owes them more than a few favors. In return for keeping silent, the Mafia wants MacNamara to get hard info on O'Toole Transcom that will enable them to smuggle BTLs into the Tír via their fledgling Irish branch. The Mob also knows how to deliver votes back in the Rotten Apple, adding to their leverage with the would-be mayor. Nervous about Mafia watchdogs and wanting to make certain he can get the paydata they want, MacNamara does not want his usual security people too thick on the ground in the Tír. Complicating the matter, an elven aide has fed MacNamara misinformation about his security staff, fueling the candidate's doubts about them. Because Tír law prohibits large-scale private security forces, and because MacNamara prefers to keep Tír state security around him to a minimum, he wants a group of out-of-towners to handle peripheral security as backup for his personal, skeleton bodyguard. The runners, of course, land the job.

James Wassall, one of MacNamara's aides, recruits the runners. He tells them that because the candidate's internal security has been compromised, MacNamara needs a handful of peripheral security people to observe and report anything unusual at the public events the candidate must attend. Excessive security, such as that provided by the sinister-looking Tír Republican Corps, would conflict with the populist, accessible image MacNamara wants for the photo-ops. So conscious of image is MacNamara that he has even hired an elven image consultant, **Nathair MacSweeney**, to coach him in a few phrases of Gaelic-Sperethiel so that he may exchange greetings with Tír nobility on his pilgrimage.

The runners arrive in Dublin with their new employer, and are immediately lulled out of any lingering suspicions about the job by a couple of days of easy money, good living, and no sign of trouble. Free to wander around Dublin while MacNamara looks up family names, plays tourist, and presses flesh, the runners make the most of their time to enjoy themselves. At one of the few public functions they must attend, the runners meet **Bridgit** and **Padraic O'Toole**, the extremely attractive main negotiators of MacNamara's transportation deal. The most charismatic runner attracts the attention of either Bridgit or Padraic, who may prove a valuable contact later in the adventure.

After two days of playing tourist in MacNamara's wake, the runners accompany MacSweeney to the meeting with the Irish Mafia. For this meeting, disguised as a business conference, MacSweeney has secured a distant country house in Donegal, on the other side of the Tír from Dublin. MacNamara does not attend. Instead, MacSweeney and an important MacNamara aide will deliver the information on O'Toole Transcom that the Mob needs, with the runners providing the muscle. The meeting runs smoothly enough, all false pleasantries and hard-faced smiles as the two sides conclude their dealings, until the runners and everyone else suddenly find themselves ducking hot lead. Tipped off to the meeting, local terrorists attack the house in an effort to stymie Mob encroachment into their expanding criminal enterprises. Fortunately, they don't target their initial strikes accurately. Assuming the runners do not hang around to trade pistol rounds against mortars and heavy weapons, they manage to get out alive. Whisked out of harm's way by a helicopter, a livid MacSweeney accuses the runners of leaking the location of the meeting, because only he and they knew of it.

In reality, MacSweeney tipped off the terrorists himself. Despising MacNamara, the elf hoped to ruin his employer by exposing his involvement with the Mob. Lacking evidence, he had decided that tipping off a local terrorist group to the Mafia meet would produce enough dead mobsters and MacNamara aides to make the Tír police forces more than a little interested in MacNamara's links to organized crime. When his plan goes awry, MacSweeney frames the runners to cover himself, then sneaks back to MacNamara and tells him the runners tipped the terrorists. As further "proof" of his loyalty to MacNamara, he offers to use his Tír family contacts to suppress news of the story. Of course, such family intervention means considerable cash payments, which MacSweeney pretends to deliver to the right people but secretly pockets. Through this scheme, the elf hopes to make himself rich while staying near enough to MacNamara to ensure the candidate's ruin.

Though he does not suspect it, MacSweeney, in turn is being tested by the elves of **Tír Tairngire**. They already have evidence linking MacNamara with the Mob, and have offered to give it to MacSweeney after he proves his trustworthiness by mounting an operation against MacNamara within Tír na nÓg. They have also charged him to handle a certain delicate political matter for his cousin-by-law, the Tír Tairngire prince **Aithne Oakforest**, thus proving his usefulness as a courier for Tír Tairngire. Though the odds are that neither MacSweeney nor the runners will ever learn of this, both the elven aide and the runners are pawns in a larger game.

Abandoned in the middle of a forest by MacSweeney in the wake of the terrorist raid, the runners try to elude the terrorists trying to scrag them. Though they do not realize it immediately, even worse trouble awaits them. Initially, the low-level civilian police force known as the Garda investigates the raid on the manor house, but when it finds evidence of terrorist involvement it calls in the feared Tír Republican Corps. A TRC database holds fabricated information linking one of the runners with the terrorist organization, and the TRC hunt the runners for questioning.



For their part, the runners have little idea of what the meeting involved, who shot them up, or what the frag to do. They try to simply stay alive, find out what they can, and identify who wants them dead. Ultimately, they want to confront those responsible for the whole cluster-frag, especially now that someone has tagged them as terrorists.

As the runners go from the proverbial frying pan into the fire, MacSweeney is happily ensconced with **Dominic O'Brien**, a powerful member of the ruling elven families of Tír na nÓg known as the **Danaan-mór**. MacSweeney is negotiating a favor with O'Brien on behalf of his noble Tír Tairngire cousin. If the runners track MacSweeney down and find evidence of his intrigues, they may be able to blackmail their way out of Tír na nÓg. Otherwise, they will find themselves in deep drek; the Tír authorities believe them guilty of terrorist involvement, which carries a death penalty in the Tír. The elven courts may deal with the foreign runners somewhat leniently, but not by much.

Celtic Double-Cross has more than one possible outcome. In the best case, the runners may bring MacNamara evidence of MacSweeney's activities, which MacNamara's spin doctors can transform into evidence of the renegade elf's Mob links. However, the runners will also have to acquire real drek on MacNamara to persuade him to deal straight with them. If they succeed, this arrangement leaves the future mayor of New York owing the runners a big favor. If the runners fail to get out of the trap MacSweeney set for them, they may end up rotting in a high-security jail or spending their lives on the run from elven justice. The adventure also offers abundant opportunities for the runners to end up as dead meat. If the law catches up with them, they may end up acting as street snoops for the TRC or become cortex-bombed spies for Tír na nÓg.

PACK THOSE SUITCASES

TELL IT TO THEM STRAIGHT

Ain't it wiz how a run always starts with some suit inviting you to dinner through a mutual acquaintance? Well, sometimes it starts when some ding-brained slag with an Uzi tries to geek you. But at least this way you get a free meal out of it. The suit in question goes by the name of James Wassall. He's sittin' across the table from you, scarfin' down fresh lobster and tryin' not to look upset when you splash vino on the pretty tablecloth. What the frag, you don't get to set foot in ritz joints like this one real often.

The suit says he works for a slag who needs bodyguards, and that the slag's own security is potentially compromised, whatever the frag that means. "Although we have a nucleus of optimally trustworthy operatives available for close protection, we need some additional peripheral-surveillance personnel to sustain the ongoing integrity of the security situation."

Likes to jaw, this suit. You wonder if he ever speaks fraggin' *English*. Sounds like a fraggin' politico. But you could use the nuyen, so you try to keep your ears open even as the drivel coming from the Johnson's mouth makes your eyes glaze over. The good news is, the money sounds terrific. The bad news is, the Johnson is a politician, or the next worst thing to one. He wants to buy extra bodies to protect a politico, but he hasn't said the politician's name. Yet.

Drek, you've done some snakebellied-low things in your time but chummin' with a politician is where you draw the line. You make a move to leave, and Wassall ups the nuyen by a whopping slice. Frag. . . whenever people talk about large sums of cred, you can feel your morals getting fuzzy around the edges. To flaming frag-all with scruples; you lean back and keep listening.

"We need people to mingle with the crowd," Wassall explains. "We've already got close-cover bodyguards around the Boss, so you won't be at significant risk. We just want a few people with wide-open eyes to keep us in touch with everything going on at the edges."

Twiddling your crystal wine goblet like you drink from pretty glassware all the time, you speak up. "So what's wrong with Lone Star? Or whoever else handles security in the area?"

Wassall shakes his head. "Where the Boss is going, they don't allow private security, and he'd rather not have too much official security on-site. Full police protection would ruin the Boss' image."

You sit straight up, damned near choking on your wine. "No private security? What is this place, some kind of fraggin' Neo-Anarchist hell?"

"Tir na nÓg," says Wassall. "It used to be Ireland, until the elves took it over. No private security, except by special arrangement. Tir state security comes in black berets, wrap-around

sunglasses, and integrated personal cyberweapons. Needless to say, that is *not* the kind of image that the profile analysts find acceptable for ongoing, interactive media coverage of the Boss at this time. So we need our own people."

Seems reasonable enough. Still, you haven't lived this long without suspecting everything and everyone. "So why us?" you ask, knowing it's a dumb question. Some slag has to do the job; you just happen to be the lucky guys offered the nuyen. Then again, you've never believed in luck.

"First of all, we require operatives unconstrained by the rigid training regimes employed by ordinary security organizations," the suit answers. "We also prefer operatives from outside New York because we can be more confident they will not be contaminated by the difficulties that have led us to consider certain elements of our own security potentially compromised."

Don't that sound impressive? Far as you can tell from all the extra tongue-flapping, the Johnson means that most slags in the Boss' home town hate his guts. That don't sound too good.

"Your names were mentioned and placed on a short list by certain mutual acquaintances," the suit adds.

A short list. Terrific. That means the Johnson may have other runners to see after you. You want it, chummer, better grab it. A few questions tell you that the job is an all-expenses-paid, five-day haul to Tir na nÓg. The pay is 2,500 nuyen per day for each of you, with complete medical insurance thrown in. If you accept, you fly out in two days, and the Johnson wants you to keep dead quiet about where you're going. You get to find out your employer's identity on the morning of your departure for Tir na nÓg, when you show up at Kennedy International for the twelve o'clock noon Aer Lingus Flight 0414 to Shannon International Airport. Wassall wants you at Kennedy by ten a.m. for your briefing. And guess what? The suit's already bought tickets for the trip to the Rotten Apple and beyond.

HOOKS

Set the meeting with Wassall in a ritzy, high-class location. Force the runners to dress well. The proposed trip to such an alien locale as Tir na nÓg may make the runners nervous, if so, play that up until the fat pay rate suckers them in.



BEHIND THE SCENES

Note that the text assumes the meeting does not take place in New York. If it does, the gamemaster should omit any reference to preferring runners from out of town.

For once, everything in this encounter is as it seems, at least as far as Wassall is concerned. As he claims, he is recruiting extra security because MacNamara believes that some elements of his personal security force cannot be trusted. If a wizboy runner nips out to powder his nose and comes back in mind-reading mode, he knows Wassall is not lying to the runners, and that Wassall has arranged a meet with another group of runners on his list.

Despite the already staggering fee, the runners may wish to try upping the price. If the runners make a successful Negotiation (4) Test, Wassall agrees to a 20 percent increase on the offer already mentioned, to a maximum of 15,000 nuyen apiece for five days' work.

Because of the attitude of Tir elves toward other metatypes, Wassall prefers a group of runners with few dwarfs, orks, or trolls. If the team includes several such metatypes, Wassall gently points out that such faces are too conspicuous in Tir na nÓg, and may be reluctant to hire them. One or two may distract attention from the other runners, providing something of an advantage. But if the team includes several such metatypes, the gamemaster might suggest that some players consider running a second-string character and having their ork mercenary (or whatever) take a vacation for a few days.

Under normal circumstances, hermetic mages and shamans would face a special problem. Tir na nÓg demands DNA samples from any visiting mage and requires the mage to accept implantation of a surveillance microchip next to a spinal ganglion. (Don't even *think* about trying to remove it, chummer.) However, in this instance MacNamara can pull strings to arrange entry permits for shadowrunning wizboys without requiring them to undergo these infringements of liberty.

If they ask for a contact number, Wassall supplies the runners with a New Jersey exchange. If they follow him after the meeting, he makes for the restaurant parking lot and takes off in a Phaeton limo with a pair of trolls, one driving and one acting as a bodyguard. A runner tailing the car by conventional means must make a successful Stealth (5) Test to avoid detection by either troll. If the test is unsuccessful, the trolls politely suggest to the runner that he or she can easily wait to meet Wassall again until the briefing in New York, and to go frag himself in the meantime. If followed in a vehicle, Wassall heads for the local airport and takes a flight to New York. If the meeting takes place in New York, he heads for the New Jersey turnpike and into a secure suburban zone.

At this point, the runners may want to find out their employer's identity, check out Wassall, or find some helpful data on Tir na nÓg. Go to **Legwork**, p. 61. If they decide to head straight for their New York briefing, they find the MacNamara retinue at JFK Airport. Go to **Let's Get Elected**, p. 13.

JAMES WASSALL

B 4 **Q** 6 **S** 4 **C** 5 **I** 5 **W** 4 **E** 2.05 **M** — **R** 5 (7) **Armor** 4/2

Initiative: 5 (7) + 2D6

Threat/Professional Rating: 4/4

Skills: Car 3, Etiquette (Corporate) 5, Etiquette (Media) 4, Etiquette (Politics) 7, Firearms 4, Interrogation 4, Negotiation 4

Cyberware: Datajack, Headware Memory (50Mp), Headware Radio w/ECM, Smartlink, Wired Reflexes (1)

Gear: Ares Predator [Heavy Pistol, 15 (clip), SA, 9M], Bug Scanner, Data Encryption System, Micro-Transceiver, Portable Wrist-phone w/Flip-Up Screen, credstick with 40,000¥ balance

The slender-built Wassall stands more than two meters tall, and is moderately good-looking with fine dental work. Sporting a tasteful, understated suit, this well-spoken man has the polished manner and bearing of one who deals regularly with the elite and upper crust. However, observant runners will note an edge behind the facade. Those in the biz can sense that at some time in his life, Wassall worked at something far more dangerous than his current profession. He is loyal to MacNamara as long as he thinks he has a career with the Boss and a good pension at the end of it. He also thinks well of MacNamara's political future, and sees himself connected to the White House in years to come. An ideal fixer for MacNamara, Wassall drinks little and does not indulge in BTLs or smoking bimbos.

CONDITION MONITOR

	LIGHT STUN	MODERATE STUN	SERIOUS STUN	DEADLY STUN
STUN	+1 TN+ -1 Init	+2 TN+ -2 Init	+3 TN+ -3 Init	Unc
PHYSICAL	+1 TN+ -1 Init	+2 TN+ -2 Init	+3 TN+ -3 Init	Unc move dead
	LIGHT WOUND	MODERATE WOUND	SERIOUS WOUND	DEADLY WOUND



TROLLS (2)

Use the Troll Street Samurai Archetype, p. 108 of the **Street Samurai Catalog**, for Wassall's troll companions. The chauffeur also has the Car Skill 5 (Specialization: Passenger Vehicles 7). If the runners try to follow the Phaeton to the airport, they succeed.

CONDITION MONITOR				
	LIGHT STUN	MODERATE STUN	SERIOUS STUN	DEADLY STUN
STUN	+1 TN+ -3 Init	+2 TN+ -2 Init	+3 TN+ -3 Init	Unc
PHYSICAL	+1 TN+ -1 Init	+2 TN+ -2 Init	+3 TN+ -3 Init	Unc maybe dead
	LIGHT WOUND	MODERATE WOUND	SERIOUS WOUND	DEADLY WOUND

CONDITION MONITOR				
	LIGHT STUN	MODERATE STUN	SERIOUS STUN	DEADLY STUN
STUN	+1 TN+ -1 Init	+2 TN+ -2 Init	+3 TN+ -3 Init	Unc
PHYSICAL	+1 TN+ -1 Init	+2 TN+ -2 Init	+3 TN+ -3 Init	Unc maybe dead
	LIGHT WOUND	MODERATE WOUND	SERIOUS WOUND	DEADLY WOUND

GETTING TO THE APPLE

Wassall has arranged a private jet to transport the runners to New York's Kennedy Airport, so they will have no problem bringing their gear aboard. However, getting it onto the plane at Kennedy is a dragon of a different color. See **Let's Get Elected**, p. 13.

DEBUGGING

If the runners turn down the deal, have Wassall come back to them the next day. However, he refuses to raise the fee higher than the aforementioned total of 12,500 nuyen per person plus a 20 percent hike. If the runners hold out for more, they do not get the job.

If the runners try something stupid, such as attacking Wassall and his troll chummers and running off with the Phaeton, they have just given a multi-millionaire New York politician a reason to scrag them. If they leave UCAS, they might stay alive, but to have better than fifty-fifty odds of survival, they had best leave the civilized world entirely.

If the runners demand to know exactly who their employer is, Wassall refuses to tell them, claiming that he must keep security tight. The plane tickets to NY are round-trip, so the runners lose nothing by turning up at Kennedy International for the briefing. If they have problems with the assignment, they can resolve them at the briefing. Wassall may say, "I'm sure we will have no difficulties. The Boss is a fair employer and a popular individual," at the initial meet; with this information, the runners may do some checking if they wish.

If the runners want to stall for time to check Wassall out, Wassall grins and says a day's wait or so is fine with him. However, this request bumps the runners down a few notches on his short list of potential employees. Though he gently pressures them to say yes or no at this first meeting, he is prepared to wait a little while. He gives the runners his New Jersey contact number and tells them to call him with their decision.

If the runners ask about the practical aspects of travel to Tir na nÓg, such as what gear or cyberware they may carry with them and so on, see **Let's Get Elected**, p. 13, for a summary of what they can obtain licenses for. Convey this information to the runners through Wassall.

At this point, the runners can do legwork on Tir na nÓg, James Wassall, and their potential employer. Go to **Legwork**, p. 61. For background information on the Tir, assume the runners have general and unrestricted access to the information in the **Tir na nÓg** sourcebook. Their trip to New York is uneventful; the next encounter takes place at JFK terminal, shortly before the orbital trip to Tir na nÓg. When the runners have done whatever legwork they wish to, go to **Let's Get Elected**, the next section.

LET'S GET ELECTED

TELL IT TO THEM STRAIGHT

Wassall meets you at the terminal at JFK and whisks you off to a VIP lounge. He's got a wad of permits and licenses as thick as an ork's skull for you, but that doesn't mean you can get anything you want past customs in Tir na nOg. If you haven't already checked it out, Wassall tells you what you can take there. Body armor's wiz, but nothing too obvious; after all, you're supposed to be *discreetly* keeping watch. The Tir powers that be will also let you have a hand pistol, basic cybergear including a deck, and low-grade defensive talismongery. But if you want to bring along a spell focus for ripping huge hellblasts through the opposition, forget it. Tir customs keeps heavy-duty offensive magic out of the country. Wassall's people take whatever contraband you have and place it in a secure deposit box at the airport; you can pick it up with your personalized magkeys when you get home. If you get home.

Suddenly, the lounge doors swish open and a miasma of suits descends upon you as the Man and his entourage enter from a stretch limo outside. The bodyguards have no obvious cyberware; glinting chrome does not project the people-friendly image this politician wants. But you guess their long coats are hiding a lot more metal than meat. Unsmiling, they stand in a phalanx as the Man comes over with one of those nice, truly-sincere-and-I-really-mean-that smiles politicians sprout whenever they spot a camera within a hundred meters. Not a wavy black hair on his head is out of place.

"Pat MacNamara, and I'm truly pleased to meet you gentlemen," he says through his perfect dentistry. Nodding to the suits at his sides, he continues. "This is my chief of staff, Caspar Rosenberg; my press secretary, Anthea Brown; and my tour guide, translator, and all-around helpful aide, Nathair MacSweeney. We can't say how delighted we are you could make the trip."

The handshake is as carefully balanced as his entourage: one Jewish guy, a black woman, and a dandelion-eater with an implausible Irish name. You see a Hispanic face in the background, but nobody introduces you to him. Quite a politico, MacNamara; he's got someone to please every voting bloc in New York.

Before you can say anything much beyond mumbling your names, MacNamara disappears. Rosenberg looks at you as if you were a pet cat that had just walked in and drekked on his Persian rug, but the elf and the lady look friendlier. MacSweeney tosses a bulging folder of computer printouts into your laps.

"A little in-flight reading material," he says. "This is the itinerary. You'll have some free time in Dublin, and we expect you to spend it quietly. The museums and art galleries are almost as good as the Met or the Guggenheim; you might enjoy sampling a little culture." Caspar's sneering look says he thinks you need it,

but you ignore him. MacSweeney's still talking, and it might be important. "Memorize where you have to be, and when. Keep a minimum of twenty to thirty meters away from Mr. MacNamara at all times, and use basic surveillance techniques." The elf opens a thin attaché case and removes several wristphones. "At any sign of trouble, use one of these to alert Mr. Rosenberg. Just press the red button *here* to send an automatic radio signal to Mr. Rosenberg and Mr. MacNamara's bodyguards."

Wassall breaks into the dialogue. "I'll brief you during the flight on Mr. MacNamara's engagements and your duties." MacNamara's three inner-circle aides drift back to his side, and the bodyguards surround all four of them as they head toward the departure gate. Wassall shepherds you in their wake. "Please check the permits carefully, and make sure you handed us everything unlicensed. We don't want any trouble at Shannon. You have licenses for pistols, but keep them under your coats at all times unless you absolutely need them. Walk around with visible heat in the Tir and you'll get arrested. Oh, and one final thing: you'll be traveling club class. The Tir authorities know you are with us, but we prefer to play down your association with us in case the wrong people are keeping tabs on Mr. MacNamara. Nothing personal."

Welcome to second-class travel. So much for the free champagne.

HOOKS

If you have ever passed through John F. Kennedy International Airport in New York, you can skip this section. If not, read on.

Mayhem. Chaos. Pandemonium.

JFK is a living, breathing example of chaos theory; everything can and does happen, though no one can predict any of the events that might occur. Despite the mayhem, however, things get done. People reach their gates, planes arrive and depart close to schedule, bags get properly routed, and so on. JFK International is chaos in action.

Traveling with MacNamara and his entourage, the runners experience the spotlight effect. When MacNamara pays attention to them, *everyone* pays attention to them. When he loses interest, the spotlight of public notice dims. Use this attention to play up the runners' paranoia. Wassall told them of his concerns about MacNamara's security, but he never went into detail. Is the old lady near the cash machine watching the runners? What about the group of Euro-hooligans on their personal world tour? The biggest one keeps looking at the runners. Is he memorizing their faces, or planning to pull a move? Airport security, of course, poses its own problems. Remind the runners that at least one security camera is tracking them at any given time.



BEHIND THE SCENES

The most important aspect of this encounter is paperwork. If the runners have not already obtained a list of what they can import into Tír na nÓg, they get it now. The Items Wassall mentions in **Tell It To Them Straight** give the gamemaster clear guidelines. The player characters may bring with them simple body armor, but no heavy security or military-issue armor; hand weapons, up to and including heavy pistols; cyberware and basic-level cyberdecks; and non-offensive talismans, spell foci, and so on. Obscure items or those whose offensive power is indeterminate are allowed at the gamemaster's discretion, with the following caveat: if in doubt, reject it. For guidelines on UCAS airport security, see **The Neo-Anarchist's Guide to Real Life** and the multi-part adventure **Harlequin**. Base the airport security level on what the player characters try to sneak aboard the plane. They should find most items difficult to carry or smuggle onto the plane; if they try something silly, such as packing an AK-97 or a grenade launcher, let airport security smack them right between the eyes with every regulation in the book. If the runners ask, Wassall tells them not to expect additional weapons to be provided in Tír na nÓg. The runners are only to act as observers; government-provided security and MacNamara's personal bodyguards will handle the heavy firepower should it become necessary. Wassall himself is none too pleased with that arrangement, but the Tír government strictly enforces the law.

The tour itinerary is a particularly important piece of paperwork, and the gamemaster must be sure to give it to the players (**Player Handouts**, p.73). Once they arrive in Tír na nÓg, the runners may wish to do some legwork on places and people mentioned in the itinerary. If they have simple questions for Wassall or others in the entourage about Tír na nÓg locations and so on, refer them to the information in the **Tír na nÓg** sourcebook. If the runners ask questions about Pat MacNamara during the flight, give them the information listed for 1 success under MacNamara's entry in **Legwork**, p. 62.

Finally, Wassall and Rosenberg mercilessly harass any runner who looks like a refugee from a mens' movement or punk revival. Image is everything to them, and they refuse to tolerate anyone

in the traveling group who look like a street punk. Rough edges and a little attitude may be somewhat desirable to discourage attack, but anything bolder is frowned on.

MAJOR ENTOURAGE MEMBERS

Game statistics for Nathair MacSweeney appear in **Cast of Shadows**, p. 67. Statistics for the other major entourage members are given below.

Patrick Seamus MacNamara

B	Q	S	C	I	W	E	M	R	Armor
3	5	4	7	5	5	4.8	-	5 (7)	3/1



Initiative: 5 (7) + 2D6

Threat/Professional Rating: 4/3

Skills: Etiquette (Corporate) 5, Etiquette (Media) 8, Etiquette (Political) 7, Firearms 3, Leadership 6, Leadership (Political) 8, Negotiation 5, Psychology (Group Behavior) 5

Special Skills: Commodity Speculating 6, Knowledge (Construction Industry) 6

Cyberware: Beta-customized Wired Reflexes (1)

Gear: Ares Predator [Heavy Pistol, 15 (clip), SA, 9M], Form-fitting Body Armor [Level 2 (3/1)], Pocket Secretary, Zena-Suisse Gold Portable Wrist Vidphone, unlimited amounts of Tres Chic clothing, unlimited funds (give or take a few hundred million nuyen.)

Though Pat MacNamara is a major non-player character, the runners do not deal with him directly, and so the gamemaster does not need a full profile.

Pat MacNamara is 48 years old and stands just over two meters. Ever image-conscious, he keeps his wavy black hair carefully coiffed. He has handsome (but not *too* handsome) features, friendly brown eyes, and a perfect smile. Lately, his voice has developed a noticeable brogue. For other, relevant details of his background, see **Legwork**, p. 62.

CONDITION MONITOR

	LIGHT STUN	MODERATE STUN	SERIOUS STUN	DEADLY STUN
STUN	+1 TN+ -1 Init	+2 TN+ -2 Init	+3 TN+ -3 Init	Unc.
PHYSICAL	+1 TN+ -1 Init	+2 TN+ -2 Init	+3 TN+ -3 Init	Unc. maybe dead
	LIGHT WOUND	MODERATE WOUND	SERIOUS WOUND	DEADLY WOUND

Caspar Rosenberg

B Q S C I W E R Armor
4 5 4 6 6 5 4.68 5 2/0



Initiative: 5 (9) + 3D6

Threat/Professional Rating: 2/3

Skills: Car 3, Electronic Warfare 4, Etiquette (Corporate) 5, Etiquette (Media) 6, Etiquette (Politics) 8, Interrogation 5, Leadership 4, Negotiation 5, Psychology (Group Behavior) 4

Cyberware: Beta-customized Datajack, Headware Memory (200 Mp)

Gear: Form-Fitting Body Armor [Level 1 (2, 0)], Pocket Computer (10 Mp memory), 2 Pocket Secretaries, Portable Vidphone, 75,000 nuyen in credsticks and currency

Note: Rosenberg also carries the central controller for the runners' wristphone alarms. Whenever one of them is activated, it triggers a mild electric pulse to Rosenberg's wrist. A slaving device alerts MacNamara's regular bodyguards at the same time.

Caspar Rosenberg is a tall, dark, lean-faced man in his early fifties. Patronizing toward all the other members of MacNamara's entourage, he wears immaculate suits and keeps himself perfectly groomed. Technically Wassall's boss, Rosenberg uses Wassall as an intermediary to spare himself the indignity of dealing personally with the runners. For more background on Rosenberg, see **Legwork**, p. 63.

CONDITION MONITOR

	LIGHT STUN	MODERATE STUN	SERIOUS STUN	DEADLY STUN
STUN	+1 TN+ -1 Init	+2 TN+ -2 Init	+3 TN+ -3 Init	Unc
PHYSICAL	+1 TN+ -1 Init	+2 TN+ -2 Init	+3 TN+ -3 Init	Unc maybe dead
	LIGHT WOUND	MODERATE WOUND	SERIOUS WOUND	DEADLY WOUND

Anthea Brown

B Q S C I W E R Armor
3 4 2 6 6 5 4.68 5 -



Initiative: 5 + 1D6

Threat/Professional Rating: 4/3

Skills: Car 3, Computer 4, Etiquette (Corporate) 3, Etiquette (Media) 9, Etiquette (Politics) 5, Etiquette (Street) 3, Law (Corporate) 3, Law (Media) 5, Negotiation 5, Stealth 2, Unarmed Combat 5

Cyberware: Beta-customized Headware Memory (200 Mp), Datajack

Gear: Effectively unlimited possession of communications-related items such as laptops, vidphones, Pocket Secretaries; 3 suitcases of Tres Chic clothing

Svelte and always smartly dressed, MacNamara's 35-year-old press secretary Anthea Brown boasts an extensive background in corporate and media law. Relentlessly efficient, Brown expertly deflects intrusive questions aimed at her candidate and personally scripts all of his public statements. During the Tir na nÓg trip, she oversees his campaign speeches and sound bites. Because of her seniority within the organization and her heavy work load, Brown will not waste time talking to the runners beyond an initial exchange of pleasantries. As a practitioner of meditation exercises and the ancient Japanese martial art of *ju-jitsu*, she can hold her own in most situations.

CONDITION MONITOR

	LIGHT STUN	MODERATE STUN	SERIOUS STUN	DEADLY STUN
STUN	+1 TN+ -1 Init	+2 TN+ -2 Init	+3 TN+ -3 Init	Unc
PHYSICAL	+1 TN+ -1 Init	+2 TN+ -2 Init	+3 TN+ -3 Init	Unc maybe dead
	LIGHT WOUND	MODERATE WOUND	SERIOUS WOUND	DEADLY WOUND

Petra Johnson

Though not a VIP, Petra Johnson plays a potentially vital role in **Celtic Double-Cross**. Petra is Anthea Brown's assistant, and monitors the media. If the runners make an effort to befriend her, Johnson may prove a useful contact. A profile of Petra Johnson appears in **Dark Blue Eyes**, p. 25. For complete game statistics, see **Cast of Shadows**, p. 69.

Bodyguards

For MacNamara's six personal bodyguards, use the Bodyguard Archetype, p. 49, **SRII**, with the following modifications. In addition to the gear listed, MacNamara's guards have Beta-customized Wired Reflexes (3). This cyber modification gives them Essence .4, Reaction 11, and Initiative 11 + 4D6. Give them Threat/Professional Ratings of 6 and 4 respectively. Condition monitors for the bodyguards appear at the end of this book.

MINOR AIDES

MacNamara's retinue also includes some other individuals not given game statistics because the runners do not interact with them and they play no role in the adventure. The following notes provide basic information about these individuals that can be shared with the players. The entourage does not include the usual journalists, photographers, and other media reptiles because of Tír na nÓg's reluctance to admit foreign media into the elven nation.

Peter Lewis

A short, ugly man of medium height and build, somewhere close to 40, Lewis is MacNamara's top spin doctor. Lewis himself prefers the title of image-profile analyst. Use the City Official Contact for Lewis (p. 204, **SRII**), adding the following skills: Etiquette (Media) 10 and Psychology 9.

Xavier Almodovar

Handsome and well-dressed, 35-year-old Almodovar takes care of business communications between MacNamara and his stateside companies when MacNamara is abroad. A financial workaholic who sleeps only four hours a night, Almodovar keeps to himself and studiously avoids the runners. Use the Decker Archetype (p. 51, **SRII**) for Almodovar; in addition to those statistics, he also has Browse 8 and Analyze 8 programs, plus others as the gamemaster determines. Almodovar travels with a Fuchi Cyber-7 deck.

DEBUGGING

Little can go wrong in this encounter. In all likelihood, the runners will only show up at the airport if they have decided to take the job. If they stage any last-minute haggling over the fee, Wassall gets furious with them because they are showing him up in front of his superiors. Rather than increasing his offer, he tells the runners to step back into line or else he will make their lives distinctly unpleasant. Hopefully, the runners will back down; a few extra nuyen are not worth making powerful enemies. If they back off, Wassall calms down and tells them curtly that he will forget their incivility. Roleplay him as cursory and curt for a while; eventually, he resumes his normal demeanor toward the runners.

If one of the runners takes his wristphone apart to find out what's really inside it, he finds the radio signaling alert. Nothing else. Surprise. Unless the runners want to do some fast legwork, such as disappearing into the airport toilets with a cyberdeck to check a few archives or making quick phone calls to contacts, go to **Kiss the Tarmac**, the next section.



KISS THE TARMAC

TELL IT TO THEM STRAIGHT

The orbital touches down on a rainy day at Shannon International. As he exits the craft, MacNamara does the usual hand-waving drek. Careful to keep his good side toward the plethora of local media boys on hand, he actually drops and kisses the ground of what you can hear him call "this blessed country." Thanks to a plush knee pad some Tír functionary places in front of him just in time, he doesn't get the knees of his very expensive pants wet. His smile flashes as he shakes hands with Samuel O'Kennedy, the Tír foreign minister. From the glossy pix included with your briefing documents, you recognize the figure of treasury minister, Richard O'Toole lurking nearby. Both government slags are high-ranking elves of the *Danaan-mór* who run the Tír; these dandelion-eaters must be taking MacNamara seriously. Beefing up MacNamara's own limited security, the Tír Republican Corps has a formidable presence at a discreet distance. The black berets lurk along the crowd's edges, just where Wassall wants you to be. Keeping a respectful distance from the politicians, you head for customs. Better hope no one's carrying anything you don't have licenses and permits for, chummers.

HOOKS

Welcome to the Tír, chummer. Welcome to *weird*.

To a foreigner, this elven nation is among the strangest places on earth, even more so than Tír Tairngire. Within Tír na nÓg, the rest of the world hardly seems to exist: the country exists alone in its own special universe. Clothing styles are a bizarre mélange of post-modern and retro-fantasy. Stiff formality and incomprehensible rituals mark all social interaction. Where noticeable, technology almost completely lacks the usual bells and whistles screaming "This is wiz! Check it out!" Instead, simplicity and invisibility are the key design elements.

BEHIND THE SCENES

The arrival at Shannon, a small sprawl built around one of the Tír's two international airports, is part of a whistle-stop tour for MacNamara. Once he has pressed the flesh with O'Kennedy and O'Toole, a private jet will ferry him, the elven ministers, the runners, MacNamara's bodyguards, and half a dozen TRC men to Dublin. In Dublin the president of the Tír will welcome MacNamara. Later in the evening, just in time for North American prime-time vidnews, MacNamara will join the president and other Tír politicians for drinks.

The runners must go through customs, then hop back out on the tarmac and board the private jet. A smart team should realize that such a warm welcome for MacNamara by powerful elves in the Tír na nÓg government turns a bright spotlight on them. All this public attention from powerful people makes Shannon Airport a bad place to try smuggling contraband. Nevertheless, the runners may try to smuggle in something they should not. (They are runners, after all.) If they do, Shannon's airport security discovers it. Extremely tight even at ordinary times, security has been beefed up for MacNamara's arrival. The Garda, the Tír's mostly human, civilian police force, have men backing up the regular customs officials. Garda officers wear black uniforms with white edging and flat white caps, and carry AET NN-15 heavy pistols (treat as Remington



Room sweepers; see also p. 152. **Tír na nÓg**), tasers and shock batons. The Tír Republican Corps (TRC) personnel sport jet-black uniforms with black berets and the ubiquitous wrap-around sunglasses; almost all of them are elves. They carry tasers, NN-15s, and SMGs, wear heavy armor, and do not talk much.

If the runners challenge Tír authority during this encounter, deploy a Reach Fuileach member as part of the airport security team. The Reach Fuileach ("bloody body"), a sub-unit of the TRC, are the deadliest assassins in Tír na nÓg (see p. 152, **Tír na nÓg**). Though they wear uniforms similar to standard TRC-issue, the *Reach* boast magical armor and spell locks. They are also physical

adepts. For a complete description of the typical TRC operative, see Mairtin O'Neill's profile in **Cast of Shadows**, p. 70.

If any runner is caught with a controlled item for which he has no permit, Wassall deals with the matter. The Tír authorities confiscate the item, levy a fine, and allow the runner to stay free on bail without attending his court hearing. However, if the item is something stupid such as a military weapon, throw the runner jail and give him an appropriate jail sentence. End of adventure for that offender.

Following the terms of the runners' contracts, any smuggling infraction reduces their agreed fee by 75 percent. By law, they must also surrender their passports to the Tír authorities. For attracting this kind of unwelcome attention right out of the starting gate, the runners have given themselves the equivalent of 4 visible actions. (For information on visible actions, see **Don't Ask for Scotch**, p. 19.)

Any decker or mage gets full treatment from security. The permits Wassall gave them should help the runners avoid trouble, but the gamemaster should feel free to harass them if it seems appropriate.

DEBUGGING

Dealing with security at Shannon offers the gamemaster a way to impress on the runners the power of the TRC. These slots are *not* to be fragged with; this realization becomes important in the later stages of the adventure. If a runner tries to give a TRC officer sarcastic drek at the airport, fire a verbal warning shot at the offender. If tempers get out of hand, have Mairtin O'Neill arrive to take charge. This action sets O'Neill up as the nemesis that he will become for the runners later in the adventure.

Profiles for Garda members and other airport security are not given for this encounter, because any violence at Shannon can only end with dead or imprisoned runners. The gamemaster should not waste time with combat. With their superior numbers and preparedness, the TRC can squash the runners like bugs.

From here, go to **Don't Ask for Scotch**, the next section. Not a standard encounter, **Don't Ask for Scotch** outlines options for play prior to the turning point of this adventure (**Terror in the Dark**, p. 27.)



DON'T ASK FOR SCOTCH

Not a standard **Shadowrun** encounter, this section provides the gamemaster with game information vital to the continuation of **Celtic Double-Cross**. The section entitled **Visible Actions**, below, introduces and defines a new game concept specific to this adventure and provides guidelines for dealing with visible actions taken by the player characters. The following sections provide the gamemaster with an itinerary for keeping track of the adventure's subsequent events and encounters, as well as options and suggestions for encounters and developments that occur during the player characters' two days of free time in Dublin. During this time period, the players initiate their own encounters rather than depending on the gamemaster to direct the action from the scripted adventure. However, the gamemaster must still keep one step ahead of the players and integrate their improvised encounters with the events listed in the gamemaster's itinerary, p. 20. The gamemaster may insert improvised encounters anywhere he deems fit in the runners' free periods, proceeding to written encounters as indicated in the itinerary.

VISIBLE ACTIONS

Visible actions are any actions the runners may take that draw the attention of the authorities. Though the Tir authorities already know about the runners, the team's actions determine whether the authorities view them as a nuisance or a menace. This judgment becomes important later in the adventure. The greater the threat the runners appear to pose, the heavier the security Tir authorities send to deal with them. The number of security personnel encountered, their reactions, and how quickly they find the runners all depend on how much trouble the runners create.

Besides such obvious acts as public violence, serious infringement of laws, and so on, visible actions may also include subtler actions. For example, dating Bridgit O'Toole (see **Dark Blue Eyes**, p. 25) might draw attention. Bridgit is the daughter of Seamus O'Toole, a politically powerful man. If he learns that a runner is seeing his daughter, he arranges to have that runner tailed and digs for all the information on him that he can find. Any attempt by the runners to communicate with contacts back home by phoning or even decking might also constitute a visible action, because the Tir authorities monitor Matrix and vidphone communications.

Some encounters list visible actions the runners may perform. In other encounters, the gamemaster determines what constitutes a visible action. Because **Celtic Double-Cross** contains periods of downtime for the player characters, runners have more freedom to act than in the standard **Shadowrun** adventure. They may go off to the opera, visit Dublin's museums, or drink themselves stupid on Guinness and brawl with the local gutterpunks. During this downtime, the gamemaster can add any player-character activities to the team's visible action tally as he sees fit. The visible

actions listed in certain encounters provide the gamemaster with a guideline for making his decisions. Above all, the gamemaster should strive to be consistent.

VISIBLE ACTION TALLY

In order to determine the degree of menace that the runners pose to the Tir, the gamemaster must keep track of all visible actions the runners take during the adventure, both during their free time in Dublin and at other times. He should keep a running tally of the cumulative number of visible actions taken by the team, including a line or two on the nature of each action. This cumulative visible action tally may be used to trigger or modify events later on in the adventure.

Note that the visible action tally applies to the entire team rather than to individual members. The authorities consider and respond to the runners as a group, and so a visible action taken by one runner affects the tally for the entire team.

POTENTIAL VISIBLE ACTIONS

Though certain visible actions always draw attention, such as dating Bridgit O'Toole or blowing up a police station, other visible actions may or may not draw attention. For example, though Tir authorities monitor transatlantic calls, they do not analyze them all immediately. For this reason, the authorities may not notice the runners' transatlantic call to their New York fixer before the adventure ends. Such an action is a potential visible action.

Whenever a runner performs a potential visible action, the gamemaster may offer the runner the option of expending 1 Karma Point to ensure that the authorities do not notice the action (lucky break, chummer, the government's spying equipment went haywire just as you connected with Seattle by satellite link). Any Karma Points expended in this manner are permanently lost from the team's Karma Pool. If the gamemaster does not offer this option or the runner declines it, roll 2D6. On a result of 6 or greater, the potential visible action draws the attention of the authorities.

PRIOR VISIBLE ACTIONS

Depending on certain factors described below, the runners may already have a visible action tally before actually taking any action in the adventure. Tir immigration checks are thorough, and the authorities will certainly notice anything about a runner that they consider undesirable. If they take exception to a runner for any reason, they will pay closer-than-normal attention to him.

For any runner with a criminal record in his home nation, add 1 to the team's visible action tally; if he has served more than six months in jail, add 2. The maximum increase for criminal convictions is 5.

If any runner has knowingly performed runs for Aztechnology, add 1 point to the tally. Relations between Tir na nÓg and Aztechnology are tense, to say the least, and the Tir authorities will



show extra interest in anyone with links to this megacorporation. Also, add 2 to the tally if any runner is of British nationality. The Tír authorities trust Brits as little as they do Aztechnology and all its works. If half of the team or more is British, add 4 to the tally.

Because Tír na nÓg has a homogenous, white-skinned population composed largely of elves and humans, skin color and metatype also affect the visible action tally. Outside the major tourist sites, anyone with black or brown skin and any troll, dwarf, or ork is easily observed and remembered, making it easier for security forces to locate them. For each non-white or non-elfen metahuman on the team, add 1 to the visible action tally.

GAMEMASTER ITINERARY

A gamemaster's copy of the runners' itinerary appears below. This gamemaster's itinerary includes both official events and events that occur behind the scenes that will affect the runners. Where an event occurs within a written encounter, the appropriate encounter appears in parentheses. The itinerary also includes suggestions for when and where to place the runners' improvised encounters (see **Downtime in Dublin**, p. 22 of this section), where to find background for improvised encounters and itinerary events, and gamemaster hints for running the improvised encounters. These gamemaster notes appear below the scheduled event to which they apply. For all officially scheduled events, the runners' presence is required unless otherwise noted.

DAY 1

10:00 A.M. EST: Arrive John F. Kennedy Airport for briefing (**Let's Get Elected**, p. 13).

12:00 P.M. EST: Orbital flight departs JFK (**Let's Get Elected**, p. 13).

8:00 P.M. GMT: Arrive Shannon International Airport to meet Tír government officials. Customs check (**Kiss the Tarmac**, p. 17).

8:30 P.M. GMT: Depart Shannon Airport for Dublin by private jet. (**Kiss the Tarmac**, p. 17).

9:00 P.M. GMT: Arrive Dublin International Airport. Meet President William O'Dunn and other government officials. Motorcade proceeds to Flathail Hotel, Fitzwilliam Street. Drinks in hotel suites with selected guests (**Kiss the Tarmac**, p. 17).

DAY 2

On Day 2 and Day 3, the runners have considerable free time to wander around Dublin. During this time period, the players will have several opportunities to generate improvised encounters, for which the gamemaster must flesh out the details. Suggested encounters appear under **Downtime in Dublin**, p. 22 of this section; the gamemaster is encouraged to add his own touches.

7:30 A.M. GMT: Breakfast with representatives of the Dublin Chamber of Commerce, Flathail Hotel.

The runners must wander the hotel area adjoining MacNamara's suites, keeping an eye out for trouble. This time, they don't find any. The food sure smells good, chummer.

9:15 A.M. GMT: Motorcade departs from Flathail for tour of assorted cultural sites.

MacNamara's entourage, including the runners, will visit Trinity College and Leinster House. For the third stop, choose something interesting from **Dublin**, beginning on p. 103 of the **Tír na nÓg** sourcebook.

12:00 P.M. GMT: Lunch and reception for Seamus O'Toole and executives of O'Toole Transcom, Flathail Hotel.

This event provides the player characters with an opportunity to meet Bridgit or Padraic O'Toole, in the only written encounter that occurs in Dublin. See **Dark Blue Eyes**, p. 25.

2:00 P.M. GMT: Motorcade departs for visit to the De Valera Habitat of Renraku Éireann-Tír at Dun Laoghaire. Discussions with Renraku executives. **RUNNERS NOT REQUIRED.**

If a few team members want to tag along on this trip, the gamemaster must improvise events based on the limited material given on p. 59 of the **Tír na nÓg** sourcebook.

5:30 P.M. GMT (approx): Return to Flathail Hotel.

The motorcade's estimated time of arrival is anywhere between 5 and 6 p.m. Make the motorcade late. Let the runners sweat.

7:00 P.M. GMT: Dinner reception for Dublin business people, Flathail Hotel. **RUNNERS NOT REQUIRED.**

9:00 P.M. GMT: Reception for prominent Tír businessmen, media personalities, and artists at Bloduedd's Night Club and Restaurant (see p. 114, **Tír na nÓg** sourcebook).

This event offers an opportunity for the runners to continue any liaisons begun with one of the O'Tooles in **Dark Blue Eyes**, p. 25. If necessary, use the Large Restaurant Archetype map, p. 77. From 11:30 p.m. onward, limousines are available to return entourage members to the Flathail.

DAY 3

7:30 A.M. GMT: Family breakfast for members of the MacNamara family living in the Tir. **RUNNERS NOT REQUIRED.**

10:30 A.M. GMT: Motorcade and meet-the-people walkabout. This event should be the mother of all security nightmares.

Play with the runners. Mess with their minds. If the poor slots frag it up, let them suffer real repercussions.

12:00 P.M. GMT: Luncheon with the Mayor of Dublin, the Worshipful Graeme Patrick Finnegan, and members of the Dublin City Corporation, Dublin Castle. **RUNNERS NOT REQUIRED.**

2:00 P.M. GMT: Meeting with members of the Leinster Assembly, Dublin Castle. **RUNNERS NOT REQUIRED.** Though the runners need not attend, they must be outside the offices of Éireann-Tir Tours promptly at 3 p.m. to conduct preparatory surveillance of the premises.

4:00 P.M. GMT: Conference with directors of O'Toole Transcom, Éireann-Tir Tours offices.

The runners must remain within 5 minutes' travel time of this location once the talks begin in case MacNamara decides to make an "impromptu" visit to the DART rail system for a photo-opportunity. This occurs at the gamemaster's discretion. In any event, the runners must be outside the offices by 6:30 p.m. to accompany the entourage back to the Flathail.

6:45 P.M. GMT (approx): Return to Flathail Hotel. Place a couple of Garda cars outside the hotel, lights flashing, to spook the runners. If they investigate, they find that domestic trouble involving a hotel staff member spilled over into the back alley and someone was beaten up.

7:30 P.M. GMT: Motorcade leaves for a dinner with invited guests at Dublin Castle. Following dinner, the Order of Brigid performs musical and poetic entertainments, including a performance of Doncha O'Brien's play *The Destiny of Ages*. The entourage requires no security in the castle, but the runners may dine and observe the cultural events if they wish. However, they must dress formally and behave with due decorum at all times.

11:00 P.M. GMT (approx): Motorcade returns to the Flathail for nightcaps and minor entertainments in hotel suites with a select group of invited guests.

DAY 4

The turning point of the adventure occurs on the evening of Day 4, in the scripted encounter **Terror in the Dark**, p. 27. Because several events that directly affect the runners but have nothing to do with the official itinerary occur on Days 4 and 5, the itinerary for these final two days is divided into **Official Events** and **Events Behind the Scenes**.

Official Events

7:30 A.M. GMT: Breakfast for selected guests at the Flathail. **RUNNERS NOT REQUIRED.**

9:30 A.M. GMT: Motorcade leaves for Dublin Airport, to board private jet to Wexford Airport.

10:45 A.M. GMT: Walkabout at entrance to John F. Kennedy Memorial Park.

11:15 A.M. GMT: Guided tour of JFK Memorial.

12:45 P.M. GMT: Luncheon at the Robert Kennedy Lodge with invited guests.

2:30 P.M. GMT: Guided tour of the Genealogy Exhibition with members of the MacNamara family.

5:00 P.M. GMT (approx): Depart John F. Kennedy Memorial Park for Wexford Airport; from there, depart by private jet for Shannon International Airport and the Inter-Tir Hotel.

6:30 P.M. GMT: Dinner.

8:00 P.M. GMT: Confidential meeting with business representatives from Connaught, at Altan Lodge in Glenveagh National Park. The chaos begins here. For details of the so-called business meeting and its aftermath, see **Terror in the Dark**, p. 27. For details of the events that occur behind the scenes on Days 4 and 5 after MacSweeney sets up the runners, consult the encounters noted in parentheses.

Events Behind the Scenes

8:00 P.M. GMT: False information concerning runners' affiliation with the Irish National Liberation Army (INLA) is introduced into TRC computers. (**Red Haze**, p. 42.)

9:40 P.M. GMT: Nathair MacSweeney, Rosenberg, and their bodyguards return to the Inter-Tir Hotel around 9:40 p.m. and brief MacNamara on the terrorist raid at Altan Lodge (**When the Smoke Clears**, p. 32).

DAY 5

Though Day 5's official events do not begin until 9:00 a.m., considerable clandestine activity occurs in the wee hours of the morning. It is important to note that MacNamara and the bulk of his people, except for MacSweeney, leave the Tir on schedule. The runners have an extra day to deal with MacSweeney, if they wish.

Official Events

9:00 A.M. GMT: Motorcade departs for tour of sacred sites at Knocknarea and Rathcroghan, accompanied by members of the Druidic Order of Ogma.

12:30 P.M. GMT: Lunch at Roscommon Castle as guests of *taoiseach* Martin O'Connor.

3:00 P.M. GMT: Depart by helicopter for Shannon International Airport.

4:00 P.M. GMT: Depart by orbital flight for JFK Airport, New York, UCAS.

Midnight (approx): Arrive at JFK Airport.

Events Behind the Scenes

1:00 A.M. GMT: Petra Johnson overhears an important conversation between MacNamara and MacSweeney (**When the Smoke Clears**, p. 32).

2:15 A.M. GMT: MacNamara spin-control meeting breaks up. The candidate decides to move to another hotel for safety (**When the Smoke Clears**, p. 32).

2:30 A.M. GMT: The MacNamara entourage quietly relocates to the Shannon Bridge Hotel, leaving the runners' remaining gear at the Inter-Tir (**When the Smoke Clears**, p. 32).

3:00 A.M. GMT: MacSweeney secretly tips off the Garda to the shoot-out at Altan Lodge and the supposed involvement of the runners. At this point, the government monitors begin to pay particular attention to international and long-distance phone calls out of Connaught (**When the Smoke Clears**, p. 32).

3:15 A.M. GMT: Garda teams reach Altan Lodge (**When the Smoke Clears**, p. 32). TRC computers note shooting at Altan Lodge (**Red Haze**, p. 42).

- 3:20 A.M. GMT:** With the identification of INLA members involved in the Altan raid, including the runners, the Garda officially notifies the TRC (**When the Smoke Clears**, p. 32).
- 3:25 A.M. GMT:** TRC computers note involvement of the INLA, including the runners, at Altan Lodge incident. Identification of runners as terrorists attributed to "anonymous source" (**Red Haze**, p. 42).
- 3:30 A.M. GMT:** Garda computer systems within 90 kilometers of Altan Lodge contain information about the raid on the manor (**Red Haze**, p. 42).
- 3:55 A.M. GMT:** TRC computers note the retrieval of the body of a member of the Irish Mafia from Altan Lodge (**Red Haze**, p. 42).
- 4:00 A.M. GMT:** Warrants are issued for the runners' arrest, and the TRC begin actively hunting them down (**When the Smoke Clears**, p. 32; also **Green Heat**, p. 48).
- 6:00 A.M. GMT:** MacSweeney arrives at Shannon airport. Authorities begin monitoring calls out of the Tír (**When the Smoke Clears**, p. 32). Garda computer systems outside of Connaught receive information on the raid at Altan Lodge (**Red Haze**, p. 42).
- 6:25 A.M. GMT:** MacSweeney reaches Boyle Abbey (**Plants with Attitude**, p. 52).
- 7:00 A.M. GMT:** Garda team reaches McDonnell residence during sweep of the area (**Night Stalkers**, p. 40). Also, MacSweeney's helicopter departs the airport for Boyle Abbey to pick him up (**Red Haze**, p. 42).
- 9:30 A.M. GMT:** Banks open. If the runners are trying to get big loans from NPCs to get themselves out of trouble, they cannot do so before 9:30 a.m.

DOWNTIME IN DUBLIN

Both the gamemaster's and players' copies of MacNamara's itinerary, provided above and as a Player Handout, respectively, include free time for the player characters during the first two days MacNamara spends in Dublin before the trip to the John F. Kennedy Memorial Park. Though the following text deals with Dublin only, the players may improvise one or two of the suggested encounters in the park setting. During the player characters' time in Dublin, they experience only one scripted encounter: **Dark Blue Eyes**, p. 25. The rest of their time is spent either following MacNamara around at public events or amusing themselves when off-duty. In both of these cases, improvised encounters can take place. The following sections describe for the gamemaster the specific types of encounters most likely to occur when the runners are on duty and off.

Though the runners need not be "on-the-job" at every waking moment, they must perform the specific task for which they were hired. This means that they must be where the itinerary requires them to be at the prescribed time. At all times, they must act like professionals, avoiding such behavior beloved of runners as barroom brawls or illicit activities of any kind. Any breach of professional conduct results in a 10-percent pay cut. Rosenberg and even Wassall would be more than happy to penalize any runner who thinks he has come to Tír na nÓg to have a good time at MacNamara's expense.

PUBLIC EVENTS

For those public engagements where the runners must accompany MacNamara but no encounters are scripted, the gamemaster may embellish these events using background infor-

mation from the **Tír na nÓg** sourcebook to give the runners a feel for the sights and sounds of Dublin. Such embellishment may help to draw the runners into exploits of their own during their free time. If he desires, the gamemaster should feel free to spice up a public engagement with a minor skirmish of some kind. These skirmishes allow the runners to look good in front of their employers by alerting MacNamara's security if they see trouble coming, and also make the encounter in **Dark Blue Eyes** less obviously an arranged event. Following are a few examples of curves the gamemaster might throw at the runners during public events.

Liptons

This infamous group of theatrical anarchists, guerrilla poets, and general mayhem-raisers enjoys disrupting public events with impromptu street theatre. Though non-violent, the Liptons can ruin the most carefully planned public-relations gimmick. Use the game statistics of the Squatter contact (p. 210, **SRII**) for members of the Liptons.

Metahuman Rights Activists

A small group of trolls, orks, dwarfs or humans may mount a protest at any time. A demonstration outside Bloduedd's Night Club during MacNamara's visit would be especially appropriate, because this place generally refuses to admit non-elves. The Garda and TRC deal harshly with these protesters, who carry few weapons and at least initially remain peaceful. Use the Metahuman Rights Activist contact (p. 209, **SRII**) for human activists, and any suitable metahuman contacts for the rest (Dwarf Technician, Troll Bouncer, Squatter with appropriate racial adjustments to Attributes, and so on).

Celtic Purists

A peaceful protest by Celtic purists is easy to stage at any scheduled cultural event. In their Celtic regalia, they look fairly normal by Tír na nÓg standards and are difficult to spot until they start causing trouble. They berate government officials for failing to pursue "true" Celtic standards in the cultural laws of the Tír (see p. 44, **Tír na nÓg**). Polite and peaceful, they can bore anyone willing to listen into a stupor ("Let me tell you about the correct methods for authentic pre-Christian Celtic basket-weaving..."). The gamemaster may use almost any "ordinary folk" contact from the **Contacts** book (**SRII Gamemaster's Screen**) for game statistics: Pedestrian, Store Owner, Technician, or Taxi Driver (known locally as the dreaded Dublin cabbie).

Anti-American Demonstration

In an ironic reversal of historical trends, money from UCAS Protestants supports Ulster Protestant terrorists as Catholic contributions once supported the IRA. Although the amounts remain quite small compared to British support for the Ulster terrorists, some Tír residents (especially those whose relatives have been blown up by the NURM or some other group) hold demonstrations to protest American funding of these organized killers. The demonstrations typically comprise sign-waving and slogan-shouting, a couple of shots fired into the air from improvised weapons, and the odd petrol bomb to get attention. The runners easily spot and head off any such demonstration in the making, though they may get involved in a brawl if the protesters recognize them as Yanks. The gamemaster may use any contacts or archetypes he sees fit for game statistics, but should keep their weapons minimal. Nine times out of ten, these demonstrations are more bark than bite.

Dealing with Tir Security

Public events always attract large crowds, for which the Garda and TRC provide security in addition to MacNamara's personal bodyguards. The runners know what the Garda and TRC officers look like (see **Kiss the Tarmac**, p. 117; also p. 40, **Tir na nÓg**). A cordon of Garda officers keeps crowds and observers away from the entrances to museums, hotels, and other locations that MacNamara visits, and lines roadsides while he does his handwaving act from his limo. Garda officers carry concealed pistols under their jackets, but maintain a visible presence. TRC troopers are much less visible, stationing themselves in vans on street corners, down alleyways, or in rooms overlooking important locations. They deploy rapidly if needed, but remain hidden unless a threat arises that the Garda cannot handle.

At any sign of trouble, the runners alert Rosenberg using their wristphones. He then radios the runners to discuss the threat while MacNamara's bodyguards cluster closer around the candidate and whisk him to a safer location. If the Garda have not already spotted the threat, Rosenberg alerts them. If Rosenberg decides the threat is slight, he suggests the runners continue surveillance and keep him informed. The runners are under orders not to initiate direct action, though they can earn a brownie point or two by helping a beset Garda policeman in a minor fracas. For a Garda officer's game statistics, use the Street Cop Contact (p. 211, **SR11**). TRC trooper game statistics are provided in **Green Heat**, p. 48.

FREE TIME

During certain non-public functions where TRC and Garda security are taking care of business, the runners' presence is neither needed nor desired. These events are noted on the itinerary; while they are going on, the runners are free to amuse themselves as they wish, though Wassall warns them not to do anything bimble-brained. The runners can take Wassall's advice and stay in their hotel rooms, but most likely will choose to go out and about. The following text suggests activities the runners may wish to pursue and the encounters they may generate.

Legwork

In the Tir and with the tour itinerary in hand, the runners may do some extra research. For example, they might scan public datanets, newspapers, and other information sources, or place a few calls back home to chase down contacts. **Legwork**, p. 61, provides likely sources and contacts for this research. The gamemaster should also feel free to create other information sources from the locations and people described in the **Tir na nÓg** sourcebook.

If the runners place or receive more than four phone calls from outside the Tir in any 24-hour period, add 1 to the visible action tally. By spending 1 Karma Point, however, the runners can make 8 calls in a day before the action draws attention from the authorities.

Tourist Trip

Dublin offers the tourist plenty of delicious food, fine ale, and beautiful women. If the runners decide to don their Hawaiian shirts and seek out the tourist action, give them the tourist map (p. 75) to use as a starting point. They need not limit their extracurricular explorations to the sites on the map. If they wish, they may seek advice on where to go from locals on the streets or from a Dublin



taxi driver. One or more NPCs may even decide to show the runners the sights (see **Dark Blue Eyes**, p. 25). Dublin sites such as the Zoological Gardens, Plunkett's Toy Shop, or Sharkey's Fine Books described in the **Tir na nÓg** sourcebook can provide a basis for encounters while sightseeing.

If the runners just want to scarf boxty, swallow oysters, and knock back pints of Guinness, fine. However, the gamemaster may feel free to embroil them in a short mini-encounter or two if they seem uninclined to generate one themselves. Whatever the player characters choose to do, the gamemaster should try to stage at least one or two minor encounters to keep the runners on their toes and make their impending entrapment (**Terror in the Dark**, p. 27) less obvious. The following ideas may serve as starting points. The runners are foreigners, and their American (or whatever) accents are very noticeable in Dublin. Also, ordinary Dubliners do not carry firearms. Walking around with obvious weapons certainly attracts the attention of the Garda and counts as a visible action. Keep in mind, however, that a fracas in every place the runners walk into is implausible and inappropriate. For further guidelines, see **Debugging**, p. 24.

Yankee Go Home

In this variation of the anti-American demonstration described earlier in this section, the runners walk into the middle of an activist group's back-room meeting. Unless they can talk themselves out of trouble by condemning Prod terrorists, claiming they have impeccable Catholic ancestry from Galway, and so on, a melee could erupt.



Did You See My Hamlet?

In a small pub, an aging and unemployed elven actor with the gift of the blarney and an unquenchable thirst for Guinness regales the runners with tales of his theatrical exploits and the wickedness of Tir cultural laws (see p. 44, *Tír na nÓg*). This contact can fill in some of the more obscure details of Tir cultural life for the runners. The gamemaster can also name him Cormac Roche, a member of the Roche Danaan-mór Family of Munster, who might know a few interesting personal facts about the powerful O'Tooles (see *Leg-work*, p. 61). Cormac Roche can certainly provide scandalous details of the private lives of the O'Toole daughters.

Media Hit

Minding their own business over a pint, the runners are corralled by a reporter for Radio-Trideo Éireann-Tír (RTET), the national broadcasting company. The reporter is asking people in the street what they think of Pat MacNamara's tour. When the reporter discovers the runners are Americans, she's overjoyed. "Now we can hear what the people back home in the UCAS think of Mr. MacNamara," she trills to the camera. In this situation, the runners must reply with care.

In another alternative, a reporter for *Inflame*, the underground cultural broadsheet, hears the runners' American accents and asks for info on up-and-coming entertainment wizzers across the Pond. Of course, the runners may not be aware that *Inflame* is a prohibited document under Tir cultural laws. When the Garda come calling midway through their informal interview, the runners will be mightily surprised.

I'm an American Too!

As the runners scarf down lunch, they encounter a single Seattle tourist who loves to meet folks from his home town. This guy is the type who buys tacky souvenirs everywhere he stops and constantly complains that he can't find a Nuke-It burger in the Tir. Give this NPC some resource that the runners might find extremely useful later on in the adventure, such as a contact, certain equipment, detailed knowledge of the Tir's transportation systems, and so on. By reading through the adventure, the gamemaster can create a resource that complements any weaknesses the runners may have. Make the NPC a drek-brain, weirdo, runner-wannabee, or anything else that may irk the runners without tempting them to dump him at the first opportunity.

OBSERVING MACNAMARA

One element of MacNamara's behavior should become apparent to the runners during his less public encounters (at the night club, and so on). A successful Psychology (Individual Behavior) (4) Test reveals MacNamara's patronizing attitude toward nonhumans, an ingrained trait that he tries hard to conceal. With important Tir elves he acts a bit too humble and admiring, but tends to act offhand with any less important nonhuman in a way he does not with comparable humans. The runners' observation of this trait becomes important in any dénouement with Nathair MacSweeney that may occur at the end of this adventure.

DEBUGGING

Though the runners' medical insurance is equal or even superior to DocWagon™ Platinum coverage, all hospitals in Tir na nÓg are state-run. If the runners are badly injured in a brawl, the authorities know about it and the runners' visible action tally gets higher. However, this situation only becomes a problem if the runners get unreasonably violent during their improvised encounters. If they choose to get into deep drek with the limited weapons that the Tir's stringent laws leave them, the gamemaster may deal with the violence in one of two ways.

If he wishes, he may allow the runners to escape from the scene of trouble before the Garda arrive. This does not mean allowing the runners to go unpunished; as foreigners, they are easily remembered and described by Tir citizens. If anyone witnesses the trouble, the authorities quickly suspect the runners and Wassall must smooth matters over. If this happens, Wassall gives the runners the mother of all bawlings-out and reduces their fee by 25 percent. Subtract 1 Karma Point from each runner involved in violent actions and add 4 to the team's visible action tally.

The gamemaster may also choose to have the runners arrested, meaning that Wassall must bail them out. In addition to cutting their fee and docking Karma Points from the runners responsible, add 6 to the team's visible actions tally. If the runners have been particularly drekbrained, confiscate their passports and schedule a court hearing for some time after their five-day stay. Either course of action allows the gamemaster to proceed with the adventure and throw the slots into the slammer afterward.

If the gamemaster chooses to leave the runners in the clink, go to **Picking Up the Pieces**, p. 59. In all other cases, the gamemaster should allow improvised encounters to proceed. Go to **Dark Blue Eyes**, following, at the point indicated in the itinerary. When the so-called business meeting at Altan Lodge in Glenveagh National Park occurs (Day 4), go to **Terror in the Dark**, p. 27.

DARK BLUE EYES

TELL IT TO THEM STRAIGHT

This encounter takes place on Day 2 at noon in the Flathall Hotel. The text assumes that the team has a hunky-looking male with high Charisma who draws the attention of Bridgit O'Toole. If the runner with the highest Charisma is female, then Bridgit's brother Padraic shows interest. In that case, the gamemaster must modify the following text and this encounter as a whole to reflect the change in gender.

Three hours of culture is more than enough. Still jet-lagged, you couldn't really appreciate the finer points of interest at the Natural History Museum, where MacNamara admired some fine relics of reputed ancient MacNamara family scions. Watching him press flesh and smile for the trid cameras, you nearly went snowblind from the reflections off MacNamara's perfect teeth. Now it's lunchtime, for which you thank the spirits. MacNamara's entourage and their glamorous guests, mostly elves, are swirling around the entourage's adjoining suites at the Flathall. All you have to do is keep an eye on things while you eat.

Just in case you missed it, Wassall pointed out to you the not-so-subtle social division among the guests. The aristocrats and other top-echelon folks spend most of their time in the James Joyce suite. This group includes MacNamara, Rosenberg, Ms. Brown, the Hispanic decker—what's his name, Almodovar?—and the egregious little "image analyst," Peter Lewis, who trails after MacNamara like a dog waiting for scraps at an aristocrat's dinner table. You're stuck in the Mary Margaret O'Hara Suite with the rest of the grunts: Wassall and a nervous, anorexic blonde who assists Anthea Brown. MacNamara's monosyllabic bodyguards hover by the doorway to keep the rest of you grunts from going to the bigwig suite next door.

A drekload of elves decked out in serious ritual regalia hang out with the important crowd in the Jimmy Joyce rooms. The O'Tooles are there in force, including the grizzled elven patriarch Seamus, who looks old even for an elf. Other prominent elves include Byrnes, O'Briens, and even an O'Connor or two. Most elves are easy on the eye, but the males among you can't help scanning lovely Bridgit O'Toole. A real elven vision in a silver gown, Bridgit has eyes of such a deep dark blue that you'd swear some angel brought the sky down from the heavens at dusk to make them. Can her tumbling cascade of auburn curls be real? Sighing, you look down at your drink. She's next door, hobnobbing with the other elven aristocracy, and you're just a humble grunt. To someone like her, you're part of the furniture.

A soft voice breathes into your left ear. "If I asked you to peel me a grape, would you do it?"

Bridgit O'Toole stands before you. She smiles innocently at you with the tiniest hint of mischief in her gorgeous eyes.

HOOKS

Conversation, clinking glasses, elegant clothes, and Bridgit (or Padraic) O'Toole. She's drop-dead gorgeous and she wants to get to know you, chummer.

BEHIND THE SCENES

A straightforward encounter, **Dark Blue Eyes** allows the runners to start developing contacts who may prove useful later on in the adventure. They can make two potential contacts: Bridgit or Padraic O'Toole, and Petra Johnson.

BRIDGIT/PADRAIC O'TOOLE

The young O'Tooles are too rich, too stylish, and too powerful. Life is easy for them. They will toy with the affections of a love-besotted runner for as long as the attention amuses them, though they both get easily bored by anyone who falls for them too fast. In fact, they get bored before long with anyone. Though bright at business, both exhibit a certain, charming naiveté. Neither is ruthless or truly malicious. For more background and game statistics, see **Cast of Shadows**, p. 68.

Bridgit's approach reflects her boredom. She and Daddy Seamus have been talking business all day with MacNamara, and Bridgit wants a little diversion. She has met few non-Europeans, and the runners interest her. Provided that a handsome male runner has something interesting to say about art, the media, crime, or just about any other subject, Bridgit stays a while, scoots back to the James Joyce suite, then returns a little later to talk more. After this first meeting, mostly confined to social pleasantries, Bridgit bestows a peck on the cheek of the object of her attention and leaves, saying that she will see him again at Bloduedd's that evening.

This encounter requires careful roleplaying. Bored with talking politics and business, Bridgit wants entertaining, amusing company. To determine how the runner impresses Bridgit, the gamemaster can either make a Charisma (6) Test or roleplay the encounter, testing the player's ability to put the moves on a high-class, elven lady. If the gamemaster opts for the Charisma (6) Test, 1 success creates a fair impression; 2 or more successes means that Bridgit likes the runner a lot. At this point, Bridgit refuses to tolerate a runner pumping her for relevant information; this tactic will only succeed after the events at Altan Lodge (see **When the Smoke Clears**, p. 27.)

PETRA JOHNSON

Petra feels neglected during lunch unless one of the runners makes a successful Perception (4) Test to notice her and then decides to speak with her. Petra believes that Anthea takes the credit for her work, and she feels unappreciated. Though this assumption is partly true, much of Petra's problem stems from her low Essence Rating and her chip habit. For the runners, Petra's mental instability is something of a double-edged sword. Though it makes her unreliable, it also leaves her vulnerable to the runners' attempts to glean information. If one or more of the runners acts nicely toward her, Petra may prove helpful later in the adventure. For example, if the runners ask her to join them on a trip around Dublin in their free time, she is quite flattered.

The gamemaster determines how hard the runners must work to establish this contact. If the runners keep making efforts to socialize with her, let Petra feed them bits of information about the MacNamara entourage as seems appropriate. At this stage, however, she knows nothing of real importance to the adventure storyline. Rather, the runners need her so that she can help them later on (see **When the Smoke Clears**, p. 27). For complete details and game statistics on Petra Johnson, see **Cast of Shadows**, p. 69.

DEVELOPING OTHER CONTACTS

During the rest of Day 2 and Day 3, the runners have a few planned activities and considerable free time in Dublin during which they can meet Petra and Bridgit (or Padraic) more than once. The friendships the runners develop through such social contact will become vital to their later survival, but may also attract unwanted attention. The runners can cultivate these relationships at the evening affair at Bloduedd's and during their free time. During these time periods, the runners must initiate actions to advance these relationships.

The runners need to gain Petra's trust and friendship and Bridgit's continued romantic interest. Petra wants companionship. Bridgit wants flowers, smooth talk, wit and style, and a little sense of danger from her man. For both NPCs, reward the player characters for creative courting. For example, if Bridgit's beau prepares for the evening at Bloduedd's Night Club by visiting the exclusive Brendan's Wine Shop at 22 Chancery Street for advice on the best vintages of an unusual champagne, she'll be much more impressed than if he brings her a diamond. (She has hundreds of *those*, and such a gift is a bit premature so early in a relationship.) Keep track of how creatively the runners woo Bridgit and Petra; though the runners do not know it, any brownie points earned now will prove valuable later.

However, if a male runner associates more than twice with Bridgit outside of Bloduedd's or the luncheon at the Flathail, Seamus notices and starts checking on the runner. In this case, the gamemaster should add 2 to the team's visible actions tally. A female runner taking up with Padraic does not commit a visible action, because Seamus is an old-fashioned elf; he keeps his daughters under tight rein, but lets his son do as he pleases.

Other NPCs in MacNamara's retinue are no use to the runners as contacts; they refuse to deal with the runners beyond social pleasantries.



PAPERS FOR THE MOB

At some point during lunch, O'Toole representatives provide documents to members of MacNamara's entourage that contain details and schematics of the O'Tooles' dock and cargo-transfer facilities at Rosslare Harbor. O'Toole is providing this sensitive information to MacNamara to demonstrate the company's capabilities for the New York transportation project under discussion. However, MacNamara secretly plans to supply information to the Irish Mafia connections in Tír na nÓg (**Terror in the Dark**, p. 27). Making the connection between the transfer of papers at the luncheon and the later appearance of the material at Altan Lodge may give the runners some immediate ammunition with which to save their own skins after that encounter.

DEBUGGING

The runners can only go wrong in this encounter by blowing it with Bridgit (or Padraic). If they do, tough. A runner who has survived a few shadowruns should be able to keep his cool when dealing with a goddess; if he can't, he deserves what he gets.

The runners may also fail to notice or make friends with Petra Johnson. If they do, stage an encounter with her during their free time: have them find her drinking her sorrows away in a Dublin pub or getting mugged in a back street. Once Petra has drawn their attention, the runners can develop her as a contact.

After Day 2 and 3 have passed, go to **Terror in the Dark**, p. 27. The action in that encounter moves out of Dublin, taking the runners away from Bridgit O'Toole. If the runner of her choice has impressed her enough in Dublin, she may travel down to Connaught and see a little more of her new squeeze. However, if the runner has not managed to get her telecom number by the time the team departs Dublin, the team will pay for his lack of initiative.

TERROR IN THE DARK

TELL IT TO THEM STRAIGHT

This encounter occurs on Day 4, after MacNamara's appearance at JFK Memorial Park. If developments from Dublin encounters might affect events during this day, the gamemaster should let the runners catch up with those and modify the following narrative as appropriate. Likewise, if the gamemaster stages a minor diversion at JFK Memorial Park, as suggested in *Don't Ask for Scotch*, he may amend this section as necessary. If the gamemaster prefers to use the text as a guideline for roleplaying the scene instead of as a narrative, he must orchestrate the sequence so that the scene reaches the same conclusion. Use game statistics for *Street Samurai* and *Mercenary* archetypes, pp. 58 and 62 of SRII, for the terrorist attackers.

Your nerves have been on edge all day as MacNamara strolled around the Kennedy Memorial Park, but nothing untoward happened. This job's nuyen for nothing, all right. You've got some time before you have to prowl around the Inter-Tir Hotel dining suite, and you figure on looking for some of that renowned Tir seafood down in the grunt's diner. You'll be back home eating the usual synthetic drek soon enough; might as well enjoy high living while you can.

A buzz from the hotel telecomm sends you to MacSweeney's room. It's already full of bodies. Wassall, Rosenberg, and half of MacSweeney's bodyguards are standing around, wearing overcoats and holding shiny briefcases. Obviously, they're going somewhere.

The elf barely acknowledges you as you enter. "Change of itinerary," he explains tersely. "Some of the Connaught people prefer not to make a trip here this evening, so we have to go to them. Two choppers are waiting at the airport helipads, and we need to get there by eight." He looks irritably at his watch. "You people come with me in the first limo. We'll take the first chopper," he says, his arm tracing an arc that includes just over half of your group. "Rest of you, take the second car. Let's go."

As the others file out past you, MacSweeney strides over. Out of the corner of your eye, you think you see Rosenberg lurking down the corridor. "Look, I'm sorry about this," the elf says. "I didn't know about this trip myself until an hour or so ago. We have to meet some business specialists at Altan Lodge in Glenveagh National Park, County Donegal. We wanted to meet them here at the hotel, but they refuse to leave their greenleaf paradise, so we have to go to them." He grins. "I prefer cities myself. Anyway, we have a few minutes, so grab anything you may need. We should get back to Shannon tonight, but the weather reports predict fog

along the coast, so we may not get back until tomorrow. See you in the car park."

MacSweeney says little during the helo ride, but at least the Hughes Stallion chopper is comfortable and fast. The helo cuts through a fog bank to land on a large, circular swath of green lit by floodlights. A grand old Irish mansion sits less than ninety meters away.

Rosenberg, MacSweeney, Wassall, and a couple of bodyguards make for the west wing of the building. Keeping watch in the central hall as ordered, you catch a glimpse of the businessmen. You feel as if you're watching a spy fashion parade; every one of them is tall and dark, wearing a long overcoat and carrying a top-of-the-line security briefcase. Cyber-enhanced troll bodyguards follow in each one's wake. Everyone smiles with the same transparent lack of sincerity, but nobody acts particularly threatening. Some business meeting, but it's not your place to wonder much about your source of nuyen.

An hour crawls by, without a sound from the meeting room. Nothing's happening outside, either. You're almost tempted to lie back and catch forty winks, but if MacSweeney or Wassall or (spirits forbid) that slot Rosenberg come out unexpectedly and catch you, they'll dock your pay. Instead of napping, you amuse yourself by wondering how much each piece of antique furniture in the hall costs.

Suddenly a mortar round rips into the west wing and all hell breaks loose. As the lights in the house and floods outside blink out, you hear all kinds of rounds screaming through the air. High-explosive missiles, grenades, APDs, all flying through the night straight toward where you stand.

Through the smoky haze, you spot a few figures running from the west wing of the mansion. Among them you recognize MacSweeney by his height, followed by Rosenberg and a couple of the "businessmen" with a troll or two in tow. The trogs' Uzis are blazing as the group runs for the choppers. You follow suit; this place ain't healthy anymore. As you take cover behind the statues in the garden, still too many meters shy of the choppers, MacSweeney turns toward you.

"Traitors! Only you knew!" he shouts as the trogs bundle him into the nearest chopper. You have no time to protest your innocence; you've got to make that second helo before it takes off and leaves you stranded. A couple of runners from your team unload their pistols against the hail of incoming fire peppering the west wing, for all the good that will do you. Just as you sprint for the second chopper, the fraggin' thing explodes in a huge ball of flame. Those of you not briefly blinded by the fiery blast see a handful of shadowy figures moving in the fog, behind the trees south of you. They look like they're packing wiz heavy weapons, and they're heading your way.



BEHIND THE SCENES

A great deal has happened behind the scenes in this encounter. First, Rosenberg has supplied technical details of O'Toole Transcom systems to the representatives of the nascent Irish branch of the Mafia, who want to infiltrate O'Toole Transcom in order to smuggle BTL chips into the Tír. This information represents only part of the payoff the Mafia plans to extort from MacNamara for its silence about his past. Unknown to everyone else, MacSweeney has informed members of the terrorist Irish National Liberation Army (INLA) about the meeting, knowing that the INLA will sabotage it to prevent the Mafia from muscling in on the INLA's criminal empire in the south of the country. In return for the tip-off, the INLA instructed its operatives to leave one of the choppers intact, and not to fire at any elf until the surviving chopper had taken off. Rosenberg, MacSweeney, all but one of the important Mafia men, and a couple of grunts escape safely, leaving the other grunts and the runners to take the flak. MacSweeney deliberately told the runners the meeting's location so that he could pin the security breach on them.

Once the destruction of the chopper cuts off the runners' escape route, the runners have three options. They can head out the front door and try to fight the INLA men approaching from the south, retreat out the back of the mansion, or head to the west wing to look for clues. If the runners contemplate a suicidal battle with the INLA, or simply hope to remain in their current positions and trade pistol shots with mortars and heavy weapons, inform them that they will likely die. If they persist, let them have it. The map of the lodge grounds below shows the placement of the INLA terrorists, who are grouped into three four-man cells. If the runners survive such a frontal attack, let them obtain some weapons from the terrorists to even the odds for the few of them who are still alive.

If the runners retreat into the hall and out the back door of the mansion, they run straight into an INLA cell. A mage may prove vital to the runners' survival in this case; a well-targeted spell will likely enable them to escape immediate death. If they manage to overwhelm the INLA men, they can take the terrorists' weapons.

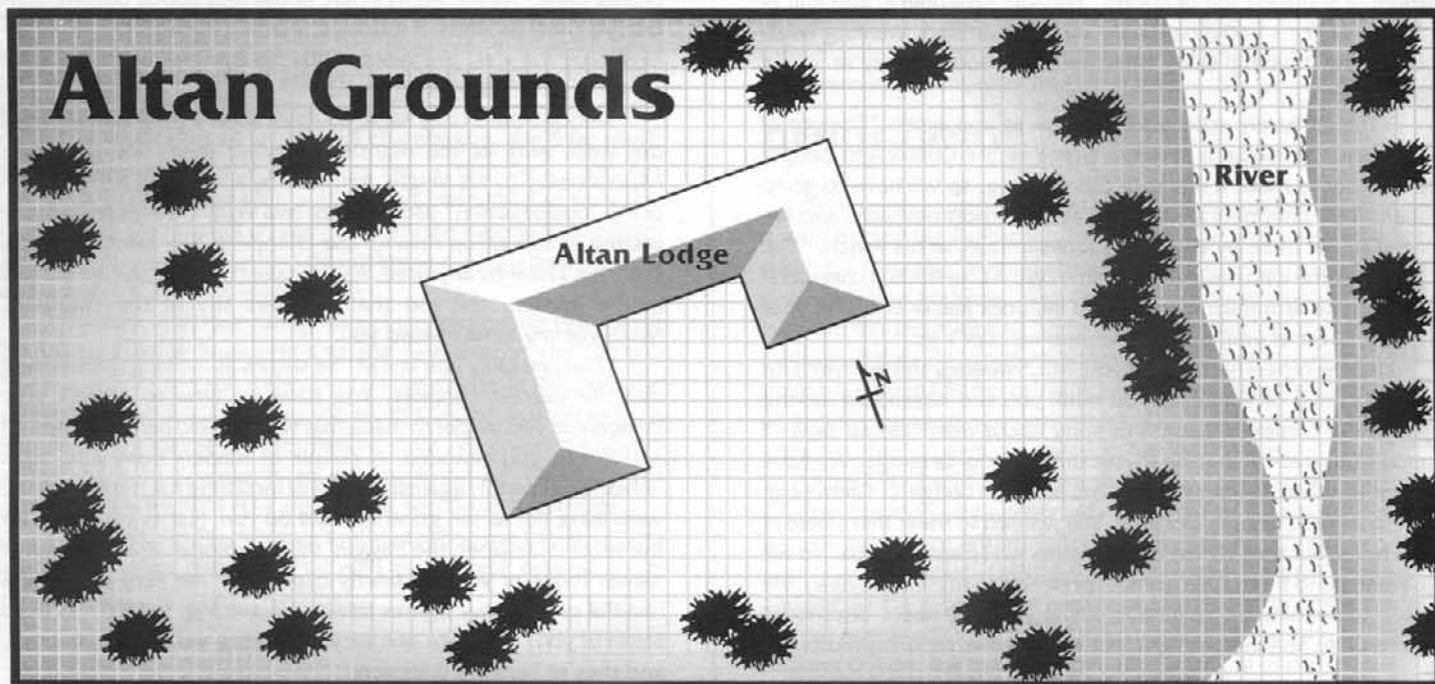

The runners may choose to head for the meeting room in the west wing to search for clues about the attack or anything else that might help them survive (see **Meeting Room**, below). At some point during their search, a mortar round hits the west wall and causes 4M (Stun) damage to any runner in the room. The team should take this as a cue to move on. Exiting out the front door remains a suicidal option; the runners might prefer to leave by the back door.

If the runners try to enlist the aid of the few surviving bodyguards in their escape, either Mob trolls or MacNamara's men, these NPCs refuse. They heard MacSweeney's parting yell and don't trust the runners an inch. The gamemaster may wish to have a couple of these NPCs make a dash for safety out the front door and get blown to pulp, in order to show the runners the folly of such an escape strategy.

TERRORISTS (12)

B	Q	S	C	I	W	E	R	Armor
3	6	3	4	4	4	5.5	5	6/4

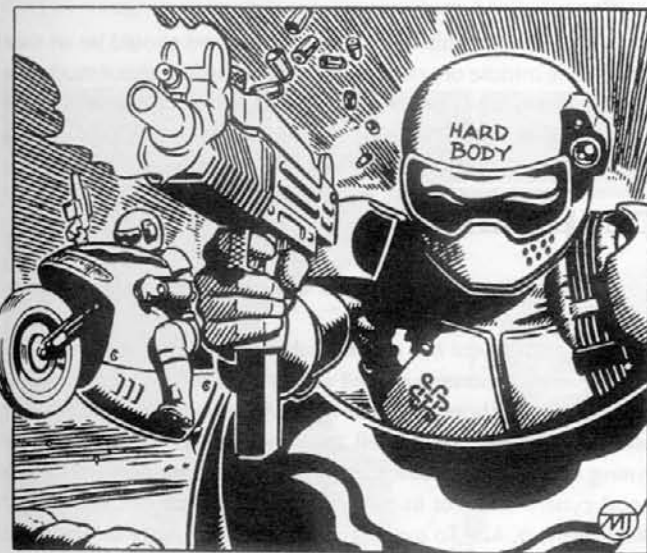

Initiative: 5 + 1D6

Threat/Professional Rating: 4/4

Skills: Armed Combat 4, Bike 3, Car 2, Demolition 3, Firearms 6, Psychology 2, Stealth 4, Unarmed Combat 4. One member of each four-man cell also has Gunnery 4.

Cyberware: Smartlink

Gear: Ares Predator [Heavy Pistol, 15 (clip), SA, 9M] or Remington Roomsweeper [Heavy Pistol, 8 (magazine), SA, 9S (f)], Partial Suit of Heavy Armor (6/4), Uzi III [SMG, 24 (clip), BF, 6M, Internal Smartlink]. Each four-man terrorist cell also has 4 High-Explosive Missiles and a Multi-Launcher [4(b), 55].

Notes: All INLA terrorists are under the influence of "Kamikaze," a designer drug that adds the following to Attributes and Initiative: +1 Body, +1 Quickness, +2 Strength, +1 Willpower, and +1D6 Initiative. Record damage in four boxes on each terrorist's Condition Monitor for the drug's 30-minute duration, using any combination of Stun or Physical damage. Also, each terrorist rides a

Hyundai Offroader (game statistics follow). An entire page of condition monitors for the terrorists has been provided in the back of this book.

The INLA men are determined, fanatical psychopaths. If the runners somehow manage to capture one or more alive, they reveal nothing voluntarily. If magically compelled to speak by a mind probe spell or the like, they know little of any use. They received anonymous orders from a cell commander using passwords at their base in Enniskillen about an hour before the meeting started, meaning that their informant could have acquired the information about the meeting after MacSweeney briefed the runners. The INLA men do not know who ordered the attack, or why, or where the command came from. However, if the runners ask the right question under compulsion (unlikely) the terrorists might reveal their orders not to fire at the escaping chopper or at any elf until the chopper lifted off. This information should certainly interest the runners.

If the runners manage to retrieve any of the terrorists' gear, the following rules apply. For any pistol, the runners also retrieve 4D6 rounds; for any Uzi, 3D6 rounds. Roll 1D6 to determine damage to any captured motorcycle. On a roll of 1-3, the bike is fully operational. On a roll of 4, the bike has taken Light damage; 5, Moderate damage; 6, Serious damage. If the runners retrieve a multi-launcher, however, it does them no good. The cell has just run out of HEMs, and the terrorists have used up their grenades.

Hyundai Offroader

Handling	Speed	B/A	Signature	A Pilot	Cost
4/2	60/180*	2/0	2	1	12,500¥

Seating: 1 + 1*

Economy: 90 km per liter

Fuel: MultiF/25 liters

Storage: 2 CF underseat

*Sidecar can be mounted only if special option package is installed at a cost of 1,500¥. Off-road Speed is 55/165.

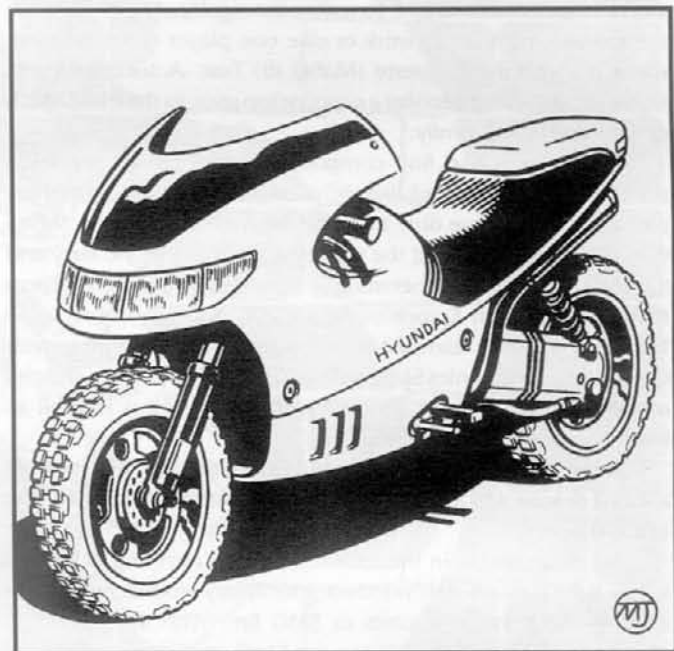

Altan Lodge

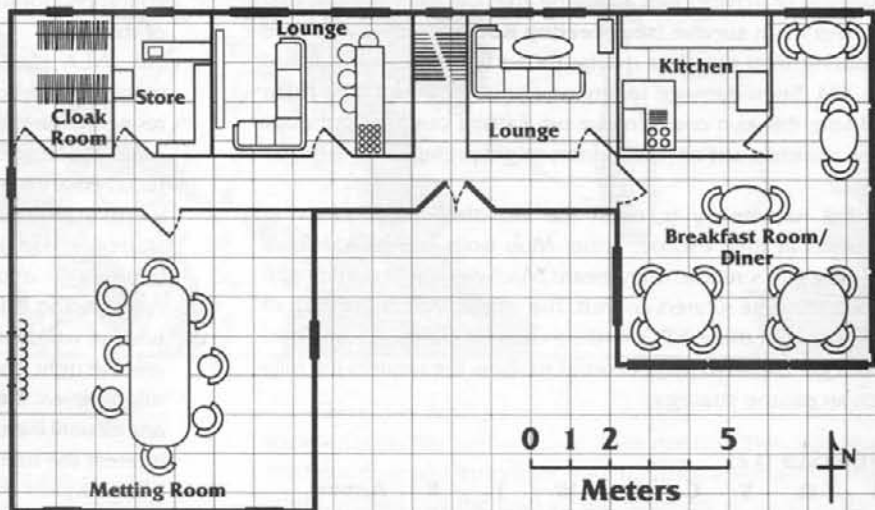

MEETING ROOM

In the west wing meeting room the runners find three dead bodies: one of the trolls, one of MacNamara's bodyguards, and one of the Irish Mafia members. MacNamara's bodyguard clutches a Remington Roomsweeper with three shots left in the clip, plus a full spare clip. The troll holds an Uzi III with 14 shots left in the clip and a full spare clip. The Mafia slot grips an Ares Predator with two full clips, as well as a money clip with £2,500 in £50 bills. (For weapons statistics, see p. 254, **SR11**.) The runners notice the weapons right away, but must search the bodies to find the spare ammo clips and money. At the gamemaster's discretion, the runners may also find other, trivial possessions such as small amounts of extra cash, wristwatches, and so on, but no IDs. The Mafia man wears a gold signet ring capped with an onyx raven with a single, diamond eye. To realize the significance of this item, the runners must do legwork or else one player character must make a successful Etiquette (Mafia) (8) Test. A successful test reveals that the ring denotes a capo, or top man, in the Irish branch of the Gambaccini family.

The runners also find computer printout sheets scattered across the table. They look like technical plans, though the runners probably do not have time to study them at the moment. When they do, they realize that the printouts are plans of the ferry and internal communication networks at Rosslare, the southern Tír port that handles much European ferry traffic. The logo of O'Toole Transcom is clearly stamped on the documents. Any runner with Computer or Electronics Skill can tell that the plans contain sketchy details, but clearly mark security and customs sites as well as hidden surveillance positions.

If any runner makes a successful Perception (5) Test, he finds a wallet dropped by a fleeing mobster. The wallet contains £6,000 in £100 notes.

No other rooms in the mansion contain anything of importance; if the runners start wandering aimlessly around, feel free to send in more mortar rounds or SMG fire. With the building's electricity shot to hell, the runners can hardly make any meticulous search.

At the end of this encounter, the runners should be on their own, in the middle of a national woodland park, without much idea of what the frag has happened. The INLA men disappear into the night on their bikes, leaving the runners alone at the site of a pitched assault and battle-strewn with corpses.

DEBUGGING

Quite a lot can go wrong in this encounter, so have contingency plans ready.

The equipment the runners take with them is important, for subsequent encounters as well as this one, because they may not get back to their hotel any time soon. Assume they are taking their usual armor, weapons, spell foci, and so on, which they wear during all their surveillance assignments. The runners will need a good cyberdeck later in the adventure to crack the TRC system (**Red Haze**, p. 42). To avoid giving away too much too soon, the gamemaster should not directly ask the team's decker if he is bringing his deck to the manor house. Instead, the gamemaster should either assume the decker has his deck or decide that he left it at the hotel because he would not normally risk it for such a trip. If the deck is left behind, the runners may be able to retrieve it through Petra Johnson (**When the Smoke Clears**, p. 32).

The runners may refuse to go to the meeting, though this is unlikely. So far, their assignments have been null perspiration, and MacSweeney lulls them into a false sense of security by telling them exactly where they are going. If the runners pump him for more information, MacSweeney acts annoyed but says, "Look, I can't give full details; these discussions are sensitive. I can tell you that we're dealing with reclusive folks who aren't prepared to leave their little country home. They have some important ideas on urban renewal and regeneration programs, mostly concerned with re-greening cities. That's why I'm going instead of Mr. MacNamara; they'll appreciate seeing an elven face, and will be more inclined to work with us." If the runners have noticed MacNamara's patronizing attitude toward nonhumans (see **Don't Ask for Scotch**,

p. 19), this explanation rings true. If the runners dig in their heels, Wassall threatens to withhold their pay and send them packing. If necessary the gamemaster should feel free to strong-arm the runners into going.

The runners may want to leave someone outside the mansion, to use surveillance techniques such as magical assensing, and so on. To get the runners to stay inside where he wants them, MacSweeney explains that the "businessmen" are a little paranoid about the runners roaming freely around the grounds. They prefer everyone inside, keeping an eye on each other. If a runner trots outside anyway and detects the INLA men approaching, assume that the motorcycle-riding INLA slots are fast enough to give the runners no more than a little advance warning. Of course, their first duty is to alert their employers.

If the runners decide to use magical surveillance, such as watchers and the like, the gamemaster can counter this in two ways. Either MacSweeney says he will take care of this and posts watchers as decoration, or the INLA contingent includes a mage who successfully dispels the watchers but leaves before the main action. Such a person would be much too valuable to risk in combat, though he may well cast a few Increase Attribute spells on

his colleagues before they start the fireworks.

The runners must face opposition large enough to force their retreat here; if necessary, the gamemaster may add an extra INLA cell or two to ensure that this happens. If an initial alert gives the runners an edge, increase the odds against them. However, keep in mind that they must escape. The fog helps them; treat as Light Fog for its effects on various forms of vision (see p. 89, SR11).

The encounter also allows Rosenberg, MacSweeney, most of the mobsters, and a handful of grunts to get away. The runners may smell a rat and try taking potshots at their escaping employers. They have only pistols, so they should not pose a real threat. However, MacSweeney's importance to the rest of the adventure allows the gamemaster to fudge any Resistance Tests the NPCs must make if the runners hit them. In addition, MacSweeney can use magical abilities to defend the escapees. No matter what the runners try, MacSweeney and company get away clean.

Finally, the runners may get themselves blown into small bits by rushing the INLA men out in front of the mansion. If they do so despite a warning, well, that's tragic. Of course, the Tír authorities will make sure they get a funeral.



WHEN THE SMOKE CLEARS



As with **Don't Ask for Scotch**, p. 19, this section is not a standard **Shadowrun** encounter. Intended as a resource section for the gamemaster, **When the Smoke Clears** includes information on several courses of action the runners may take that will lead them to subsequent encounters, as well as letting the gamemaster know what is happening with MacNamara's entourage back in Shannon. These offstage events will affect the players in some of the encounters that follow.

The gamemaster must keep careful track of time from this point on, paying especially close attention to the events behind the scenes on Days 4 and 5 of the itinerary (**Don't Ask for Scotch**, p. 20). Those events will have implications for the runners in the encounters following this section. The gamemaster should assume that the firefight at Altan Lodge takes place around 9 p.m., and keep track of increases in the team's visible action tally as well as elapsing time. Keep in mind that time may pass between the occurrence of a visible action and its recording in the tally; for example, the authorities take some time to process a phone tap.

GETTING MOBILE

Not knowing how much time they have before the police or security forces arrive, the runners need to get moving away from Altan Lodge. Not only must they keep one jump ahead of Tír law enforcement, they must also start investigating the attack immediately. The phones in the mansion are out of commission, so if the runners want to ring up contacts back home they have to find a vidphone somewhere else. They may also want to reach Petra Johnson and Bridgit O'Toole, their only real contacts in the Tír. As far as the runners know, Bridgit is back in Dublin and Petra is at the Inter-Tír Hotel near Shannon Airport. If the team's decker left his cyberdeck at the hotel, the runners may want to retrieve it; a little decking could go a long way toward getting the team out of deep drek. The runners may have retrieved a bike or two from the terrorists, but several runners probably will not have transportation. If the runners do manage to scrounge enough vehicles to move as a group, the gamemaster should simply change the details of later encounters to account for the runners' increased mobility.

Wherever they choose to go, the runners will almost certainly have to walk several kilometers through thick forest, on a foggy night, listening to the wails and howls of the paranimals that lurk in the forest's depths. If he wishes, the gamemaster may put their nerves on edge by springing an encounter on them (see **Night Stalkers**, p. 40). The runners can make for any nearby village listed on the map (**Player Handouts**, p. 75), such as Creeslough, Dunfanaghy, Gort an Choircre, Meenacung, and so on, where they can find transport and figure out where they are. Alternatively, they may head for the main road (N56) and hitchhike or commandeer a passing vehicle. The R251 has virtually no traffic, and so heading that way gets them nothing but sore feet.

Finding out exactly where they are should be easy for the runners. If they do not have a detailed map of Tír na nÓg, they can call one up from the treuntas public database (see p. 18, **Tír na nÓg**). They know that they were dispatched to Altan Lodge, and from that information they can map their present location. Of course, they may need to jack into the Matrix to do this and risk attracting unwelcome attention (see **Red Haze**, p. 42).

OUT OF YOUR CAR, CHUMMER!

Snatching a car is null perspiration for the runners. A body or a few tree limbs serve as a road block, and the runners take it from there. After 1D3 hours (roll 1D6 and halve the number, rounding fractions up), the gamemaster may decide to have an old jalopy come along. Use statistics for a Chrysler-Nissan Jackrabbit (p. 264, **SRII**) for this vehicle, modified to reflect the car's dilapidated condition. If he wishes, the gamemaster can spring a paranimal encounter on the runners during the waiting time (**Night Stalkers**, p. 40), or even have the TRC arrive at Altan Lodge if enough time

has elapsed (**Green Heat**, p. 48). He might even have a farmer amble down the road herding a couple of hundred sheep, and then let another 1D3 hours elapse before a usable automobile passes by. If the runners wave their guns to stop a car, the driver gets out at once and surrenders his wheels. Obviously, the runners need to gag and bind the driver and dump him in the forest to prevent him from raising an alarm. After 2D6 hours, the poor slot's wife reports him missing and the police broadcast an alert for the vehicle. If the runners are still using the car after that time, add 2 to the team's visible action tally.

WHEELS FOR HIRE

Instead of stealing transport, the runners may try hiring it. However, the runners cannot hire an automobile at any of the local villages; these burgs are too small to support an Avis Rent-A-Car outlet, though village garages do sell petrol. The runners can either hire a taxi to take them to a larger town where they can hire a car, or buy one of the villagers' cars. If they opt for the taxi ride, Letterkenny is the nearest large town they can get to. In Letterkenny, the runners can buy a car at the standard price for any given car in the **Rigger Black Book** plus 33 percent in taxes, provided one of the runners has an ID and an international driver's license. They can do the same in the more distant towns of Ballyshannon or Strabane, provided they can afford the astronomical cab fare. If the runners hijack a taxi, it is reported missing after 1 hour and the police are alerted at once; add 3 to the team's visible action tally. If a police alert has been raised, any car purchase is traced 1D3 hours after the original alert was made. Add 3 to the group's visible action tally if they still have the auto after this time.

If the runners choose to buy a car from one of the villagers, the handful of car owners in the village each demand 80 percent of the standard price for a beat-up Chrysler-Nissan Jackrabbit. A successful Bargain (4) Test reduces the cost to 70 percent of the standard price. The gamemaster may degrade the car's statistics as he sees fit.

The runners may also acquire transportation with the aid of Bridgit O'Toole. See **Other Necessities**, p. 37 of this section.

DESTINATIONS

The runners will almost certainly want to get away from the immediate area of Altan Lodge and find a town or village where they can plug into the Matrix, buy food, make phone calls, and so on. The gamemaster should not need a map of the town the runners pick; all rural towns in Tír na nÓg are pretty much alike. If the authorities track them down (**Green Heat**, p. 48), the gamemaster should use the Location Archetype of his choice from **Sprawl Sites** for that encounter.

Equipment is available in towns or villages as the gamemaster sees fit, within the following guidelines. As a simple rule of thumb, the runners need licenses and permits for almost anything worthwhile. Heavy or sophisticated weapons, explosives, cybergear or cyberdecks are unavailable, and any attempt to purchase anything of this kind adds 1 to the group's visible action tally.

For making a long-distance trip by car, plane, or train, the runners have two realistic options. They can rejoin the MacNamara entourage at Shannon Airport, or return to the city of Dublin to contact Bridgit O'Toole. If they travel by rail or air, they have a six-hour grace period before the authorities apprehend them. Of course, because they do not know about this grace period, the runners will most likely choose to run around the countryside. If so,

the gamemaster should consult the Tír map provided at the back of the book.

Any attempt to reach the MacNamara entourage proves suicidal. Anticipating the runners' return, MacSweeney has watchers posted all over the place. He has told MacNamara the runners must have tipped off the INLA men to the meeting at Altan Lodge, and Almodovar runs Matrix checks on the runners that eventually turn up information planted by MacSweeney that links at least one of the runners with Tír terrorist organizations (see **Red Haze**, p. 42). As a result, MacNamara relocates to the Shannon Bridge Hotel at 2:30 a.m. for security reasons, leaving decoy watchers and guards at the Inter-Tír Hotel. As soon as these get any whiff of the runners, MacSweeney informs the authorities of events at Altan Lodge and supplies data incriminating the runners, including the false evidence of their terrorist connections. At that point, the authorities dispatch a heavy-duty TRC squad to the Inter-Tír to wait for the group, and another to hunt them down on the road. For details on the TRC opposition, see **Green Heat**, p. 48. At 6 a.m. MacSweeney leaves the hotel for Boyle Abbey, so between that hour and 8 a.m. MacNamara will not have MacSweeney's magical surveillance to protect him; however, all the bodyguards will still be present and well-armed.

If the runners acquire evidence of MacNamara's Mafia links, MacSweeney's betrayal of his employer, and other relevant facts in **Legwork**, p. 61, they may contact MacNamara and offer him a deal. If he gets them out of Tír na nÓg alive, they will suppress the Mafia dirt and tell MacNamara which of his own people double-crossed him. If this happens, go to **Political Gambit**, p. 50.

If the runners head for Dublin, they may be able to lie low, especially with Bridgit O'Toole's help. Without her aid, the runners' chances depend on the team's metatypes and the amount of trouble the runners got up to during their earlier stay in the city. Ork runners might find help in a pub with links to the Ork Resistance Movement, but this might also send the adventure into a wild spin. Generally, the runners should gain time to clear themselves and/or escape the Tír if they keep moving from one shabby hotel to another. Subtract 4 from the team's visible action tally if they reach Dublin and manage to lie low, *unless* they take Bridgit O'Toole up on her offer of a "safe house" (see **Other Necessities**, later in this section). If they choose this option and any runner has met with Bridgit on an occasion outside of the functions at the Flathail and Bloduedd's, add 2 to the group's visible action tally.

GETTING INFORMATION

Smart runners will start thinking fast about where they can acquire information about the attack. Potential information sources fall into two categories: those within Tír na nÓg and those outside the country.

The following sections and their relevant entries in **Legwork**, p. 61 are extensive. In some cases, information from one source builds on that supplied by another source. For example, if Bridgit O'Toole tells the runners that the Irish Mob is the only criminal organization likely to smuggle contraband through the port of Rosslare, the runners may then ask an American contact a specific question about Mafia involvement of any member of the MacNamara entourage. However, the runners only receive relevant information by asking that specific question. A general query about criminal connections will not elicit the information

they need. To determine what the runners can learn as the adventure progresses, the gamemaster should keep a careful record of the sources the runners use, the information they obtain, and the time at which they obtain it.

HUMMING WIRES

The runners may consider phoning friends and contacts back home who might be able to give them a little relevant information. Though they may have tried this tactic earlier in the adventure with no luck, at this point they have more to go on: the location of the terrorist raid, the importance of O'Toole Transcom to the mess they have landed in, MacSweeney's name, and so on. **Legwork**, p. 61, covers the information the runners may be able to acquire from sources outside the Tír. However, given Tír na nÓg's reputation as a secretive and authoritarian country, some contacts may prove reluctant to discuss confidential information over the vidphone lines. To reflect this reluctance, raise the target number for Etiquette Tests made when dealing with contacts, basing the increase on the sensitivity of the information requested and the manner in which the runners ask for it. Use the examples in the next column as guidelines:



A runner calls his contact back in Seattle with a request for general information, saying something like, "Can you find out anything interesting about a joker I've met here in Tír na nÓg, some slag called Nathair MacSweeney? He's some kind of top gun in Pat MacNamara's band of publicity-grabbers. Could mean good biz when I get back home, but I'd like to know a little more about him before I take his nuyen." Because the runner does not seem to be in trouble and has made a straightforward request, the gamemaster should raise the target number to 6.

A harried-sounding runner says something like the following to his contact in Seattle: "Look, chummer, I'm in deep drek here. This slag Pat MacNamara, the politico I've been bodyguarding, double-crossed me. I know he has some connection with some gun-packing jokers over here in Tír na nÓg. I need any help I can get finding out what's going down." Because the runner admits he is in real trouble with politically powerful people, and hints that criminality is involved, the gamemaster should raise the target number for such a request to 12.

Another down side to phoning overseas contacts is the inevitable delay. Unless the runners are asking for information so simple that they could probably get it by consulting a bulletin board, the contact needs time to check it out and get back to the runner. The contact takes anywhere from 1-20 hours to find the information, at the gamemaster's discretion. To determine the time lag randomly, roll 2D6 and add 1 to the result. The total is the number of hours the contact takes to do his job. The contact also demands that the runner call him or her back at a different number, probably a public telecom, at a predetermined time. If the runner tries to call the contact's usual number before then, he gets an answering machine. The gamemaster may choose to shorten the time lag by half if the runners double the fee for information.

Any overseas calls may also be traced by Tír authorities. After 3 a.m., when MacSweeney informs the police of the terrorist raid at Altan Lodge, all calls originating in Connaught and directed to the runners' home nation are checked. The authorities take one hour to process the traces; after that time, each call made by the team becomes a visible action. If the runners get out of Connaught before then, they earn some extra time. Unless the runners make a drek-load of calls from one location and trigger a routine alert, calls from the rest of the Tír are not processed until 6 a.m.

Certain information available from overseas contacts (see **Legwork**, p. 61) is particularly sensitive or valuable. Such information is identified as **Hot Information** in the **Legwork** section. When runners seek this information, raise the Target Number for Etiquette Tests to 8. To get a contact to part with this information requires that the runner call in every favor that contact owes him, and also that he make promises he'd best keep when he gets back

Stateside ("Chummer, tell me something I need to hear and I'll give you my best spell focus/hot new simporn program/little black book/spare kidney for transplant"). At the gamemaster's discretion, the runners may also spend Karma Points to get this information at a rate of 1 point per item. However, the runner who does this loses these points permanently. Though a runner may use his Karma Pool per standard **SR II** rules, the gamemaster should treat the entire sequence of attempts to get information from foreign contacts as a single encounter. This means that the Karma Pool does *not* refresh after a runner makes a call.

The gamemaster should keep in mind that no one will part with this sensitive, valuable data unless they get big nuyen or something else of real value in return. Contacts regard this "hot info" as a little nest egg put by for a rainy day, and will most likely only let it go for a credit transfer of, say, 10,000–30,000 nuyen. If he wishes, the gamemaster may set the price of this information at 5D6 x 1,000 nuyen.

HELP FROM PETRA

Depending on how they conducted themselves during their time in Dublin, the runners may have two useful contacts in the Tir: Petra Johnson and Bridgit or Padraic O'Toole. Of these contacts, Petra can provide a gold mine of useful information.

The runners should have a number for Petra Johnson at the Flathail or the Inter-Tir Hotel. Once they phone her, she knows something odd is afoot. From their absence at dinner, she figured out that the runners left hours ago with Rosenberg and MacSweeney; the VIPs' return without the runners makes her suspicious.

In order to get anything out of Petra, one member of the team must make a successful Etiquette (4) Test. The runner who befriended Petra earlier in the adventure should do the talking; if another runner speaks, increase the target number for the Etiquette Test by 1. Petra becomes alarmed on hearing even the most abbreviated version of events, and so the runner must reassure her that the group can handle the problem with no more than a little help. If the runner fails to project authority and confidence, increase the Etiquette Test target number by 1.

The runners must also convince Petra that they do not intend to act against MacNamara; after all, he is Petra's employer and meal ticket. An example of the right approach might be the following: "Petra, Mr. MacNamara asked us to help MacSweeney and Rosenberg with security for a top-secret meeting. Unfortunately, things went wrong; we've been left in the lurch, but we're working to find out what happened and why. We think some people in Mr. MacNamara's entourage are not serving his best interests, so please keep this confidential. We're don't know whether it's safe to return to Dublin, so we're going to work from where we are. But I need a little help from you to put things straight. Can you do it?"

If the runners make their first attempt to contact Petra after 2:30 a.m., they discover that the entire entourage has moved. Any runner trying to phone any member of MacNamara's party must make a successful Interrogation (6) Test to wheedle the entourage's new location and number out of the Inter-Tir Hotel receptionist. Reduce the target number if the runners offer a convincing line. If the test is unsuccessful, the runners may phone large hotels near Shannon Airport at random to track down MacNamara. Once they call the Shannon Bridge Hotel, a runner must make a successful Interrogation (6) Test to persuade the receptionist to admit that MacNamara has moved there. If *this* test is unsuccessful, the



runners can try hacking into the hotel systems to check reservation lists (see **Red Haze**, p. 42). If the runners have no cyberdeck, see **Night Stalkers**, p. 40, for a way to acquire one.

The most likely requests for information that the runners will make of Petra are listed below. For any request, whether for money or anything else (see **Other Necessities**, p. 37 of this section), subtract 1 from all target numbers if the runner also has Leadership 3 or higher; a confident, commanding tone helps persuade Petra to act. If none of the runners befriended Petra in Dublin, increase the target numbers by 1. If any runner got friendly enough to share at least one excursion with her earlier, reduce the target numbers by 2.

Background Information

The runners might ask Petra to find extensive background information for them, according to the guidelines given below. The gamemaster must determine what contacts Petra has back in

America, and how much of the following information she can actually obtain.

If the requested information is available on a bulletin board, the runners must make a successful Charisma (2) Test to obtain it. A smart runner might ask Petra for something this easily available, just to calm her nerves with a simple task.

If the runners ask Petra for any inside information on members of the MacNamara retinue, a successful Charisma (5) Test reveals any of the information on these characters listed in **Legwork**, except for data labeled hot information. Petra also has information that most other contacts do not. A successful Charisma (8) Test persuades her to reveal the following:

PETRA'S INFORMATION

Caspar Rosenberg

"I heard Mr. Rosenberg was involved with some kind of magical group in Boston a few years back. I don't know any details." (This story is not entirely accurate; if the runners tell it to a suitable contact back home, he or she may provide the correct version. See **Legwork**, p. 61.)

Nathair MacSweeney

"I overheard him making a phone call to some chummer in Tir Tairngire or maybe Minneapolis before we left New York. At least, I think it must have been there, because he used the name "Prince" a couple of times when addressing the guy." (If runners ask a contact back home about this specific matter, they get extra information about this link.)

Peter Lewis

"I think Peter has a chip habit, you know? He kinda shakes first thing in the morning. I've never actually seen him use BTL, but I'm pretty sure he's an addict. Mr. Rosenberg remarked about it to me once."

Petra knows nothing about the other entourage members that the runners cannot learn from other contacts (see **Legwork**). She has no dirt on MacNamara, and if she did she would refuse to tell the runners about it. If pressed hard on MacNamara, she gets edgy; add 1 to all Charisma Test target numbers for the remainder of the conversation.

At the gamemaster's discretion, Petra also knows one item from the "hot information" listed for members of MacNamara's entourage, except for the information about MacNamara or MacSweeney. Because Petra gets very nervous about giving away real inside dope, the Target Number for extracting this piece of information is 8, as for any piece of hot information (see **Legwork**). No modifiers may reduce this target number.

Investigations

The runners may also ask Petra to do some snooping for them on members of MacNamara's entourage or on O'Toole Transcom. If the runners contact Petra before 1 a.m. and persuade her to eavesdrop on the VIPs, she overhears the following snippet of conversation around 1 a.m. When the runners next contact her, she recounts it for them if a runner makes a successful Charisma (5) Test.

"Everyone's real upset. I heard Mr. MacNamara say that everything had to go smoothly and could they cover things up? Mr. MacSweeney said he'd do what he could and use his contacts. Mr. MacNamara seemed really grateful for that. Mr. Wassall said the deal was off and the European Party was real angry. Then Mr. Rosenberg said if we could cover everything up, the European Party might calm down. Mr. MacSweeney said okay, but make sure they know outsiders blew the security. He said you guys must have done it. They've got it in for you now; I really wouldn't come back here if I were you. Mr. MacSweeney said he would go to the boil, I think, first thing in the morning. Mr. MacNamara seemed relieved about that. I don't know why."

This information tells the runners that MacSweeney has made them the fall guys, identifies the elf as a prime mover in events from here on in, and should suggest that the runners track him down. When Petra heard MacSweeney say he was going to the "boil," he was referring to Boyle Abbey (**Plants With Attitude**, p. 52). If the runners want to find out more about MacSweeney's destination, they must hack into the Shannon Bridge matrix system (see **Red Haze**, p. 42).

The simple phrase "go to the boil" gives the runners a clean shot at deducing MacSweeney's location. If they consult a map of Tir na nOg, they find only one town named Boyle (see the Tir map, **Player Handouts**). They can also discover that Boyle Abbey is the corporate headquarters of Sculpted Environmental Systems, Inc., a major Tir corporation.

The runners may have the plans of O'Toole Transcom's Rosslare facility in their possession, snatched from the meeting room at Altan Lodge (**Terror in the Dark**, p. 27). If they pump Petra for information about this, she can only tell them: "All I know is that Mr. MacNamara plans to have O'Toole Transcom provide logistical assistance for planning and redevelopment of the New York traffic and subway systems." If the runners do not already know this, Petra can also tell them that Rosslare is a major trading port for ferries running between Fishguard in Wales and Cherbourg and Le Havre in France.

The runners cannot persuade Petra to deck into Tir corporate or security systems for them; she just never does that kind of thing and lacks the right software anyway. If the runners make a successful Charisma (10) Test, they may persuade her to enter an American system. However, she must have passwords and a decker to help her within that system in order to obtain useful information for the runners. How successful Petra is depends on the gamemaster's discretion.

Petra refuses to go too far from the MacNamara entourage in order to meet with the runners; such behavior poses too many risks. If the runners return to Dublin and hide from MacNamara in the city, a successful Charisma (9) Test by one of them will persuade Petra to meet him or her for coffee somewhere near Shannon Airport close to the hotel. The runners most likely will not want to go anywhere near Shannon, but if they do, the gamemaster must make his own decisions about what the runners can ask of Petra.

AID FROM AN O'TOOLE

Because Bridgit and Padraic O'Toole are influential, well-connected individuals, the gamemaster must be careful that their help does not make this adventure too easy for the runners. The tests the runners must make to obtain information or other help from Bridgit or Padraic assume that one of the runners has sparked the romantic interest of one or the other O'Toole. If this has not happened, increase the target numbers for the tests or otherwise limit the O'Tooles' willingness to help. As noted in **Dark Blue Eyes**, p. 25, either Bridgit or Padraic (but not both) become involved with the runners, depending on the gender of the player character with the highest Charisma.

Information

As with Petra Johnson, the runners may fish for a lot of information. The most likely questions are covered below; for certain information, Bridgit only reveals it if the runners ask the right questions.

Though Bridgit responds to the apparent gravity of the runners' situation, she finds something irresistibly romantic about it. After all, she never gets this kind of adventure. Bridgit's inamorata should play up the drama all he can; adjust all target numbers for tests according to how well the runner manages this. Bridgit refuses to believe the runners are terrorists, and backs her hunch on this score unless the runners do something foolish to make her think otherwise.

Bridgit also lets the runners know that they will owe a few favors in return for help. This device allows the gamemaster to send the runners back to the Tír in a later adventure if either of the O'Tooles think it would be fun to make use of them.

If the runners have the plans of O'Toole Transcom's Rosslare installation, they can use them to embellish their story. For example, they may tell Bridgit, "We have some information from abroad that suggests someone back in the States may be allied with terrorists to target Rosslare. We can't risk going to the authorities yet, because we need additional evidence to make sure we bring the right people to justice. And we need your help to do that." However, this tactic may harm more than it helps. No matter what, Bridgit absolutely refuses to give the runners any extra information about the Rosslare installation. She may also point out that, for all she knows, the runners stole the plans. Though she does not truly believe this, mention of the plans may make her wary.

If the runners ask about MacNamara, Bridgit supplies the same basic information that Petra Johnson can recount. If the runners make a successful Charisma (5) Test, she also tells them that Pat MacNamara is distantly related to the powerful MacNamara family of Tír na nÓg, but she knows nothing of any political angle to his visit with regard to that family. As far as she knows, MacNamara confined himself to cadging money from O'Toole Transcom, racking up photo-opportunities, and tightening his grip on the New York Irish vote. No deeper intrigue was involved, and Bridgit knows squat about the members of the MacNamara retinue.

If the runners question her about Rosslare and make a successful Charisma (5) Test, Bridgit says smuggling of BTLs from southern Europe is a major problem at the installation.

If the group asks Bridgit specifically about criminal organizations active in smuggling through Rosslare, she says that most of it is unorganized and opportunistic. If she has already provided the

Rosslare information or if the runners make a successful Charisma (5) Test, she says, "I guess the Mafia are the worst. We really don't have any yakuza activity or anything like that over here." If asked about terrorist groups, Bridgit can supply the background information recounted in **Legwork**, p. 65.

If the runners ask about security forces or police involvement in the case, Bridgit becomes nervous. She has no direct contacts in the TRC or Garda, and therefore will have problems pulling strings to get paydata. However, if a runner makes a successful Charisma (9) Test, she agrees to use her contacts to find out what she can.

After 1D6 + 2 hours, Bridgit tells the runners that the authorities believe they have links with a terrorist organization. If the runners make a successful Charisma (9) Test at this point, Bridgit calls back in an hour to report that the terrorist organization is the INLA.

OTHER NECESSITIES

In addition to information, the runners may need money, transportation, gear, weapons, and a safe place to hide until the heat blows over and they can escape Tír na nÓg. As with information, Petra Johnson and Bridgit or Padraic O'Toole represent the runners' best hope for obtaining the equipment and other things they need.

MONEY AND TRANSPORTATION

The runners may ask Petra to wire some money to a bank near whatever cheap hotel they hole up in, but the bank won't open until 9:30 a.m. (see **Gamemaster Itinerary**, p. 22 of **Don't Ask for Scotch**). In order for Petra to agree, the runners must make a successful Charisma (5) Test. Raise the target number by 1 for every £1,000 they request above £3,000. If the runners want Petra to hire a car for them, they must make a separate, successful Charisma (5) Test. Though she will not bring it in herself, Petra will make sure that the car is delivered to the team.

As for Bridgit, she can make any amount of money or any vehicle available to the runners. Frag, she can even dispatch a courier to deliver it. However, the runners must give her a good, believable reason to accede to these requests. The runners must make a successful Charisma Test, with a Target Number of at least 3, modified according to the overall situation at the gamemaster's discretion.

WEAPONS AND EQUIPMENT

In addition to money and transport, Petra may ship the runners any kind of equipment legal in the Tír, but the delivery time makes this option unattractive to the runners. If a runner makes a successful Charisma (4) Test, however, Petra ships the team decker his cyberdeck from the vacated suites at the Inter-Tír Hotel. She ships the deck by rail express; the shipment must be made to a major town, and takes four hours to reach any large town from Shannon.

Bridgit may also get the runners legal equipment, but forget weapons, chummer. If the runners ask for weapons, Bridgit openly wonders whether the runners may be thieves and terrorists after all. Raise all target numbers for dealings with her by 2 for the remainder of the adventure unless the runners back off immediately and explain that they just feel panicky after being shot at. In this case, raise the above-mentioned target numbers by 1.

SAFE HOUSE

If the runners make it back to Dublin and ask Bridgit to help out with accommodations, she tells them about an empty flat owned by a friend of a friend that they can use as a safe house. Use the Medium Residence Location Archetype, p. 33 of **Sprawl Sites**. Bridgit tells the runners that the flat is on Curtis Street, just off York Street, and suggests they break into it, as the owner will be away for a few days. The place has minimal security, the exact level determined by the gamemaster depending on the skills and equipment the runners possess. Bridgit advises the runners that because the owner, Niall MacGuinness, is on holiday for a week, the runners should stay out of sight and keep quiet to avoid arousing the neighbors' suspicions. If they put the trideo on too loud or otherwise attract attention, add 1 to their visible action tally.

If the runners manage to hole up safely in the flat but one of them has been courting Bridgit (see **Dark Blue Eyes**, p. 25), add 2 to the group's visible action tally. Bridgit's father has checked out the runners in an effort to protect his daughter; once the TRC starts hunting the runners, the police find out about these checks. As mentioned in **Dark Blue Eyes**, dating Padraic does not add anything to the visible action tally.

Alternatively, the runners may try telling Bridgit, "Look, we can't expect you to trust us. What if we hide out at one of the O'Toole sites—Rosslare, the Dublin headquarters, wherever you like. We'll hand over our weapons to your security people; all we want is time to clear our names. Just give us time to prove we are no threat to Tír na nÓg or to your family or business. We're innocent, and we need help."

If the runners suggest anything like this, reduce their visible action tally by 6. Bridgit arranges passage for them to a Dun Laoghaire outstation, where the runners must surrender their weapons to a dozen O'Toole Transcom security men (use the Street Cop Archetype, p. 211, **SR11**). This arrangement radically changes the runners' options for their next move. From Dun Laoghaire they cannot travel, but they can do all the decking they want. Bridgit gives them a Fairlight Excalibur, with a cutting-edge anti-trace program built into it, so that the runners cannot be traced back to Dun Laoghaire (see p. 173, **SR11**, for the Excalibur's statistics). However, if the TRC turn up (**Green Heat**, p. 48) at the outstation, Transcom immediately hands over the runners.

MEETING THE RUNNERS

Although Bridgit worries about the runner she's involved with, she does not drive across the Tír to help out or come alone to the apartment in Dublin. If the runners want to meet with her for some reason, they must find some quiet, secluded back-alley pub in Dublin. This means that they cannot meet Bridgit until lunchtime the following day (Day 5). All this time, of course, Tír security forces are hunting the runners hard. In other situations, the gamemaster determines Bridgit's behavior. As stated earlier, Petra will only agree to meet the runners in extreme circumstances, somewhere near Shannon Airport.

DECKING

In addition to Petra and Bridgit, decking can provide the runners with considerable information. **Red Haze**, p. 40, provides details on the Tír's matrix systems as well as other pertinent information on decking in this adventure. If the runners use the Fairlight from Bridgit to hack into the TRC database, they discover



that MacSweeney's datafile is heavily protected. At this point, they may assume that MacSweeney has powerful friends in the Tír and ask Bridgit to find out who they are. At the gamemaster's discretion, Bridgit may ask her father about MacSweeney and discover his connection to Dominic O'Brien, a powerful Danaan elf (see **Cast of Shadows**, p. 71).

BACK IN SHANNON

As noted on the gamemaster's itinerary (**Don't Ask for Scotch**, p. 21), MacSweeney, Rosenberg, and their bodyguards return to the Inter-Tír Hotel near Shannon Airport around 9:40 p.m. and brief MacNamara on the attack at Altan Lodge. The Irish Mafia contacts, furious at the debacle, break off negotiations with MacNamara. Knowing that this means the Mafia back Stateside will turn on him, MacNamara panics. Because Rosenberg is still shell-shocked and Wassall is too junior to call the shots, MacSweeney and Anthea Brown effectively control what happens next. MacSweeney suggests they wait before notifying the authorities, claiming the delay will allow him time to use his Tír contacts to try and hush the incident up. MacNamara agrees eagerly, desperate to avoid publicity. Brown also agrees, because MacNamara's first engagement on the following morning is a wiz photo-op that includes lots of Celtic ritual sites and a public flesh-pressing with Judge Martin MacNamara. She does not wish anything to disrupt the meeting with the judge, who is immensely influential in the powerful Danaan Council of Stewards (see p. 48, **Tír na nÓg**). For all of MacNamara's people, the short-term goal

is to keep everything quiet and the rest of the tour running smoothly. MacSweeney notifies the Garda and TRC of the attack around 3 a.m. on Day 5, after six hours have elapsed.

For some hours after the assault on the Altan Lodge, MacNamara's senior aides continue to worry that they may be linked publicly to the incident. MacNamara and Rosenberg dream up countless scenarios that attempt to satisfactorily explain the attack without suggesting any involvement on their part, to which MacSweeney replies with deflating comments along the lines of "You've forgotten *this*; I know Tír na nÓg, and it won't be that simple." The briefing/spin control meeting breaks up at 2:15 a.m., and the entourage moves to the Shannon Bridge Hotel soon afterward. Petra Johnson overhears some of these discussions, and the runners may be able to learn about them if they contact Petra and enlist her help quickly enough.

SUBSEQUENT ENCOUNTERS

From this point, the adventure proceeds to one or more of a number of encounters, depending on the runners' actions. The gamemaster should consult his itinerary, because the attack at Altan Lodge has triggered numerous events that may occur simultaneously with the runners' investigations. A few of these events, as well as the encounters to which the runners may proceed, are noted below.

Night Stalkers, p. 40, describes an encounter with fomorians in the forest surrounding the mansion. Because this encounter is not vital to the plot, the gamemaster may feel free to skip it. However, the runners can garner some much-needed help from a local farming family, the McDonnells, if they roleplay their way through the encounter well enough. Among other things, the McDonnells may give them a cyberdeck.

Red Haze, p. 42, covers the decking options open to the runners and includes a battle with TRC opposition.

Green Heat, p. 48, describes the actions of and possible encounters with security forces in pursuit of the runners. After MacSweeney gives the Garda an anonymous tip about events at Altan Lodge at 3 a.m., a Garda team arrives at the Lodge to investigate. At 3:20 a.m., having recognized some of the dead as INLA terrorists, the Garda notifies the TRC.

By 4 a.m., a TRC team has begun hunting the runners in connection with the attack, largely because of the false data on the runners' terrorist links that MacSweeney has had planted in the TRC computer system (see **Red Haze**). **Green Heat** includes a time frame for the pursuit as well as hints for triggering and staging the encounter in which the TRC finds the runners. Any attempt by the runners to directly confront MacNamara at his hotel or later during Day 5 along the tour route also triggers this encounter.

Political Gambit, p. 50, describes the events that transpire if the runners try to cut a deal with MacNamara to save their hides.

Plants With Attitude, p. 52, describes the events that transpire if the runners successfully trace MacSweeney to Boyle Abbey. If the group is holed up under Bridgit's protection in Dun Laoghaire and chooses to confront Nathair MacSweeney, Bridgit calls in the TRC and demands that the runners surrender with the evidence they have; she promises to deal personally with the head TRC officer, Mairtin O'Neill, to ensure that he allows them the chance to make a run on Boyle Abbey.



NIGHT STALKERS

Gamemaster's Note: Modify the following introduction if the runners detect the fomorians in advance with a detect enemy spell or the like.

TELL IT TO THEM STRAIGHT

Weird howls and hoots fill the dark forest all around you as you wander through the chilly night. You wish that the noises didn't sound so much like a baby being strangled—it really gets on your nerves. You're not sure how far away the road is; you peer through the dark, desperate for a glimpse of it. Gradually, you make out a few hillocks to your left that look like enormous molehills. Suddenly, the molehills stand upright and charge straight at you. The fraggin' things look a little like trolls, but they have huge limbs, hands and feet like shovels, and knobs sticking out all over their skins. They stand about three meters tall, and if they went on a diet for a while they might just get down to 300 kilos. In fact, these things make ordinary trolls look like Maria Mercurial. As the monstrosities approach you, the wind shifts and a stench like a corrosive acid burns the back of your throat. Time to fight or run, chummers. Time to fight or run.

BEHIND THE SCENES

This encounter tests the runners' ability to survive without relying on big guns. If it looks like the runners are going to fail, the gamemaster may have the proverbial cavalry turn up in the form of local farmer Hugh McDonnell and his sons, Rory and James. The gamemaster may also have the McDonnells appear if the runners have no cyberdeck and no immediate prospect of getting one, or if he wants to make life easy for the runners by giving them directions, information about the area, and the like. Assume that the runners first see the fomorians roughly 20 meters away through the fog.

FOMORIANS (3)

B 10/3 **Q** 4x2 **S** 11 **C** 1 **I** 3 **W** 4 **E** 5 **R** 3 **Attacks** 9D, +1 Reach

Initiative: 3 + 1D6

Threat Rating: 1 per runner

Powers: Corrosive Secretions, Enhanced Physical Attributes (Strength, three times per day, increased by 3 for 5D6 turns), Enhanced Senses (Thermographic Vision), Essence Drain (Temporary), Magical Resistance

Weaknesses: Allergy (HCFC gases, Severe), Allergy (Sunlight, Nuisance)

Fomorians are trolls infected with HMHV-II. Though not particularly bright, these nasty furballs are physically powerful and clever enough to use their powers to maximum effect. To reflect the use of their enhanced physical attributes power to boost Strength, add 2 points to the Strength value given above. Note that fomorians do not believe in complex tactics; they simply charge the runners and rip the head off of anyone they can catch.

CONDITION MONITOR	
	LIGHT STUN MODERATE STUN SERIOUS STUN DEADLY STUN
STUN	1/10 2/10 3/10 4/10
PHYSICAL	1/10 2/10 3/10 4/10
	LIGHT WOUND MODERATE WOUND SERIOUS WOUND DEADLY WOUND

CONDITION MONITOR	
	LIGHT STUN MODERATE STUN SERIOUS STUN DEADLY STUN
STUN	1/10 2/10 3/10 4/10
PHYSICAL	1/10 2/10 3/10 4/10
	LIGHT WOUND MODERATE WOUND SERIOUS WOUND DEADLY WOUND

CONDITION MONITOR	
	LIGHT STUN MODERATE STUN SERIOUS STUN DEADLY STUN
STUN	1/10 2/10 3/10 4/10
PHYSICAL	1/10 2/10 3/10 4/10
	LIGHT WOUND MODERATE WOUND SERIOUS WOUND DEADLY WOUND

MCDONNELLS (3)

B 5 **Q** 5 **S** 5 **C** 4 **I** 4 **W** 5 **E** 6 **R** 5 **Armor** 4/3

Initiative: 5 + 1D6

Threat/Professional Rating: 2/2

Skills: Armed Combat 2, Firearms (Shotguns) 6, Stealth 2

Special Skills: Farming 4

Cyberware: None

Gear: Ancient Shotguns [Shotgun, 8 (clip), SA, 7S], Heavy Knives (6L), Pitchforks [Reach 2, 5S]

The statistics given above apply to Hugh McDonnell and his two sons, all tough, self-reliant farmers. Their old shotguns seem like flintlocks compared to more sophisticated modern weapons, but these museum pieces still pack quite a punch. The McDonnells wear thick, padded clothing that provides a fair amount of protection, but they prefer shooting at the fomorians from a distance rather than engaging in hand-to-hand combat with the beasts.

CONDITION MONITOR	
	LIGHT STUN MODERATE STUN SERIOUS STUN DEADLY STUN
STUN	1/10 2/10 3/10 4/10
PHYSICAL	1/10 2/10 3/10 4/10
	LIGHT WOUND MODERATE WOUND SERIOUS WOUND DEADLY WOUND

CONDITION MONITOR	
	LIGHT STUN MODERATE STUN SERIOUS STUN DEADLY STUN
STUN	1/10 2/10 3/10 4/10
PHYSICAL	1/10 2/10 3/10 4/10
	LIGHT WOUND MODERATE WOUND SERIOUS WOUND DEADLY WOUND

CONDITION MONITOR	
	LIGHT STUN MODERATE STUN SERIOUS STUN DEADLY STUN
STUN	1/10 2/10 3/10 4/10
PHYSICAL	1/10 2/10 3/10 4/10
	LIGHT WOUND MODERATE WOUND SERIOUS WOUND DEADLY WOUND

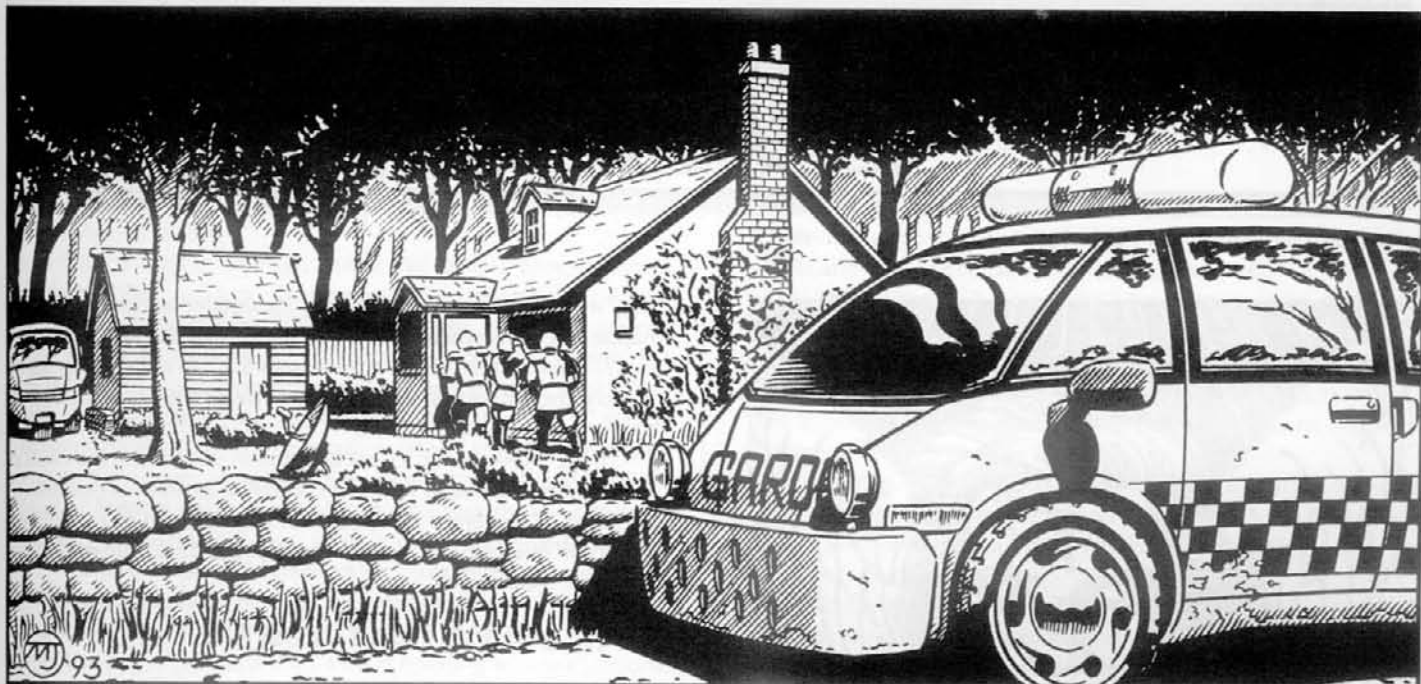

The McDonnells may appear any time during the runners' encounter with the fomorians. The three men have been tracking the beasts for some time, trying to locate their lair and inform the authorities, who usually send army troops to deal with fomorians. These beasts rarely present a major hazard to man, but this particular group has proved unusually predatory.

The McDonnells willingly take the runners back to the family farm, roughly eight kilometers southwest of Altan Lodge, and put them up overnight (with plenty of Irish whiskey to celebrate the victory). If anyone is badly hurt, the McDonnells call for emergency medical services. Knowing that medical help will tip off the authorities to their location, the runners may flee if this happens, which the McDonnells will find suspicious. A farmhand competent at first aid can treat minor injuries. The gamemaster determines the farmhand's exact skill level, but in any case the strongest medicine this chummer has is a trauma patch.

The McDonnells wonder why a group of foreigners are wandering about the forest late at night, but any vaguely plausible excuse allays their suspicions. Rory and James are much more interested in hearing whether everyone packs a weapon in America, whether the streets of New York are truly paved with gold, how UCAS trid stars live, and so on.

The McDonnells live too far away from Altan Lodge to have heard the attack, and will know nothing about it because the authorities will not publicize it. They happily give the runners a map of the area and may even sell the runners petrol or foodstuffs. The McDonnells may also be persuaded to sell their farm truck for £10,000 or so, but the sale would have to be cash. Needless to say, the truck is ancient and battered. Game statistics for this vehicle appear below.

The McDonnells also have a telephone at the farm, and Rory is the proud owner of a Radio Shack PCD-100 (p. 173, **SR11**), which he bought for next to nothing "when it fell off the back of a lorry,

like." In a chipset with the deck are the following programs: Attack 2, Analyze 2, Browse 2, Evasion 2, Masking 2, and Sensors 2. Rory will sell the whole package for £5,000, three times what he paid. Though a miserable piece of work as far as serious cyberware goes, the deck is in perfect working order because Rory has no idea how to use it. If the runners have no other hope of getting their hands on a cyberdeck, this one is better than nothing.

To roleplay this encounter, bone up on the weirdnesses of rural Irish language (see **Street Slang**, p. 163, **Tír na nÓg**). The runners should not stay overnight at the farm because it is too close to Altan Lodge: if the runners are still at the farm after 7 a.m., a squad of four Garda officers stops by to make enquiries. For game statistics on these officers, see **Green Heat**, p. 48. If the runners attack and kill the Garda squad, increase their visible actions tally by 6. This action makes them bona fide police killers, and only the most powerful help will enable them to get out of Tír na nÓg alive (see **Plants With Attitude**, p. 52).

FARM TRUCK

Handling	Speed	B/A	Sig	APilot
3/6	20/60*	1/0	4	0

Seating: 1

Economy: 1 PF per km

Power: Elec/200 PF

Storage: 1 CF underseat

*Pedal Speed 5/21

DEBUGGING

If the runners get seriously mauled by the fomorians, the gamemaster may have a whiskey-sodden local doctor help the runners out (use the **Street Doc Contact**, p. 211, **SR11**). If the runners loot the farmhouse and scrag the McDonnells, add 4 to their visible actions tally. This violence does not end the adventure, but it hastens the day of reckoning for the runners.

RED HAZE



Not a standard encounter, this section describes the runners' decking options. What they can learn by decking and where in the various Matrix systems they go hunting depends on their actions in previous encounters. If the runners do not have a cyberdeck,

they may be able to acquire one; for details on how this might happen, see **Night Stalkers**, p. 40, and **When the Smoke Clears**, p. 32. If the options given in those sections will not work for some reason, the gamemaster must improvise another opportunity for the runners to obtain a deck.

If the runners have a deck but remain stuck out in the wilds of Connaught, they need to find a commline as soon as possible. A successful Electronics (B/R) (4) Test allows them to construct a makeshift interface to the commline, by which the team decker can enter the Matrix.

RACE AGAINST TIME

Nathair MacSweeney's offstage skulduggery to frame the runners as terrorists (**Gamemaster Itinerary**, p. 21, **Don't Ask for Scotch**) leaves the runners a limited amount of time in which to hunt for info before the Garda or TRC catch up to them (**Green Heat**, p. 48). The runners' most likely decking options include the following. They may hack into the treuntas Matrix system (see p. 161, **Tír na nÓg**) to find mundane information such as maps, road routes, news, and so on; try cracking police databases for info on the Altan Lodge assault; look through aviation authority or property ownership databases to find the owners of the choppers or Altan Lodge; hack into the Shannon Bridge Hotel database to find MacNamara; check out the Boyle Abbey system for details on its security arrangements; or hack into a foreign database. Details for hacking into the Boyle Abbey system are provided in **Plants with Attitude**, p. 52. All others are listed below.

In addition to decking, the runners may contact friends outside the Tír for information via vidphone. See **Legwork**, p. 61, for details on such telenetworking.

MUNDANE INFORMATION

Maps, details of rail services and road networks, and the like can easily be accessed from the public treuntas Matrix system; the runners need make no tests to get this data. The runners may also tap into the news services; if they do, they find no reports of the attack at Altan Lodge. If they check for news reports on the MacNamara entourage, everything appears to be going exactly as scheduled in the tour itinerary.

If the runners check public-access bulletin boards for general information on terrorists, they automatically trigger trace and report IC. However, the security code for this database is only Orange-2, so they should defeat it easily. If they fail, add 2 to the team's visible action tally. In any event, they acquire nothing more than general background information (see **Legwork**, p. 61).

POLICE SECURITY SYSTEMS

The runners may try hacking into police databases to find out what law enforcement knows and is doing about the assault at Altan Lodge (see **Small Police System**, below). If the team decker accesses a single datastore in a police system, however, add 1 to the group's visible action tally. If the decker manages to access DS-17 in the TRC system (see **TRC Derry System**, following), add 2 to the visible action tally.

When snooping through police databases, time becomes important. Prior to 3 a.m., the runners find no information pertaining to Altan Lodge. After 3:30 a.m., however, they find a general alert to police forces within 160 kilometers of Altan Lodge. The alert describes the runners, notes their suspected terrorist affiliation, and instructs anyone sighting them to notify the TRC station in Derry. Provincial police systems contain no truly sensitive data, and so the runners must look elsewhere for specifics about their falsified terrorist links. Only police station systems in Connaught receive the alert until 8 a.m., when it becomes Tír-wide.

The runners can get details on their suspected terrorist ties by hacking into the TRC system. If the team decker manages to hack into DS-5/17 in the TRC system (see **TRC Derry System**, following), that player character finds a file containing accurate personal information about him as well as two entries that describe him making runs stateside to raise money for the Irish National Liberation Army. If the runners checked their own files at any time prior to 8 p.m. the previous day, they do not find this falsified information.

In addition to the system at Derry, the TRC maintains identical systems in Armagh and Dublin. Actually finding the TRC system may prove difficult; the security code for the system SAN is Red-7. If the decker fails to locate the TRC system, the gamemaster might suggest he try hacking into the database of a local Garda station.

Small Police System

The **Small Police System** map below shows the structure of a typical system at a rural police station.

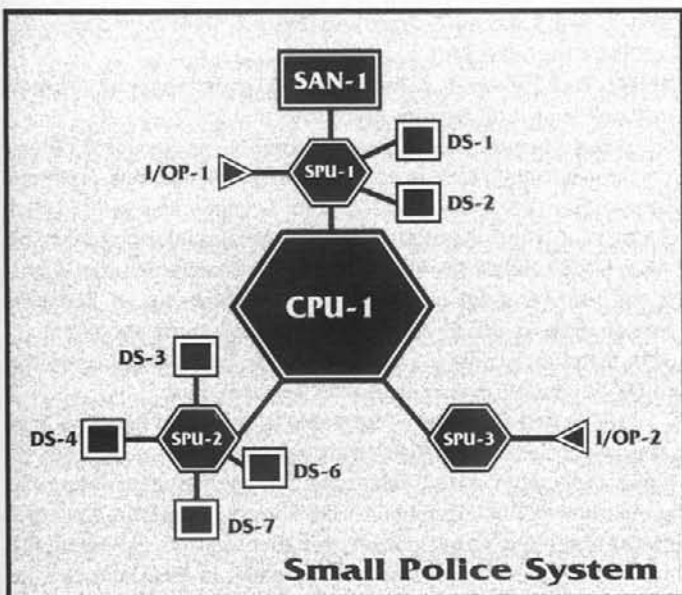

CPU = Central Processing Unit

DS = Datastore

I/OP = Input/Output Port

SAN = System Access Node

SPU = Subprocessor Unit

SAN-1: Orange-3. This node provides access to the Matrix.

SPU-1: Orange-2, Access 4, Tar Baby 4. Manages data traffic to the CPU and also to internal police station terminals.

DS-1: Orange-2, Access 4. Civil monitoring data, traffic data, public order, and other such trivial information.

DS-2: Orange-4, Access 5, Trace and Dump 4. This datastore contains information on local crime not considered sensitive or important. The datastore contain no information on organized crime, terrorism, and the like.

I/OP-1: Orange-4, Access 5, Barrier 4. This port serves the main police station terminal.

CPU-1: Orange-4, Tar Pit 4, Barrier 5. This CPU provides the system's horsepower.

SPU-2: Orange-4, Barrier 5, Trace and Dump 4. This node guards access to sensitive datastores.

DS-3: Orange-4, Access 4. Personnel records. These contain nothing especially sensitive; the Garda just happen to be paranoid about their personal files).

DS-4: Orange-4, Barrier 5. Directory of Matrix and phone numbers for important contacts, emergency services, military numbers, and a TRC directory. From here, the runners can get the number of the access SANs of the TRC Derry matrix system.

DS-5: Orange-3, Access 4. This datastore holds out-of-date archives, unreliable information from local informants, and other useless data.

DS-6: Orange-4, Access 4. This contains data on sensitive, current cases. After 3:30 a.m., the decker finds a simple, factual summary of the Altan Lodge attack in Connaught police systems. After 8 p.m., he can find it in all police systems. Describing the runners as armed and dangerous, the summary notes the runners' terrorist affiliation, but provides no details.

SPU-3: Orange-3, Access 4. This node handles automated traffic signals in the district.

I/OP-2: Orange-3, Access 4. This port relays data between traffic signals and SPU-3.

TRC Derry System

This system is an absolute brute to crack. To successfully deack into it, the runners must have a top-flight decker or access to a high quality cyberdeck, preferably both. If they lack a good decker, they're dreck outta luck; neither of their Tír contacts or anyone outside Tír na nÓg cares to take a crack at the TRC system for them. If they have a decker but a run-of-the-mill deack, Bridgit O'Toole is their only real hope for acquiring better equipment. Getting a deack from her probably means a trip to Dublin (**When the Smoke Clears**, p. 32). The gamemaster may want to remind the players that getting out of Connaught and deacking from a variety of places to elude pursuit is a wise move; they could do worse than catch up with Bridgit in Dublin. The gamemaster must carefully determine what decks and programs are available during the adven-

mine what decks and programs are available during the adventure; anything less than a Fuchi Cyber-6 does not give the runners much of a chance.

Unlike the small police station system described above, the TRC Derry System is a sculpted system. A summary of the special rules for a sculpted system is provided in the following pages; for a more detailed description, see the **Virtual Realities** sourcebook. The TRC system uses organic and pastoral images as its primary sculpting motif. Personas of TRC deckers appear as mythic Irish heroes, usually with some terrifying aspect; the hero Cu Chulainn is the most frequent icon used by such deckers. Datastores are represented as subterranean burial cairns, and datafiles appear as oval stones covered in Celtic designs and Gaelic characters.

AccessIC appears as a bolted wooden gate, barrier IC as a thorny hedge. Scramble IC takes the form of a sorceress carrying a slim rosewood wand covered with signs and symbols.

The sorceress raises her wand threateningly when anyone tries to access a datastore without authorization. Whenever the scramble IC erases a file, the sorceress' wand shimmers with light and she smiles beatifically. Blaster IC takes many forms, usually those of mythic animals: bears, boars, stags, and horses are the most common. Attack by this IC appears as the natural attack of the relevant animal: stomping, goring, clawing, and so on.

Killer IC most often assumes the form of a fomorian (for details, see **Night Stalkers**, p. 40 or p. 46, **Paranormal Animals of Europe**), but it may also appear as an each-uisge (see p. 38, **Paranormal Animals of Europe**) or as a harmless-looking leshy armed with nothing more threatening than a long pin. The leshy icon, of course, is far deadlier than it appears. Tar baby IC usually appears as a banshee that clutches at a decker's utilities; once it has them in its grasp, the banshee wails and fades, destroying the utility as it disappears. Tar pit IC appears as a peat bog or wet ground, transforming into a toxic, oil-stained slick as it spreads over the utilities it is attacking. The affected utilities become stained and corroded, and then disintegrate.

The various trace programs usually take the form of Irish wolfhounds. Trace and burn IC appears as a fire-breathing black dog. Black IC appears as a member of the Reach fuileach, the elite assassins of the Tir, complete with all technological aids; it may also appear as a sword-wielding elven mage wearing a dark brown or gray cloak covered with Celtic designs. The elf icon also acts like a physical adept, performing martial arts maneuvers. Any TRC decker in the system also appears in this elven mage persona. The gamemaster should feel free to develop variants of images other than black IC as he sees fit.

In the TRC matrix, the sculpted reality is so powerful that it

imposes itself on the persona of any invading decker, altering the decker's image to fit the sculpted reality. For example, the decker might appear as a rustic peasant wearing ragged clothes half-covered in animal excrement; the TRC enjoys humiliating uninvited guests.

To resist this change, the team decker must make a Success Test using a number of dice equal to his MPCP Rating against the system rating of the node. For the Red-7 Derry SAN, the decker needs 4 successes at 7 or better; hardly easy, even with a Cyber-6. If the test is successful, the decker's persona appears as normal (and probably sticks out like a sore thumb). If the test is unsuccessful, the decker suffers a -2 penalty to his Reaction Attribute for the remainder of the run. The decker can try to overcome the sculpted reality again when he reaches a new node, but he does so with a +2 modifier to the target number. He may only make one attempt per node.

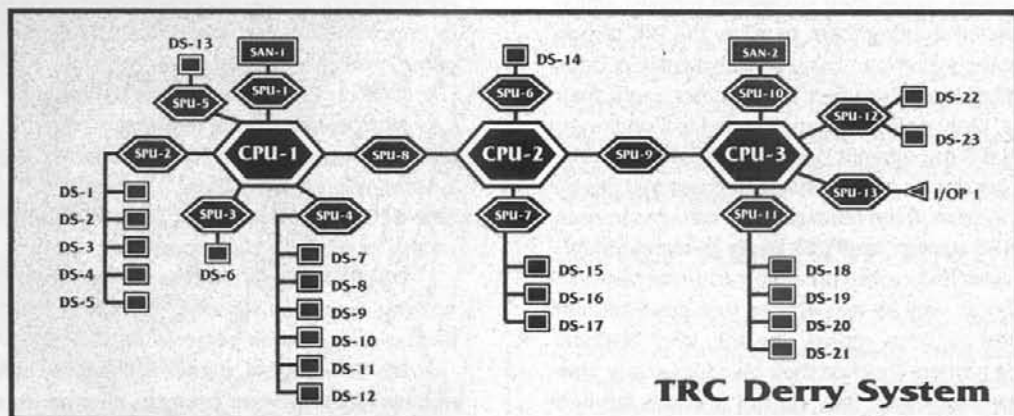

- CPU** = Central Processing Unit
- DS** = Datastore
- I/OP** = Input/Output Port
- SAN** = System Access Node
- SPU** = Subprocessor Unit

SAN-1, SAN-2: Red-7, Access 4, Trace and Report 4. These twin SANs provide access to the TRC matrix.

CPU-1: Red-7, Barrier 5, Blaster 5. This CPU provides the horsepower for the major subsystem of SPUs and datafiles that deal with terrorism.

SPU-1: Red-5, Access 5, Trace and Dump 5. This SPU guards entry to CPU-1 from the SAN-1.

SPU-2: Red-5, Black 4, Killer 5. This SPU guards against intrusion into one subset of datafiles on terrorism.

DS-1 through DS-5: Red-5, Scramble 5, Tar Pit 5. These datastores contain files on active terrorist organizations, arranged by province (DS-1 for Ulster, DS-2 for Leinster, and so on). After 3 a.m. DS-5, the Connaught datastore contains information on the Altan Lodge attack. The file is updated at certain times after 3 a.m. If the runners gain access to this datastore, go to **Terrorist Information**, p. 46, to determine what they know and when.

SPU-3: Red-6, Access 6, Trace and Burn 6. This SPU guards access to DS-6, which contains especially sensitive files.

DS-6: Red-8, Barrier 6, Scramble 8, Trace and Report 6. This database covers individuals living outside Tír na nÓg, both Tír exiles and foreign citizens whom the TRC has identified as terrorist sympathizers. This information might interest journalists and other media types, and might also be used for blackmail. However, the accuracy of this information varies greatly. In this datastore the



team decker can find his own falsified history (see **Terrorist Information**, p.46).

SPU-4: Red-6, Black-2, Access 6, Trace and Burn 6. This subprocessor guards access to the datafiles on recent terrorism.

DS-7 through DS-12: These datastores contain information on recent developments in terrorist tactics and strategy and state-of-the-art analyses of terrorist activity nationwide. As with DS-1 through DS-5, DS-7 through DS-11 are each devoted to separate provinces; DS-12 contains nationwide analyses of terrorist trends. Only terrorist activity that has occurred during the past 12 months is encoded in these datastores. The information in DS-11 on the runners and the events at Altan Lodge duplicates the information in DS-5.

SPU-5: Red-7, Black-5, Barrier 7, Killer 6. This forbidding subprocessor guards access to DS-13, an especially sensitive database.

DS-13: Red-7, Access 6, Scramble 6, Tar Pit 6. This database contains information on ongoing anti-terrorist activity. Because only senior TRC officers may update it with formal reports, this database is not updated to include information on Altan Lodge or the runners.

CPU-2: Red-8, Black-4, Barrier 6, Blaster 6, Trace and Dump 6. This huge CPU is the main source for "mobile" computing power throughout the system.

SPU-6: Red-7, Black-6, Access 7, Trace and Dump 6. This SPU

guards the ultra-sensitive datastore DS-14.

DS-14: Red-8, Black-6, Barrier 6, Scramble 8. This datastore contains selected information on members of the Danaan-mór, the Tír's most powerful ruling families. Extremely sensitive politically, this information is worth 30,000 nuyen per 10Mp block, for a total of 900,000 nuyen. Trying to sell or trade this information, however, attracts the attention of TRC assassins. The file on Bridgit O'Toole is cross-referenced to the file of the runner courting her in DS-11. This datastore also contains info on Dominic O'Brien.

SPU-7: Red-5, Barrier 5, Tar Pit 5. This subprocessor controls access to DS-15, DS-16, and DS-17.

DS-15: Red-7, Access 6, Trace and Burn 5. This datastore contains information on economic terrorism.

DS-16: Red-6, Access 6, Tar Baby 5. This datastore holds information on criminal economic enterprises run by foreign terrorist groups and organized crime. If the runners access this information, consult **The Mob**, p. 46.

DS-17: Red-5, Access 4, Tar Pit 4. This datastore holds information on foreign visitors who have been in the country during the past 12 months. The datafiles include backgrounds, histories, and travel itineraries. This information is worth 500,000 nuyen (10,000 per 10Mp block). If the runners look for files on themselves, they find duplicates of the files in DS-5 and DS-11. If the runners search for data on the MacNamara entourage, see **MacNamara's Boys**, p. 46.

SPU-8: Red-4, Access 4, Trace and Report 4. This subprocessor controls the flow of information between CPU-1 and CPU-2.

SPU-9: Red-4, Access 4, Trace and Report 4. This subprocessor controls the flow of information between CPU-2 and CPU-3.

CPU-3: Red-7, Barrier 5, Blaster 5. This CPU provides most of the computing power for one large datasystem and one smaller one and also handles SPUs linked to I/O devices in the system.

SPU-10: Red-5, Access 5, Trace and Dump 5. This SPU guards entry to the CPU from the SAN.

SPU-11: Red-7, Barrier 6, Trace and Dump 5. This SPU guards access to the sensitive datastores DS-18 through DS-21.

DS-18: Red-6, Barrier 6, Trace and Dump 6. This database contains a list of all registered Tír na nÓg hermetic mages. This information is worth 60,000 nuyen (6,000 nuyen per 10 Mp block).

DS-19: Red-6, Barrier 6, Trace and Dump 6. This store has a list of all registered Tír na nÓg shamans and non-elven druids. This data is worth 12,000 nuyen (3,000 nuyen per 10Mp block).

DS-20: Red-4, Barrier 5, Trace and Dump 5. This datastore contains a list of miscellaneous groups suspected of cultural crimes (see p. 44, **Tír na nÓg**).

DS-21: Red-7, Black-5, Barrier 6, Trace and Burn 6. This database holds information on members of the hermetic orders of the Paths (see p. 65, **Tír na nÓg**), the elite magical groups of Tír na nÓg. This information is worth 30,000 nuyen (3,000 nuyen per 10Mp block). A file in this datastore identifies Dominic O'Brien as a member of the Druidic Order of Ogma. Though the file contains no specific details of his initial grade, it identifies his residence as Boyle Abbey and states that he has a high rank in the order.

SPU-12: Red-7, Black-5, Barrier 7, Scramble 7, Trace and Burn 6. This heavy-duty SPU guards access to the vital research information stored in DS-22.

DS-22: Red-7, Black-5, Barrier 7, Scramble 7, Killer 7. This datastore contains experimental research findings on the morph-seeking weapons carried by the elite assassins of the TRC (see p. 41, **Tír na nÓg**). This data is worth 4,000,000 nuyen (100,000 nuyen per 10Mp block). Any attempt to sell this information attracts TRC assassins.

DS-23: Red-4, Access 5, Scramble 5, Trace and Burn 5. This datastore contains personal information on TRC operatives.

SPU-13: Orange-4, Barrier 4, Trace and Report 4. This subprocessor handles information flow from terminals to CPU-3.

I/OP-1: Orange-3, Access 4, Trace and Report 4. This port links terminals in TRC centers to the main system.

Terrorist Information

If the runners do not have the information on Tír na nÓg terrorist organizations from **Legwork**, p. 65, give it to them now. At 3:15, the TRC system contains a report of a fire at Altan Lodge apparently involving terrorists. By 3:25 the file includes confirmation of INLA involvement in the incident and notes the runners' presence. An update added at 3:55 notes that at least one body of a known Irish Mafia figure was recovered at the scene. If the runners dig out their own files, the team decker finds that his file notes terrorist links. The gamemaster should improvise the details to fit the character and history of the runner.

The Mob

An update to the DS-16 datastore in the TRC Derry system at 4:02 contains a file noting Mob involvement in the events at Altan Lodge. Accompanying analysis speculates that the fire resulted from an INLA strike against the nascent Irish branch of the Mafia, intended to prevent the organization from establishing a foothold in Tír criminal enterprises.

MacNamara Boys

This file, located in DS-17 of the TRC system, contains the information listed in **Legwork**, p. 62. However, the datafile on Nathair MacSweeney has been "suppressed by the authority of," followed by a long numeric code. If the runners cross-refer this code with the file on Dominic O'Brien in DS-14, they learn that he suppressed the data. Note that suppressed data is retained in hard copy only.

TRC Deckers

Every time the team decker crosses a node in the TRC system, roll 1D6. If the system is not in a state of alert, the team decker encounters a hostile TRC decker on a result of 1. If the system is on passive alert, he encounters a TRC decker on a result of 1 or 2. If the system is on active alert, he encounters a TRC decker on a result of 1, 2, or 3. Any time the team decker encounters a TRC decker, roll 1D6. On a result of 6, a second TRC decker appears.

For TRC deckers, use the game statistics for the Decker Archetype (p. 51, **SR11**) with the following modifications. All have Attack 6, Shield 2, and Mirrors 2 programs; their persona programs are all Rating 6; and all use Fuchi Cyber-7 decks with Level 2 response increase. The number of encounters with hostile TRC deckers is up to the gamemaster.

System Modifications

Feel free to substitute such programs as acid and jammer from the **Virtual Realities** sourcebook for some of the access/barrier IC in the system. Also, run this system like a video game: the team decker should have no time to think. Above all, balance is crucial. Although hacking the TRC matrix should be difficult, too tough a system may bog the game down by denying the runners vital information. The decker should ultimately gain the information, but have the ride of his life digging it up.

CIVIL DATABASES

The runners may deck into the registers of the civil aviation authority to check permits for chopper flights from Shannon Airport and into the land registry to check ownership of Altan Lodge. A successful Computer (4) Test gets a decker into those systems. If a decker gets into the aviation registry, give him the information on the Stallion from the Shannon Bridge Hotel system, listed on p. 47. By decking into the land registry, the decker learns that James Mairtin MacSweeney, a Derry elf currently out of the country, owns Altan Lodge. Although the shared surname may arouse the runners' suspicions, this elf is not related to Nathair. However, the gamemaster may develop this into a red herring if he wishes. Sculpted Environmental Systems Inc., a major Tír software corporation, has rented the property for a three-month period, but this information is not recorded in any system.

Shannon Bridge Hotel System

The Shannon Bridge Hotel matrix is a simple, straightforward system with minimal security. Of particular interest to the runners, the system contains important information on a helicopter charter to Boyle Abbey. If the runners access DS-2 in the Shannon Bridge system after 2:30, they find that Nathair MacSweeney booked a Stallion registered with serial number YHB-156722 for 7 on Day 4 of the MacNamara tour. According to the file, civil aviation authorities cleared a flight path to Boyle Abbey for the chopper. If the runners check details of aircraft ownership available in the public treuntas system, they find the Stallion registered to Dominic O'Brien.

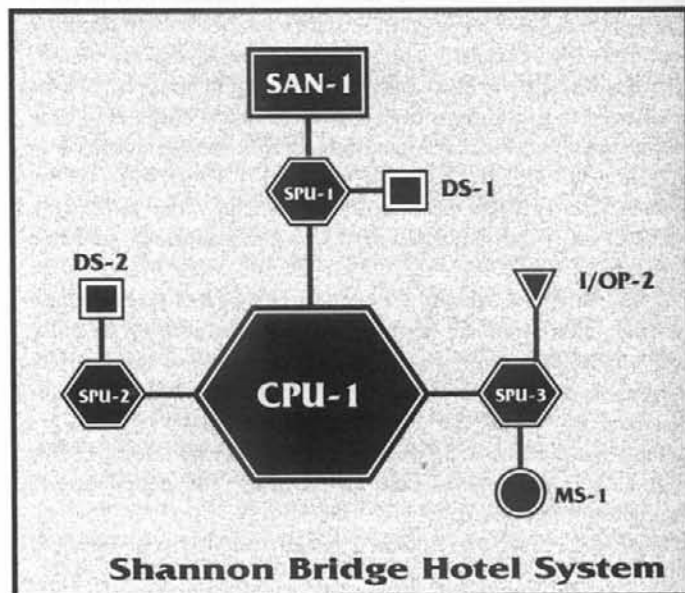



CPU = Central Processing Unit

DS = Datastore

I/OP = Input/Output Port

SAN = System Access Node

SM = Slave Module

SPU = Subprocessor Unit

SAN-1: Green-3, Access 3, Trace and Report 2. This node provides access to the hotel matrix.

CPU-1: Green-4, Access 4, Trace and Dump 4. This CPU provides power for the entire system.

SPU-1: Green-3, Access 3, Trace and Report 2. This SPU handles data flow from the Shannon Bridge system to the Matrix and supports the basic reservation database.

DS-1: This datastore contains all current reservations, as well as those made during the past six weeks. After 2:20, this datastore contains a record of the MacNamara entourage booking into an executive suite for one night.

SPU-2: Green-3, Access 3, Blaster 4. This SPU guards the datastore DS-2.

DS-2: This contains financial information on the hotel's service contracts, information on some of its local rivals, and a register of transport and special arrangements for guests. If the runners access it, they find the information on MacSweeney's 7 a.m. chopper to Boyle Abbey.

SPU-3: Green-2, Access 2, Trace and Report 2. This SPU controls the flow of information from the CPU to the SM-I/OP network linked to it.

I/OP-1: This port operates climate sensors in the hotel.

SM-1: This slave module contains control systems for the hotel's central heating, alarm systems, and the like.

FOREIGN DATABASES

Any time the group decks into a foreign database, increase their visible action tally by 1. If they make more than one separate run from the same Tír na nÓg location, increase the addition to the visible action by 1 each time: +2 for the second run, +3 for the third run, and so on. The TTG-SAN (national) security code is Red-5. If the runners hack into a non-Tír system for any reason, improvise a Quick Matrix system (p. 192, **SR11**) depending on what the runners are attempting to do.

One instance of decking into a foreign database needs special mention, however, because of the value of the data there. If the runners have learned that MacSweeney has links to Tír Tairngire and have also learned that he is related by marriage to Aithne Oakforest, a powerful Tír Tairngire official, they may try to penetrate Oakforest's matrix system. Because this development is so unlikely, Oakforest's personal system is not mapped here. Consult the **Tír Tairngire** sourcebook for basic information on the Tír Tairngire Matrix, or use the level of security and software described for the TRC system in this section as a guideline to how tough a decking job Oakforest's database poses. If the runners manage to crack it, they find confirmation of the blood relation between MacSweeney and the Tír Tairngire prince as well as several recent updates on MacSweeney. The database contains no detailed information on the Tír na nÓg operation or on the runners; however, it does contain a covert contact number for the INLA, data on MacNamara's Mafia ties, data on the Humanis Policlub membership of MacNamara's brother, and a chunky file on negotiations with Dominic O'Brien (see **Endgame**, p. 57). This information is worth a minimum of 100,000 nuyen.

GREEN HEAT

At some stage during the adventure, the Tír na nÓg authorities should catch up with the runners. This section describes the circumstances under which the runners may be apprehended by the Garda, by a TRC squad headed by Mairtin O'Neill (see **Cast of Shadows**, p. 70), or by both groups, and offers hints for running those various encounters. The gamemaster may use either the visible actions rules described below as a basis for triggering these encounters, or else devise them as he sees fit.

VISIBLE ACTIONS

As noted in **Don't Ask for Scotch**, p. 19, the visible action tally measures how much the runners have done to make themselves conspicuous and therefore determines how easily the authorities track them down. After 4 a.m. on Day 5 (see **Gamemaster Itinerary**, p. 21–2 of **Don't Ask for Scotch**), roll 4D6 for every hour of game time that elapses and also after any action taken that increases the runners' visible action tally. If the result is lower than the visible action tally, trigger an encounter with Garda officers (see **Garda Encounters**, below).

After the runners have lived through an encounter with the Garda, continue with the time- and event-based 4D6 rolls described above, but add 2 to the dice roll results. Whenever the modified results are lower than the visible action tally, trigger an encounter with Mairtin O'Neill's TRC squad.

Tailor these encounters to the times and locations in which they occur. For example, if the runners are out in open country, the TRC squad tries a simple ambush. If the runners are in a flat in town, the troopers smash down the door. If MacNamara lures the runners into a trap (see **Political Gambit**, p. 50), the TRC uses a well-planned ambush and extra personnel.

GARDA ENCOUNTERS

For Garda officers, use the game statistics listed for the Street Cop Contact (p. 211, **SR11**). Every Garda officer carries the following gear: AET NN-15 [Heavy Pistol, 25 (clip), SA, 9S(f)], Armor Jacket (5/3), Stun Baton (6S Stun). One member of every six-man Garda squad also carries an AET Dealanach Taser [4 (magazine), SA, 10S]. In encounters not triggered by the visible actions rules given above, Garda officers wear Armor Vests (4/3).

If the runners' visible action tally exceeds 10 and a Garda encounter occurs, the Garda has tracked down the runners but will not confront them. Instead, the Garda officers take a position to observe the runners and call in the TRC, who arrive in 3D6 minutes. This time gap gives the runners a chance to notice the Garda and either escape or try to neutralize them.

If the team's visible actions trigger the encounter, six Garda officers are present. In any other encounter, only two officers in a single Garda car appear. In any encounter, the Garda usually give some type of warning or challenge.

If the runners kill Garda officers, add 4 to the team's visible action tally. In addition, MacNamara can no longer get them out of Tír na nÓg (see **Political Gambit**, p. 50); only Dominic O'Brien remains able to do this (**Endgame**, p. 57). Instead of killing police officers, the runners may seek to escape a Garda confrontation by disabling the officers with non-lethal force, or they may surrender (see **Surrendering**, p. 49).

Note that the runners can also tangle with the Garda in encounters not dependent on the above rule system. For example, if the runners are speeding down a road, the Garda may give chase. In general, the runners do not tangle with the TRC in such incidental encounters.

TRC ENCOUNTERS

A TRC encounter is far more hairy than a Garda encounter. These hardened anti-terrorist commandos shoot first and ask questions later. Any TRC encounter includes a squad of four TRC troopers and a commanding *oifigeach*, Officer Mairtin O'Neill. For game statistics and background on O'Neill see **Cast of Shadows**, p. 170.

TRC Troopers (4)

B	Q	S	C	I	W	E	R	Armor
4	6	5	5	4	4	4	.025 (7)	5/3

Initiative: 5 (7) + 1D6 (3D6)*

Threat/Professional Rating: 5/4

Skills: Armed Combat 5, Etiquette (Military) 3, Etiquette (Street) 3, Firearms 7, Unarmed Combat 4

Cyberware: Beta-customized Boosted Reflexes (3), Smartlink

Gear: AET Dealanach Taser [4 (magazine), SA, 10S], AET NN-15 Heavy Pistol [25 (clip), SA, 9S(f), w/extra clip and Internal Smartlink], Armor Jacket (5/3), 2 Concussion Grenades (12M Stun), Defiance T-250 [Shotgun, 5 (magazine), SA, 10S, w/4 extra magazines], Metal Restraints, Respirator, Thermographic Binoculars

***Note:** Initiative values in parentheses refer to boosted reflexes.

COMBAT

Face it; with the subpar gear they probably have, the runners have virtually no hope of defeating the TRC squad in a stand-up fight. Their best chance for surviving a TRC encounter is to use magic to cover an escape or to surrender. Because Irish terrorists so rarely have magical power at their disposal, O'Neill and the TRC will not expect magic from the runners, and so the runners may be able to use it to get away.



O'Neill will accept a surrender at any point in combat unless the runners have killed any of his men. If they have, any battle becomes a shoot-out to the death. Initially, the TRC squad attempts to disable the runners with concussion grenades and the like, but if the runners do not surrender immediately, will quickly move on to heavy-duty attacks, including magic. See **Surrendering**, following.

If the runners somehow manage to kill or disable the TRC squad, the TRC activates two TRC officers, both Grade 6 Initiates of the magical Order of Cu Chulainn, to go after them. For these operatives, use Mairtin O'Neill's statistics, but raise the Magic Attribute to 12. The two officers are accompanied by eight regular troopers. This team finds the runners after 6D10 minutes. They have shoot-to-kill orders, and only intervention by Dominic O'Brien can possibly get the runners out of trouble.

SURRENDERING

Though this option may seem distasteful to the runners, it actually offers them their best chance for success. It also offers the gamemaster a chance to make players sweat through tense interrogation sessions.

If the runners surrender to the Garda, they are handcuffed and taken to the nearest Garda station. After 6D6 minutes, Mairtin O'Neill arrives to interrogate them. O'Neill separates the runners and interrogates them individually. The runners have no right to a lawyer, and O'Neill can hold them for as long as a week without bringing any charges against them. (See p. 42, **Tír na nÓg**.)

If the runners have killed any Garda officers, they receive a secret trial and are summarily executed as cop killers. If this happens, go to **Picking Up the Pieces**, p. 59.

If the runners have not murdered any Garda, they may be able to trade information for their freedom. To do so, they must convince O'Neill that they have information vital to the security of Tír na nÓg, and that this information must be acted on swiftly. Unless they make it clear that time is of the essence, O'Neill may simply decide he can interrogate the information out of them. Keep in mind that O'Neill can easily bring in a TRC mage to use an analyze truth spell or its equivalent on the runners; they cannot afford to bulldrek their way through.

This interrogation can go almost any direction, and so the gamemaster must improvise. No matter what, the runners must give O'Neill something useful. Dirt on MacNamara and the Irish Mafia is a great start, and the compromised data on O'Toole Transcom's Rosslare port does threaten Tír security. Any evidence

on Nathair MacSweeney helps to clear the runners of the terrorism charge, because only the elf knew that the Mafia meeting was to take place at Altan Lodge. In fact, he arranged it. The falsified personal history of the runner with the concocted INLA links (see **Red Haze**, p. 42) may make O'Neill skeptical. However, if that runner knows about that false history and protests his innocence, O'Neill leaves and returns after an hour with the following statement: "OK, you miserable slot, I'm satisfied that someone creatively altered your file in the recent past. Now, how should we go about getting to the bottom of all this, I wonder?"

If the runners do not know where Nathair MacSweeney has gone, O'Neill will tell them once they manage to convince him that they are not terrorists. In this case, O'Neill has seen the flight path filed for Dominic O'Brien's Stallion chopper, and offers the runners a deal. O'Neill sees O'Brien as the bad guy, but cannot launch an exploratory strike against Boyle Abbey without lengthy political haggling. Too many people and too much evidence might disappear while he is wasting time that way. However, the runners do not have that problem. Additionally, O'Neill's family does not get along with the O'Briens. By letting the runners hit the Boyle Abbey, Mairtin sees a chance to stymie shenanigans by a hostile Danaan-mór family, gain kudos within his own family ranks, and maybe even earn a promotion.

O'Neill proposes that the runners infiltrate Boyle Abbey at Lough Key and dig around. He even offers to supply them with some decent gear. However, because he wants to keep the body count as low as possible and make sure that the gear cannot be traced back to the TRC, his options are somewhat limited. He can rustle up three narcoject rifles, six concussion grenades, and a pair of stun batons stolen from the Garda by the INLA and subsequently recovered (for relevant game statistics, see p. 254, **SR11**). If the runners want to deck into the abbey's matrix system, O'Neill procures a Fairlight Excalibur and appropriate software to do so.

To ensure that the runners perform the mission, O'Neill fits each with a combined tracking signal and micro-transceiver ("Get them talking and we'll get everything on tape"). He also takes a small tissue sample from each ("Try to get clever and you'll be dead inside five minutes, understand?"). If the runners request it, O'Neill may arrange for a TRC mage to cast increase attribute spells and the like on the runners just before they hit the abbey. Once the runners are over the perimeter fence, however, they are on their own. (Go to **Plants with Attitude**, p. 52.) Finally, if the runners stole any data from the TRC system, it gets deleted from their cyberdeck. In return for the runners' services, O'Neill promises to keep the TRC off their tails so that they can escape from Tír na nÓg.

Wimping Out

The runners may decide at an early stage in their fugitive career to turn themselves in to the authorities and spill what they know of events at Altan Lodge. Runners being runners, this is unlikely. If they surrender early, without waiting for an encounter with law enforcement, the authorities give them to Mairtin O'Neill for interrogation. At this stage, however, the runners are unlikely to know about the forged personal file in the TRC system, and so O'Neill will probably believe that they are all terrorists. The TRC quickly assembles its case against them, and the runners receive a secret trial. If this happens, go to **Picking Up the Pieces**, p. 59.

POLITICAL GAMBIT

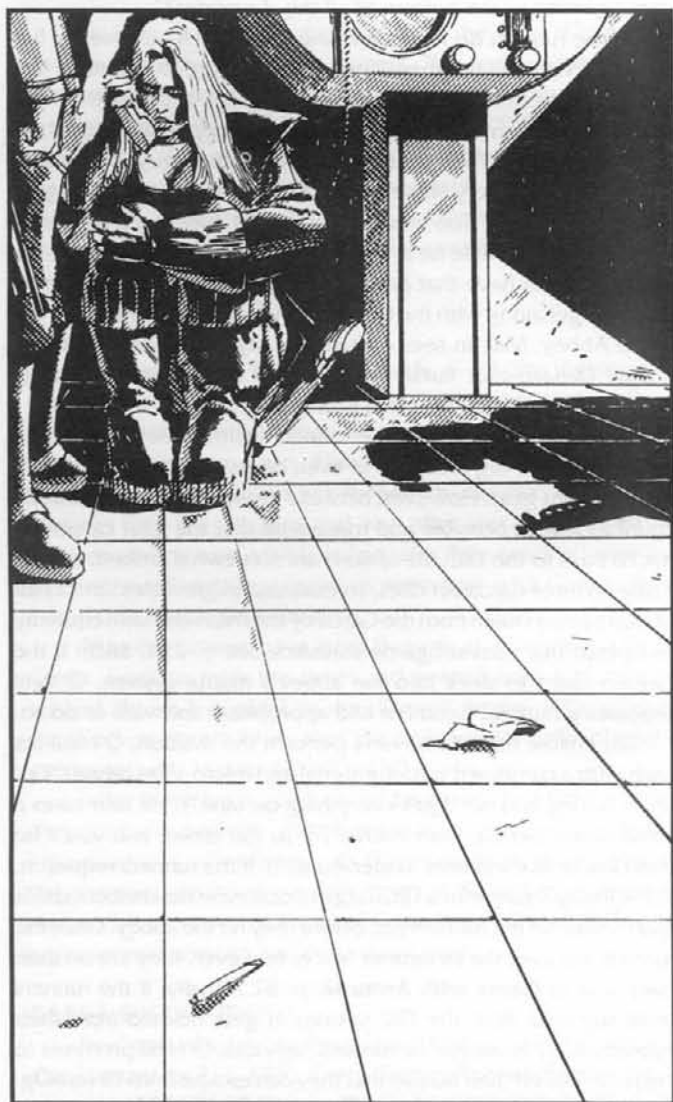

TELL IT TO THEM STRAIGHT

You've got some drek on the MacNamara entourage, and it seems like a good idea to cash it in right about now. In exchange, you just want to get out of Tír na nÓg and back home safely, surely a reasonable enough desire. You don't trust MacNamara farther than you can throw a piasma, but he'll have to help if he knows that otherwise you'll leak the drek you've got to the voting public. He will, won't he, chummers? Your anxiety verging on panic, you punch a number into the telecom.

BEHIND THE SCENES

In this encounter, the runners have several options for negotiating with MacNamara to effect their escape from the Tír. Feel free to modify the introductory text above, depending on how much the runners know and the circumstances surrounding their attempt to broker a deal.

Four pieces of information may enable the runners to strike a deal with MacNamara. First, they may know that MacNamara had Mafia links in his early days in New York. They may also know that the meeting at Altan Lodge involved the Mafia's small Irish branch. The group may also know that the Mafia is the major foreign smuggler of controlled items into the Tír. Finally, the runners may know that MacNamara's negotiators provided plans of O'Toole Transcom's Rosslare cargo-transfer facilities to the mobsters at Altan Lodge.

Put together, these items clearly indicate a MacNamara-Mafia link. The runners can always pretend to know more than they do, but that poses risks. Once they have told MacNamara what they know, the runners may threaten to notify O'Toole Transcom and the Tír government, and/or blow the story to the New York media. If the runners play this hand well, MacNamara agrees to get them out of the Tír.

The runners may also know that MacNamara's brother was once a member of the Humanis Policlub, but this does not worry MacNamara much. He has gotten used to fending off this accusation. If the runners use this ploy first, MacNamara believes they have nothing important on him; to reflect this, add 1 to all target numbers for tests the runners make when dealing with him.

The runners may also hint that they have interesting information on Nathair MacSweeney, and offer to tell MacNamara what has been going on behind his back. However, this offer alone is not enough to make MacNamara deal; it simply makes the negotiating easier.

Finally, the runners may tell MacNamara, "Hey, if we were *really* in with terrorists, we'd have helped them more directly. We could have given them clean shots at you in a dozen places, right? So why would we frag around with the meet at the lodge?" If the runners try anything like this, it makes sense to MacNamara; subtract 1 from the target numbers of all tests they make during subsequent dealings with him.

To finalize the deal, the runners must set up a meeting at a safe place. After all, MacNamara has to hide them from the Garda and TRC somewhere and get them out of Tír na nÓg on a private plane. The gamemaster should let the runners choose a suitable location, using the appropriate Location Archetype from **Sprawl Sites**.



MEETING MACNAMARA

If the runners contact MacNamara, he agrees to a meeting whether he intends to deal honestly with them or not. The first time they speak with him, he only agrees that a deal is possible. During the first actual meeting, he agrees to get the runners out of the Tír in exchange for their silence. He does not let the runners extort money from him and refuses to agree to any extravagant demands. He says he must have six hours to pull the political strings in order to get the runners the proper clearance out of Tír na nÓg and arrange for a private jet to fly them from Shannon or Dublin Airport back to New York. MacNamara cannot break his public engagement schedule to meet the runners, because this would attract suspicion. However, he can meet them during a lunch break or other down time.

If the runners have killed any Garda and/or TRC men, Nathair MacSweeney will have informed MacNamara by the time the runners contact him. In this case, MacNamara notifies the authorities and the runners find their private jet stuffed full of TRC commandos. The TRC force overwhelms the runners, who receive a secret trial and death sentences for their supposed crimes. MacNamara cannot get the runners out under these circumstances; his only hope for political survival lies in cooperating with the Tír authorities, who in return agree to suppress evidence on his behalf. If the runners have left little "Open-this-if-I'm-not-back-by-Thursday" packages on bulletin boards back home, MacNamara simply hopes that no one will believe a bunch of cop-killing, terrorist sympathizers.

If the runners manage to persuade Bridgit O'Toole to contact MacNamara, however, he accepts the deal. To persuade Bridgit, a runner must make a successful Charisma (10) Test. If the test is

successful, Bridgit says, "Mr. MacNamara, I'm *most* concerned about the careless way certain details of my family's installation were left lying around, and I'm *so* grateful that certain members of your entourage are planning to return them. I trust you will reward them accordingly?" Unwilling to risk any disagreement with the daughter of a Danaan-mór prince, MacNamara gets the runners out of the Tír (see **Picking Up the Pieces**, p. 59).

Under any other circumstances, the runner doing the talking with MacNamara must make a Negotiation (8) Test. If the runners have dirt on MacNamara's retinue, reduce the target number by 1 or 2 as seems appropriate. Reduce by 1 again if they have information on MacSweeney's treachery, and by an additional 0-2 depending on how well they roleplay the negotiation. If the test is successful, MacNamara gets the runners home; it is difficult for him to pull strings in Tír na nÓg, but he can barely manage it if he strews around a lot of future favors. If the test is unsuccessful, MacNamara double-crosses the runners and does his best to hand them over to the Tír authorities. As with the situation where the runners have killed police, MacNamara arranges a plane for the group full of TRC commandos who capture them when they board.

If MacNamara plans a double-cross, the runners may learn about it from Petra Johnson or by decking into the TRC system, where details of the ambush are entered into the ongoing operations datastore. Both of these options are slim chances; the TRC system is tough to crack (see **Red Haze**, p. 42) and Petra is unlikely to have heard MacNamara's plans. If MacNamara lets the runners down, a confrontation with MacSweeney becomes their only hope for escaping the Tír (see **Plants with Attitude**, p. 52).

If the runners successfully make a deal with MacNamara, go to **Picking Up the Pieces**, p. 59. If they plan to confront MacSweeney, go to **Plants With Attitude**, p. 52.

PLANTS WITH ATTITUDE

TELL IT TO THEM STRAIGHT

Gamemaster's Note: This encounter assumes the runners get to Boyle Abbey after 6:25 a.m. on Day 5, when Nathair MacSweeney's chopper arrives from Shannon. If they arrive before this time, the gamemaster must adapt the text to suit the situation.

Nathair MacSweeney must be the key to the drek you're in. That dandelion-eater is one slippery customer. If he's hiding out at Boyle Abbey, the corporate HQ of Sculpted Environmental Services Inc. (SES), then he must have powerful friends. You don't know why he's tried to fit you up for an Irish body bag, and ideally you'd like to blow his head off shortly after ripping his lungs out. But if you're going to get out of Tír na nÓg alive, you're going to need some powerful help, and this pointy-eared Judas may be your only real hope.

BEHIND THE SCENES

Nathair MacSweeney and Dominic O'Brien are deep in discussion about some such highfalutin' drek as philosophy, politics, elven bloodlines, reincarnation theory, and so on. Though they do not expect the runners to turn up, the elves seem curiously unconcerned when the runners arrive.

MacSweeney does not care whether the runners get blown to pieces by security outside the abbey or manage to get through to O'Brien and himself, arrogantly believing that he and O'Brien can easily handle the runners if they get violent inside the abbey. O'Brien has given him some extra information on MacNamara that will enable MacSweeney to ruin MacNamara whether the Mob link blows up into a horrible mess involving the runners or not, so MacSweeney feels on top of the world.

However, because O'Brien does not know the full details of MacSweeney's manipulations of the runners, he would rather explain the situation to them than kill them. He is even willing to help them out of the country, provided they do not try to kill him. In general, O'Brien prefers not to think too much about the runners. He has aided MacSweeney by placing the false terrorist link in the runners' TRC files, but he believes the runners' deaths would be MacSweeney's karma problem, not his.

BOYLE ABBEY

To reach MacSweeney and O'Brien, the runners must get past Boyle Abbey's extensive security measures. Security personnel, all elven, are the most obvious obstacle, but the abbey grounds also contain hostile flora and fauna. The abbey itself has a forbidding security system, but if the runners can hack into the abbey matrix

and disable the security system's sensors, alarms, and weapons, they can defeat it.

The runners may plan to ambush MacSweeney, subdue him and use him as a hostage, or take him off for solitary interrogation, and so on. The following description of the abbey's location, as well as the approaches MacSweeney and Dominic O'Brien use in negotiations (see **Endgame**, p. 57), should provide an adequate basis for improvisation.



Boyle Abbey Grounds

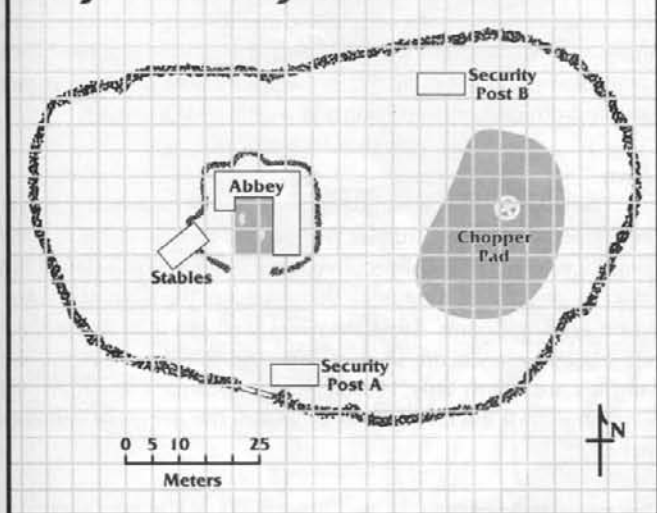

Hedge Barrier

A 3-meter tall, 1-meter thick hedge surrounds the abbey. This dense, thorned mass forms a Barrier 14 against vehicle attacks and also a magical Barrier Rating 5 (see p. 98, **SR11**). If any runner touches the hedge, its thorny tendrils and shoots wrap around the runner's torso and limbs and the plant tries to inject a sedating poison into the runner's body. A successful Quickness (8) Test enables a runner to avoid its grasp. If caught, however, a runner needs to make a successful Strength (6) Test to escape. If the test is unsuccessful, the runner may repeat it once per turn to free himself. In addition, a runner caught by the hedge must make a successful Body (6) Test each turn he is trapped to avoid the effects of the hedge's venom. If the player character is wearing impact armor, subtract half its rating from the target number and round fractions down. If the test is unsuccessful, the runner loses 2 points from his Strength, Quickness, and Reaction Attributes for 6D6 turns. The plant is unaffected by mana spells; a fire-based spell, however, destroys the entire hedge within the spell's area of effect.

Security Gates and Posts

Metal security gates form a Barrier 20 against vehicles and a Barrier 7 against bullets. Two of the security men stationed at Security Post A always keep watch at the gate and check all visitors. Security Post A also contains a computer terminal, from which the runners can access the abbey's matrix system.

Each security post has a total of five elven security personnel: four guards and a mage. The mage sleeps between 8 a.m. and 4 p.m., and usually remains in the security post the remaining time. To determine whether or not the mage is at his post, roll 1D6: if the result is 6, he is in the abbey taking a meal, consulting the library, and so on. Each security post also houses two huge Irish wolfhounds. These animals attack intruders ferociously when commanded by their handlers. Any sign of trouble at either security post prompts one of the security guards to activate a general alarm at the security desk within the abbey.

Bluffing past the security guards at the gates is impossible. These elves always check with Dominic O'Brien in person before admitting anyone, and they immediately dismiss anyone not on their list of arranged visitors. Fanatically loyal to O'Brien, the guards do not accept bribes; however, a normal automobile driving up to the gate does not prompt the guards to alert security inside the abbey. Passing themselves off as lost tourists or the like might enable the runners to get close enough to the post to disable the guards.

Security Guards (8)

B	Q	S	C	I	W	E	R	Armor
4	5	5	5	3	4	4.95	4 (5)	5/3

Initiative: 5 (6) + 1D6 (2D6)*

Threat/Professional Rating: 4/3

Skills: Armed Combat 5, Etiquette (Military) 3, Etiquette (Street) 3, Firearms 7, Unarmed Combat 4

Cyberware: Beta-customized Boosted Reflexes (2), Smartlink

Gear: AET Dealanach Taser [4 (magazine), SA, 10S], AET NN-15 [Heavy Pistol, 25 (clip), SA, 9S(f), w/extra clip and Internal Smartlink], Defiance T-250 [Shotgun, 5 (magazine), SA, 10S, w/4 extra magazines], Metal Restraints, Respirator, Stun Baton [Reach 1, 6S Stun], Thermographic Binoculars

*Note: Initiative values in parentheses apply to Boosted Reflexes.

CONDITION MONITOR	
	LIGHT STUN MODERATE STUN SERIOUS STUN DEADLY STUN
STUN	1 2 3 4 5 6 7 8 9 10 11 12
PHYSICAL	1 2 3 4 5 6 7 8 9 10 11 12

CONDITION MONITOR	
	LIGHT STUN MODERATE STUN SERIOUS STUN DEADLY STUN
STUN	1 2 3 4 5 6 7 8 9 10 11 12
PHYSICAL	1 2 3 4 5 6 7 8 9 10 11 12

CONDITION MONITOR	
	LIGHT STUN MODERATE STUN SERIOUS STUN DEADLY STUN
STUN	1 2 3 4 5 6 7 8 9 10 11 12
PHYSICAL	1 2 3 4 5 6 7 8 9 10 11 12

CONDITION MONITOR	
	LIGHT STUN MODERATE STUN SERIOUS STUN DEADLY STUN
STUN	1 2 3 4 5 6 7 8 9 10 11 12
PHYSICAL	1 2 3 4 5 6 7 8 9 10 11 12

CONDITION MONITOR	
	LIGHT STUN MODERATE STUN SERIOUS STUN DEADLY STUN
STUN	1 2 3 4 5 6 7 8 9 10 11 12
PHYSICAL	1 2 3 4 5 6 7 8 9 10 11 12

CONDITION MONITOR	
	LIGHT STUN MODERATE STUN SERIOUS STUN DEADLY STUN
STUN	1 2 3 4 5 6 7 8 9 10 11 12
PHYSICAL	1 2 3 4 5 6 7 8 9 10 11 12

CONDITION MONITOR	
	LIGHT STUN MODERATE STUN SERIOUS STUN DEADLY STUN
STUN	1 2 3 4 5 6 7 8 9 10 11 12
PHYSICAL	1 2 3 4 5 6 7 8 9 10 11 12

CONDITION MONITOR	
	LIGHT STUN MODERATE STUN SERIOUS STUN DEADLY STUN
STUN	1 2 3 4 5 6 7 8 9 10 11 12
PHYSICAL	1 2 3 4 5 6 7 8 9 10 11 12



the windows for a period of 5D6 turns. If a window is smashed during this time, the liquid layer reacts with air to form an acidic vapor that inflicts 5S damage on anyone within three meters of it. Runners may resist the damage with a successful Body (5) Test. Each success reduces the Damage Level by 1. Heavy drapes behind all the windows prevent the gas from affecting anyone inside the building.

INSIDE THE ABBEY

Boyle Abbey itself contains three important locations: the security desk, the library containing the abbey's computer system, and the suite of rooms where MacSweeney and O'Brien are ensconced. The abbey map (p. 56) shows other rooms such as bedrooms and lounges, but these should not enter into play. Once inside the abbey, the runners must deal with security, deck into the matrix system, and ultimately confront Nathair MacSweeney and Dominic O'Brien. If the runners get through all the opposition, O'Brien and MacSweeney are waiting for them. Go to **Endgame**, p. 57.

Security

One security guard mans the security desk at all times; two other guards and a security mage cover the bedroom suite and lounge. Use the profiles given under **Security Gates and Posts**, p. 53, for these elves.

Any time an alarm is triggered at the security desk one of these security personnel attempts to sound a full alert. This requires a Simple Action. Once this occurs, the runners have exactly three minutes before a squad of 12 security men and 3 security mages arrive from elsewhere in Lough Key. For game statistics, use the profiles given under **Security Gates and Posts**, p. 53. The additional security carry NN-22 SMGs (equivalent to HK-227s) in addition to the gear listed in the above-mentioned statistics.

Abbey Matrix System

Boyle Abbey's matrix system is simple, and security levels are not excessively high outside of the CPU and the datafiles holding research data.

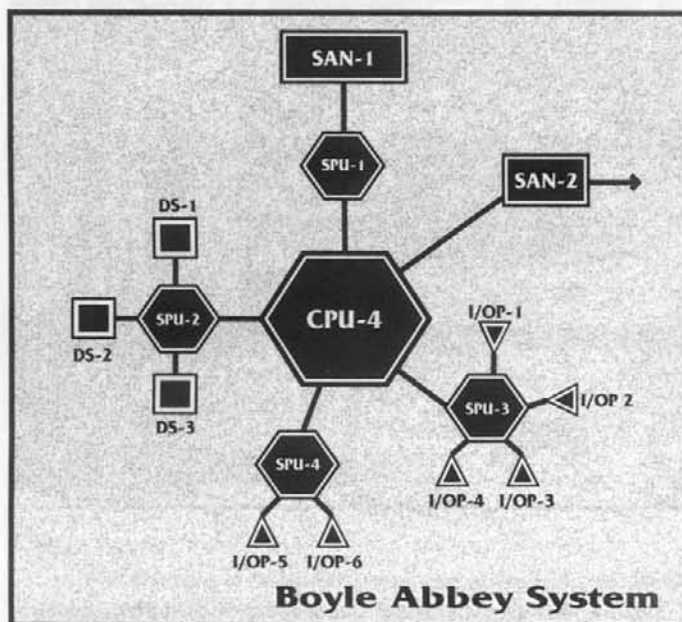
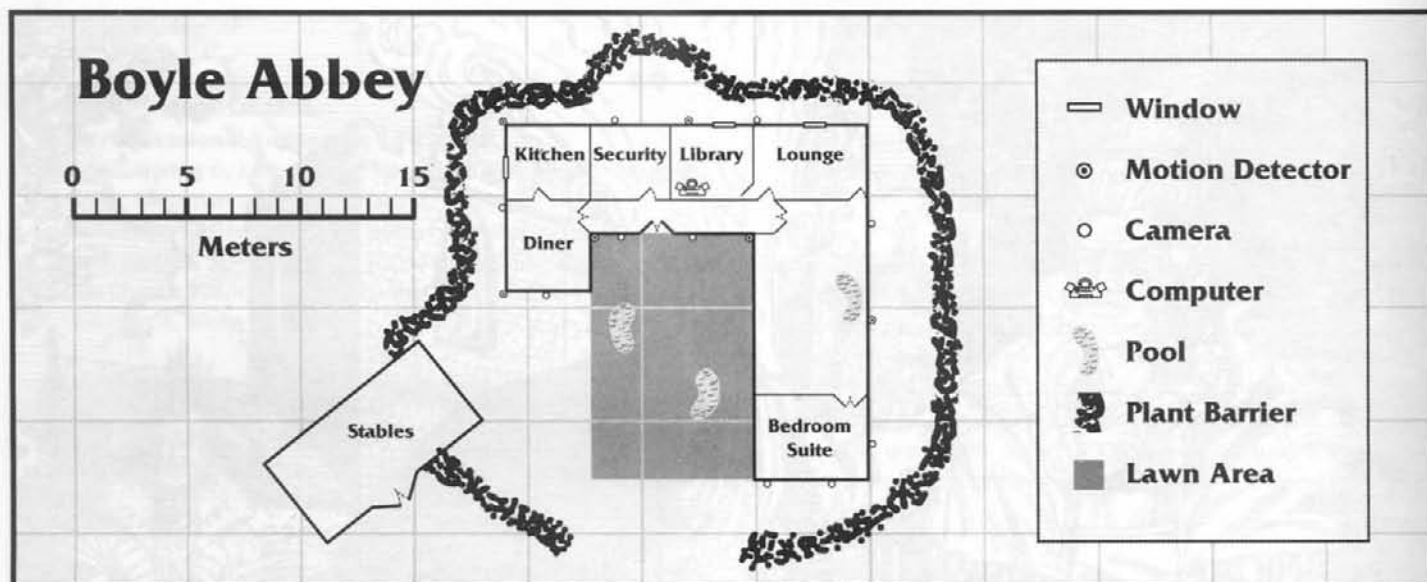

CPU = Central Processing Unit
DS = Datastore
I/OP = Input/Output Port
SAN = System Access Node
SPU = Subprocessor Unit

SAN-1: Red-3, Access 5, Barrier 5, Trace and Report 5. This SAN provides access to the abbey matrix.

SAN-2: Red-3, Access 5, Barrier 5, Trace and Report 5. This SAN provides access to other elements of the SES system. The remainder of the system contains nothing of relevance to the adventure; if the deckers wander off down the datalinks, the gamemaster must improvise additional elements of the system.

CPU-1: Red-4, Access 6, Trace and Burn 6. This CPU provides the horsepower for the entire system.

SPU-1: Red-3, Access 5, Trace and Burn 5. This SPU guards access to CPU-1.

SPU-2: Red-4, Barrier 5, Tar Pit 5. This SPU guards access to sensitive datafiles in the system.

DS-1: Green-4, Access 5, Trace and Report 4. This datastore is an archive of international journal abstracts on parobotany and parazology.

DS-2: Red-3, Access 6, Trace and Report 5. This datastore holds Dominic O'Brien's personal research notes, which resemble a gigantic clipboard more than organized research files. They are too haphazard to be of great value.

DS-3: Red-3, Access 4, Barrier 3, Tar Baby 4. This datastore contains abstracts of recent research reports to Dominic O'Brien from other SES operatives. Because the abstracts are in condensed form and contain little detail, the value of the 15 Mp of data is only 5,000 nuyen.

SPU-3: Red-3, Barrier 4, Blaster 4, Trace and Burn 4. This SPU handles the security systems around Boyle Abbey.

I/OP-1: Red-2, Barrier 4, Blaster 4. This port accesses the motion detectors.

I/OP-2: Red-2, Barrier 4, Blaster 4: This port controls the gas-emission devices on the motion detectors.

I/OP-3: Red-2, Barrier 4, Blaster 4: This port accesses window sensors that activate alarms break-ins occur.

I/OP-4: Red-2, Barrier 4, Blaster 4: This port accesses the security cameras.

SPU-4: Orange-4, Access 5, Tar Pit 4. This subprocessor handles the various terminals around Boyle Abbey.

I/OP-5: Orange-4, Access 4, Trace and Report 4. This port handles data to and from the security desk inside Boyle Abbey.

I/OP-6: Orange-4, Access 4, Trace and Report 4. This port handles data to and from the security posts on the perimeter.

ENDGAME

TELL IT TO THEM STRAIGHT

Electronically sealed doors open slowly, letting you look down a long, carpeted corridor. The huge room beyond contains a marble pool, wall hangings of silk and satin, and a riot of plant life in golden, cauldron-shaped vases and bowls. Two elves rise to their feet to look at you. One you recognize as Nathair MacSweeney. The other looks middle-aged; he has gray in his hair and a widow's peak above his piercing blue eyes. He wears cloud-gray robes trimmed with dark blue and covered with tiny embroidered cauldrons. The thick staff he holds screams magic at you. The scents of rose and neroli rise from a steaming cauldron beside the pool. MacSweeney holds a spell focus in one hand and a Remington Roomsweeper in the other; he's crouching down, watching you with narrowed eyes. The other elf, calm and arrogant, waves his staff at you and commands, "Enough bloodshed. Lay down your weapons; I wish you no harm."

Well, chummers, trick or treat? You want to scrag these slots now, or do you want to talk first?

BEHIND THE SCENES

Nathair MacSweeney has gotten everything he wants from the MacNamara business. His Tir Tairngire contacts have given him additional evidence of MacNamara's entanglement with the Mafia, and he knows he can destroy the man. He has set up negotiations between O'Brien and Aithne Oakforest, MacSweeney's princely relative, as well. Now he wants to return home, pocket a fat fee for his diplomatic services, slip his inside dope to the media and watch them rip MacNamara to pieces. To him, the runners are an annoying loose end. Ideally, MacSweeney would like to see them dead, but as long as they keep quiet about events in Tir na nÓg, he does not care what happens to them.

Though O'Brien is not directly concerned with the runners, he may come to realize that MacSweeney has fragged them over. As this encounter begins, however, he believes that one of the runners has links with the INLA, because MacSweeney presented him with falsified evidence that O'Brien took as true and inserted into the TRC database. Though suspicious of them, he is also curious: he is prepared to talk and to listen if the runners do not attack him.

NEGOTIATIONS

If the runners opt to talk, they will more than likely want to know what the frag has been going on. MacSweeney tries to placate them, but offers as little information as possible. O'Brien says even less.

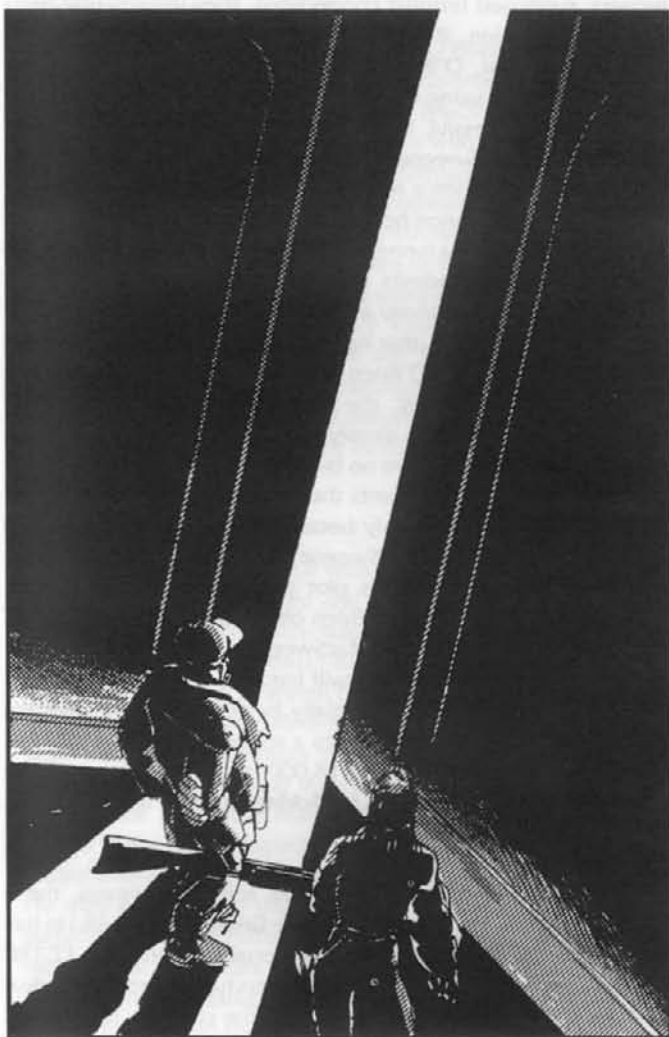

Using those portions of the truth most advantageous to him, MacSweeney says he wanted to discredit MacNamara because the man is a racist and a criminal. He pleads his case emotively and well. According to MacSweeney, the Altan Lodge attack was designed to produce a furor that would sink MacNamara; the evidence MacSweeney already had of MacNamara's Mob ties was not strong enough to bring MacNamara down. When the events at Altan Lodge become known back in New York—and MacSweeney will make sure they do—they will spell the end for MacNamara. If at any point earlier in the adventure the runners have observed MacNamara's anti-elven bias (see **Don't Ask for Scotch**, p. 19) they may be inclined to buy at least part of his story.

Having heard MacSweeney out, the runners may reasonably ask whether there was not some easier way to get MacNamara. To this question, MacSweeney repeats that his evidence did not suffice at the time. He needed more, and fast, to make sure MacNamara lost the impending mayoral election. If the runners ask MacSweeney why he framed them, MacSweeney shrugs and says he needed a plausible scapegoat for the attack.

At this point, O'Brien starts sympathizing with the runners, becoming a bit disdainful of MacSweeney. If O'Brien brings up the runners' supposed terrorist connections, they vehemently deny any such affiliation. If one of the runners makes a successful Charisma (6) Test, O'Brien believes the runners and turns on MacSweeney, accusing the elf of giving him false information. If the test is unsuccessful, O'Brien accepts the runner's claim, but considers that MacSweeney made an honest mistake about them.

Whatever O'Brien's reaction, MacSweeney claims that he believed the information he gave O'Brien to be inserted into the TRC matrix system. If a runner makes a successful Interrogation (6) Test, MacSweeney admits that he suspected the information might have been "creatively amended." He resists to the last any suggestion of the truth, that he fabricated it himself.

If the runners ask O'Brien and MacSweeney why they are meeting at Boyle Abbey, the elves refuse to speak of their discussions. O'Brien says simply that they are discussing elven affairs that the runners have no business knowing about.

Ultimately, O'Brien wants the runners to keep quiet about events in Tír na nÓg, simply because he does not want to be associated with them. MacSweeney wants them to stay quiet because they can expose his plot to discredit MacNamara. In exchange for their silence, O'Brien offers to arrange the runners' safe departure from the Tír. MacSweeney sweetens the pot by pointing out that MacNamara will hardly pay them now, so he offers to make up the shortfall. Initially, he offers the same payment Wassall did, but if a runner makes a successful Bargain (4) Test, MacSweeney raises the fee to 18,000 nuyen per runner. If the runners agree to the deal, go to **Picking Up the Pieces**, p. 59.

TRC Connection

Of course, if Mairtin O'Neill has sent the runners, these negotiations may be very different (see **Green Heat**, p. 48.) In this case, Mairtin's TRC squad, with additional support from 12 TRC troopers, enters the abbey after the runners have negotiated a deal and arrest Nathair MacSweeney. For game statistics for the TRC troopers, use those given in **Green Heat**. Having heard all that passed between the two elves and the runners, Mairtin feels he has enough to nail MacSweeney, who is hauled off in restraints. O'Neill and O'Brien then look at each other meaningfully; apparently, some serious elven family repercussions will follow the denouement at Boyle Abbey. Go to **Picking Up the Pieces**, p. 59.

If the runners tell O'Brien about their TRC contact when they first enter the abbey, O'Brien demands the name of the TRC officer. If they tell him, he retires to make one or two sensitive phone calls. He then returns, saying the matter has been resolved; the runners need not worry about the TRC as long as they never return to Tír na nÓg. O'Brien deals with the DNA samples O'Neill took from the runners; until the samples are destroyed, they must stay with O'Brien under his protection from ritual sorcery.

DEBUGGING

If the runners attack Dominic O'Brien and Nathair MacSweeney, they are dead meat. O'Brien conjures water elementals from the ponds outside the abbey, and uses his spells and cauldron focus to the utmost. If the runners choose this foolish option, the gamemaster should pull no punches.

If the runners fail to defeat Boyle Abbey's security and never confront the elves, they can still cut a deal with MacNamara (**Political Gambit**, p. 50) unless they have been sent to Boyle by Mairtin O'Neill. In the latter case, they just blow out; for details, go to **Picking Up the Pieces** p. 59.



PICKING UP THE PIECES

This adventure may end in four possible outcomes. First, the runners may fail to leave the Tír alive. Alternatively, the runners may get out of the Tír by cutting a deal with MacNamara (**Political Gambit**, p. 50), Dominic O'Brien (**Endgame**, p. 57), or Mairtin O'Neill (**Green Heat**, p. 48).

IF THE TEAM FAILS

If the runners have killed any Garda or TRC officer, they receive a secret trial as suspected terrorists followed by summary executions. End of career, chummer.

If the runners go to the authorities immediately after the strike against Altan Lodge, hoping that the truth will set them free, they are dragged up. The authorities accuse them of complicity in the terrorist strike; after the inevitable secret trial, they hand the runners 2D6-year prison terms. Have fun in the slammer!

IF THE TEAM SUCCEEDS

In this adventure, success means survival. As long as the runners make a deal with someone to get out of the Tír, they have succeeded. To what extent and what other consequences they suffer depend on who they cut the deal with.

DEAL WITH THE MAN

If MacNamara gets the runners out of Tír na nÓg, Nathair MacSweeney dies in an unfortunate accident shortly after the entourage arrives Stateside and before the elf can contact the media. Of course, MacNamara wins the upcoming election.

If the runners stay quiet about what happened overseas, MacNamara may decide to keep them on his payroll. After all, they are unlikely to destroy a meal ticket, right? MacNamara deals with the runners fairly, because he fears that they just might have evidence stashed away that could expose him. Though he had the same problem with MacSweeney, the elf had become so dangerous to him that he felt he had to take a chance on geeking him.

MacNamara gives the runners jobs that immerse them in criminal dealings, figuring that the best way to protect himself against any future accusations is to discredit the runners in advance by associating them with criminals or having them die on a run. This means that the runners can look forward to steady, highly paid, but distasteful work. Whether they want to go this route depends on how readily nuyen dissolves their scruples. Think Watergate, Irangate, and so on. They may well go for it; MacNamara has a shot at becoming UCAS president, after all, and presidential pardons have become quite common in recent years.

ELVEN CONCORD

If the runners arrive at a deal with O'Brien and MacSweeney (**Endgame**, p. 57), they can gain further commissions from O'Brien. They almost certainly will not trust MacSweeney ever again. O'Brien, however, has extensive links with elves outside the Tír aside from Aithne Oakforest and Tír Tairngire, and could certainly use trustworthy runners for foreign operations. His major needs are economic espionage, especially involving ecological data, and covert operations against anti-elven interests (Humanis and the like). A powerful elf, O'Brien has plenty of nuyen and access to extremely high-tech gear. If the runners go this route, they become spies in the service of the Tír. O'Brien may even be prepared to lease them to a Tír Tairngire noble for subcontracted, covert operations. They could become rich doing this; but then again, they may have had their fill of elven intrigue and decide it is not worth the headaches.

POLICE INFORMANTS

If the runners cut a deal with Mairtin O'Neill and succeed in facing down MacSweeney and O'Brien, they make a serious enemy of the O'Brien family, which may decide to exact revenge. Because the O'Briens realize the jam the runners were in, their revenge should not be lethal; however, some kind of retribution is required to save face. Rather than having the runners killed, the O'Briens prefer to see them merely mutilated or disabled for life, plunged into poverty and their reputations ruined.

On the plus side, Mairtin O'Neill can always use foreign agents in the UCAS, especially ones based in New York, Massachusetts, or any other area with a large Irish-American population. He may offer to pay the runners to spy on and strike against supporters of INLA terrorism and Humanis policlubs and to keep tabs on human visitors from Tír na nÓg to UCAS who might be engaged in fundraising for the INLA. Though TRC work would pay them well, it would also require the runners to be fitted with cortex bombs. The runners are foreigners, after all, and many of them may be non-elves. Therefore, they are inherently untrustworthy from a Tír elf's point of view.

The runners may even be able to combine this ending with a deal with MacNamara. With MacSweeney arrested, the runners could easily return to MacNamara and finger MacSweeney as the real traitor. Also, the runners can use any dirt they have on MacNamara as leverage in a blackmail scheme. MacNamara will stall the runners if they try this, however, because he suspects the TRC may actually expose his Mafia links and cost him his O'Toole connection. Because he cannot be sure the TRC will expose him, if the runners make a successful Bargain (4) Test, he tries to buy them off. Use 50,000 nuyen as a base price for these negotiations.



If the runners go this route, MacNamara does not keep them on retainer. Instead, he hires agents to track down any recorded, stored versions of the dirt the runners have on him and then has the team geeked. Making an enemy of the future mayor of New York (and potential president of UCAS) is not a wise move.

If the runners blow out at Boyle Abbey and go back to O'Neill confessing failure, the gamemaster has two options. If he feels mean, O'Neill kills the runners for "resisting arrest." If the gamemaster feels benevolent, O'Neill forces the runners to act as cortex-bombed foreign spies for as long as he wants.

O'TOOLE CONNECTION

Because the runners get smuggled out of Tir na nÓg quickly by anyone they cut a deal with, they have little chance to firm up any relationship with Bridgit O'Toole. If they based most of their operations from an O'Toole Transcom base, however, Bridgit may not get bored with her new, exciting romantic interest for, oh, a week or two. The gamemaster may wish to base a future run on an O'Toole commission; however, this becomes unlikely if the runners are already in the service of O'Neill. He will claim first priority on their services in the councils of the Danaan-mór.

AWARDING KARMA

Award Team Karma as shown below. Round fractions up.

TEAM KARMA

Intelligent legwork and downtime actions before Altan Lodge debacle (gamemaster's discretion)	1
One runner establishes a romantic relationship with Bridgit or Padric O'Toole	1
The runners befriend Petra Johnson	1
The runners find dirt on MacNamara's retinue	1-2
The team locates TRC system data on falsified terrorist background	1
The team strikes a deal with MacNamara to leave Tir na nÓg	0*
The team strikes a deal with O'Brien to leave Tir na nÓg	3*
The team strikes a deal with Mairtin O'Neill to leave Tir na nÓg	3*

*Save for the MacNamara/O'Neill deal described under **Police Informants**, above, these three outcomes are mutually exclusive. If the runners make this combined deal, the team receives no Karma for the deal with MacNamara.

INDIVIDUAL KARMA

Award individual Karma per p. 199, **SRII**. Particular points of importance for awarding individual Karma are the runners' dealings with Petra Johnson and Bridgit or Padraic O'Toole.

JP
93

LEGWORK

CONTACTS

To follow up on or investigate clues in this adventure, the player characters need to investigate people, places, and situations. One of the best ways to do this is through contacts.

The runners are likely to use contacts in two ways in **Celtic Double-Cross**. First, they may touch base with their contacts before they leave for Tír na nÓg. They are likely to get little info at that point in time, however. James Wassall is the only entourage member they know at that stage, though they may learn that Patrick MacNamara is their employer and do some digging on him.

They may also phone their Stateside contacts once they reach Tír na nÓg; by then they will know the names of all the entourage members. **When the Smoke Clears**, p. 32, includes rules for phoning contacts and for using the special "hot information" contacts may provide.

Each subject entry in this section lists appropriate contacts for questioning about a given subject. To find out what a contact knows, a player must make an Etiquette Test against the target number listed in the entry. The tables in each entry describe the particular information that each number of successes elicits from the contact. Players who achieve multiple successes gain all the information available to all previous levels of success.

As a result of their down-time activities, the runners may establish contacts in Tír na nÓg other than Bridgit or Padraic

O'Toole. Because these encounters are improvised by the players, the gamemaster determines what specific information these additional contacts can provide. In broad terms, these contacts know little or nothing about MacNamara and his retinue, though they might have information about Tír citizens.

HOT INFORMATION

The gamemaster should not be too generous with the "hot information" in the following entries, especially if he suspects the runners will not keep promises they make to get it. Furthermore, he should withhold "hot information" as long as the runners remain in the UCAS. This information should only come into play once the runners find themselves in deep drek.

The runners may want to get further evidence to back up some of the hot info they hear. For example, while investigating Caspar Rosenberg, they may try to hack into a Boston police database to see if it holds anything on his involvement with the disappearing kids. In these cases, the gamemaster must improvise the system the runners hack into and the information it contains. Generally, this info should not be conclusive; for example, the police database might note that Rosenberg was held for three days of questioning about the disappearances, then released without being charged. The one exception is the Humanis Policlub membership of Rory MacNamara, which may be positively confirmed by consulting an appropriate police database.



CHARACTERS

PATRICK MACNAMARA

Appropriate Contacts (Target Number 4)

Any corporate or media contact, any street contact.

Successes	Result
0	"Doesn't he play urban brawl out in San Diego?"
1	"Yeah, MacNamara, the man of the fraggin' people. Runnin' for mayor of New York as an independent. Looks to be doing OK, too. He's got some nasty right-wing supporters, though—won't get my vote."
2-3	"Mac made his money in the construction industry, and you know what a racket that is. Multi-millionaire now. He's not in the same business these days. I think he's some kind of speculator or something, but he has guys doing that stuff for him."
4+	"His brother, Rory, was a member of the Humanis scumbags in his youth. Mac's always tried to live that one down as youthful indiscretion, but he's never been accused of membership himself."

Hot Information

The runners can only get this information if they *specifically* ask a contact for anything on a possible link between MacNamara and the Mafia. A corporate contact or City Official or a yakuza or Mob contact can supply this information. As with all hot information, raise the Target Number to 8.

Successes	Result
0	"Whoa there! Cement's not my color, you scan?"
1	"Are you <i>sure</i> you have enough nuyen to pay for this? Well, it goes back to his early days in construction. City contract for some satellite suburb ticky-tackies in New Jersey. Mac gave kickbacks to two members of the planning authority, Billy Fitzwalter and Robert Stein, and did a deal with the Gambaccini family, who made sure that no serious alternative contenders came in and took a slice of the pie for themselves. This was back in '39 before the Consortium took over the show. Now I ain't hanging around on this one, chummer, so make sure that credit transfer is where I asked— <i>now</i> . I'm off on vacation for a while."

NATHAIR MACSWEENEY

Appropriate Contacts (Target Number 5)

Any elven or mage contact.

Successes	Result
0	"Come on, is this a joke? Nathair MacSweeney? Pull the other leg, chummer, it's got synchrobells on it."
1	"MacSweeney? Wage mage. I think. Worked in the lower echelons of more than one outfit, strictly small-time. Handled short-term security contracts, then moved on elsewhere. A bit of a wanderer. Never heard anything much about him."
2	"Nat works in New York now, helping that mayoral candidate, MacNamara, with his Irish connections. Adviser on Tír na nÓg, I think. He's not Irish himself, though, I'm sure about that."

Hot Information

Two items of hot info exist on MacSweeney: his membership in the Order of Stars and his distant relationship with Aithne Oakforest. Raise the Target Number to 8 for Etiquette Tests made for this info.

Successes	Result
0	"Null information to date. Can't help you."
1	"Nat spent five years doing hermetic studies at University College Dublin. Became a member of the Order of Stars. Not to be confused with the Order of Sun, Moon, and Stars—the ultra-elite Tír na nÓg shaman-mages, right? Anyway, <i>this</i> order is elves only, and members share hermetic discoveries and learning across many countries—Wales, Tír na nÓg, Tír Taimgire, elven communities all over the place. The Humanis people would have you believe they're plotting world conquest, of course. Don't know about that, but they're pretty secretive and they keep their meetings and exchanges confidential. I know he's workin' for Mac, but if he's over in Tír na nÓg, I'd bet he's doing some <i>extracurricular</i> work too."
2+	"Have I got news for you! You ready for this? Nat's a distant cousin of Mealla Oakforest—wife of Aithne Oakforest, the Tír Taimgire prince. What's more, I got a whisper that Aithne is one of the major movers in linking up elven interests across the world. They're never open about it, of course, especially when it comes to Tír na nÓg. I mean, some people would find that real threatening, given the percentage of magically adept elves in Tír na nÓg. I hear old Aithne is using MacSweeney as an emissary to a Tír na nÓg prince—or do they call 'em stewards over there? Don't know which one, but there's definitely <i>something</i> brewing."

BRIDGIT O'TOOLE

Note: If Padraic is the active character in this adventure, the gamemaster must amend the following information to reflect the change in gender. The target number below applies to non-Tír contacts; if runners make a contact in the Tír, reduce this Target Number to 4.

Appropriate Contacts (Target Number 6)

Any corporate contact.

Successes Result

- 0 "Ain't she a folk singer or something?"
- 1 "Oh yeah, she's part of that Irish company, the transport guys—O'Toole Transcom. I hear she's a real looker and a very sharp businesswoman. Handles the European side of the business."
- 2+ "Bridgit's actually head of the transport division. She's got a brother, Padraic, and a sister, Maire, but her old man's a wily old devil and you can be sure he keeps close tabs on all three of them."

JAMES WASSALL

Appropriate Contacts (Target Number 4)

Any corporate contact (except Security Guard).

Successes Result

- 0 "He runs that new deli by the Italian tailor, don't he?"
- 1 "PR guy, I think. New York-based. He deals with politicians."
- 2+ "Jimmy's a flack for Pat MacNamara, the independent running for mayor of New York. Steady sorta slot. Never heard of any dirt on him."

CASPAR ROSENBERG

Appropriate Contacts (Target Number 4)

Any corporate contact (except Security Guard), City Official.

Successes Result

- 0 "No, wait a minute. *He's* the one who owns that new deli by the Italian tailor. Best cheese fries around."
- 1 "Rosenberg's a political fixer—organizes PR, fundraising events, that kind of thing. Worked up in New England for a time; now he's in the Rotten Apple working for Pat MacNamara."
- 2+ "I've heard Caspar has some skeletons in his closet back in New England. He apparently had links with some weirdo black hermetics or some drek like that. Mind you, a conspiracy freak told me this. But when it comes to politics, who knows?"

Hot Information

Use a Target Number 8 for Etiquette Tests to obtain this information; if the runners get it from Petra Johnson, apply the modifiers listed for her in **When the Smoke Clears**, p. 32, as appropriate. If the runners already have the last piece of information in the preceding table and feed that to a contact for specific checking, reduce the target number by 1. If the runners have a Mob contact, subtract 1 from the target number.

Successes Result

- 0 "Sorry, chummer. No can help you with this one."
- 1+ "Word is, Rosenberg belonged to a pseudo-hermetic group—the Scions of the Rose—that performed some very nasty rituals involving kids. After a rash of disappearing orphans and juveniles back in Boston in 2039, the cops hauled in a bunch of these scions slots for questioning. They never pinned any thing on Rosenberg, but other members of the group got prison sentences of up to 25 years. Buncha sick frags."

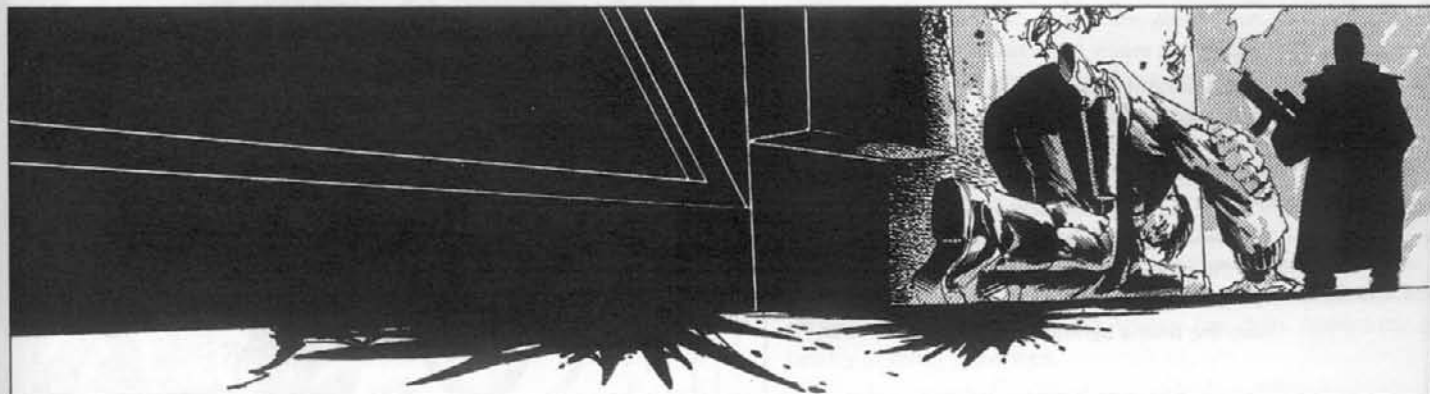

PETRA JOHNSON

Appropriate Contacts (Target Number 4)

Any corporate or media contact.

Successes	Result
0	"Oh, a Ms. Johnson you want? Sorry, chummer, never heard of her."
1	"I think she's a media analyst or some thing—freelancer, works in New York. Said to be a real weirdo but hellishly good."
2+	"Ah yes, Petra. Obsessive-compulsive, chiphead, workaholic, but she's a real wiz—knows all there is to know about most media folks. Wouldn't know a good time if it jumped up and bit her, though. She's been with Mac for a couple of years now, and it shows—he's gonna be the next mayor."

ANTHEA BROWN

Appropriate Contacts (Target Number 4)

Any corporate or media contact.

Successes	Result
0	"Ain't she got a new music trideo out?"
1	"Anthea's a very smart lady. Media manipulator, advertising background. Now she writes speeches for politicos and media geeks."
2+	"Does the scriptwriting for Pat MacNamara, the New York hopeful. Very good at her job. She's a martial arts freak, too. Some slot tried to rape her a few years back. I hear he ain't never going to have kids."

PETER LEWIS

Appropriate Contacts (Target Number 4)

Any media contact.

Successes	Result
0	"Department store, isn't it?"
1	"He's got something to do with media, I think. Some kind of image consultant or style adviser. Very behind-the-scenes kinda guy."
2+	"Yeah, Pete's an adviser to that MacNamara guy in New York. The resident spin doctor. Handles all the opinion polling, media data, and the like. Pete and Anthea Brown, Mac's speechwriter, are the brains behind the campaign, I hear."



Hot Information

Use a Target Number 8 for Etiquette Tests to obtain this info, applying the modifiers noted in **When the Smoke Clears**, p. 32, as appropriate if the runners ask Petra Johnson about Lewis. If the runners have specifically learned from Petra Johnson that Lewis is a chip addict, reduce the target numbers by 2. This hot information can come from a Street Doc contact or possibly a corporate scientist with a medical background, as well as the usual contacts listed above.

Successes	Result
0	"Too hot for me to handle, chummer. Don't wanna get involved."
1+	"Okay, you owe me BIG on this, right? Lewis has been in therapy programs twice trying to get the BTL monkey off his back; the Cooper-Klein clinic, <i>ultra</i> -confidential, right? January to March '47, April to June '50. Still hasn't managed to buck it. This information cost me some <i>real nuyen</i> , you hear? See you real soon, chummer."

XAVIER ALMODOVAR

Appropriate Contacts (Target Number 4)

Company Man, Decker.

Successes	Result
0	"Caught his movie last week, but I never did like that European drek. Couldn't understand a fraggin' word."
1	"Xavier's a greedhead, speculator in commodity markets, I think. Brilliant decker."
2+	"He works for Pat MacNamara in New York. Uses Mac's money to make more money, and he's damn good at it. My sister met him once at a party, but he's got no interest in anything other than money. What a creepy slot. I mean, have you <i>seen</i> my sister?"

ORGANIZATIONS

THE MAFIA

Appropriate Contacts (Target Number 4)

Any Mafia, organized crime, or law enforcement contact.

Successes	Result
0	"The Mafia? Ain't they that new slam band?"
1	"Of course the Mafia's in Ireland—sorry, Tír na nÓg. Not like in the States, of course, or some of the other Euro-nations. Mostly smuggling, black market, BTLs—that sort of drek."
2+	"The Gambaccinis control Mob operations in the Tír. They're very strong on the East Coast of North America too. Very influential, hands in lots of pockets."

SIGNET RING

The mafioso who died at Altan Lodge wore one of these rings, marking him as a capo, or captain, in the Irish Gambaccini family.

Appropriate Contacts (Target Number 6)

Any Mafia, organized crime, or law enforcement contact.

Successes	Result
0	"Sounds shamanic to me, chum. I'd go ask a tree."
1	"That's a Mob signet ring alright. Don't remember whose, though. Very European."
2+	"That's a Gambaccini ring. Marks one of their European VIPs."



ORDER OF STARS

Appropriate Contacts (Target Number 9)

Gamemaster's discretion.

Successes	Result
0	"S'wot I see after three of them Brain Neutralizers down at Griswold's Bar, hur hur."
1	"The Order is a hermetic group; restricted membership, elves only. I think it's based in Europe. That's where most of the members are, anyway. Probably a few in Tír Tairngire as well. Info and resource-sharing group. Nothing conspiratorial about them, not that I've heard."
2+	"They're an oddity—they come across all mystical, but they have some distinctly worldly interests too. Some high-level political contacts are made using the Order as a go-between. So it's not exactly conspiratorial, but they do operate behind the scenes."

Information in the following entries can be accessed in any bulletin board system within the UCAS that handles foreign data. If the runners access this information in the Tír's treuntas database, the entries need slight modifying; the terrorism entry, for example, exhibits substantially more bias in its tone and content in the treuntas database. The three most likely organizations the runners may check out are: Tír na nÓg terrorist groups, O'Toole Transcom, and Sculpted Environmental Systems (which owns Boyle Abbey). Also, the runners may try to learn more about the Order of Stars, which can only be accomplished through appropriate contacts.

TÍR NA NÓG TERRORISM

Tír na nÓg terrorist organizations are either Ulster Protestant terrorists or anti-elves factions from the old, pre-Tír Irish Republican movements.

The Ulster Revolutionary Force (URF) and the New Ulster Revolutionary Movement (NURM) are the major Protestant paramilitary organizations. Both profess the goal of an independent Ulster homeland for the Protestant minority of Tír na nÓg. The URF is the more organized, noted for attacks on government and military targets. Belfast is its major stronghold. The NURM is a more hard-line organization, striking against economic and civilian targets as well as government ones. It has a smaller number of active agents than the URF, and maintains major cells in Derry and the neighborhood of Ballymacarrett in Belfast. The NURM is more openly anti-metahuman than the URF, though the latter organization has broadly anti-metahuman policies. The URF and NURM engage in intermittent bouts of internecine warfare in addition to their actions against the Tír na nÓg government and military. Both groups are active throughout Ulster, but their operations are patchy in other provinces.

Of the old Republican brigades, the Irish Republican Army (IRA) is an anti-elven rule organization with some ork and troll members. It has split into two groups: the Official IRA and the Provisional IRA. Authorities believe both groups maintain active cells in Wexford, Cork, Killarney and Limerick. The Irish National Liberation Army (INLA) is now a terrorist-gangster organization that specializes in organized crime and attacks on civilians.

SCULPTED ENVIRONMENTAL SYSTEMS, INC.

Home Office: Boyle Abbey, Lough Key Forest Park, Connaught
President/CEO: Dominic O'Brien
Chief Products/Services: Ecological research and system development

Corporate Profile

SES Inc. is headquartered in a complex of underground caverns and ground-level buildings scattered throughout Lough Key forest. The Lough Key itself serves as a virtual organic testing ground for SES, which develops plant ecologies that detoxify and alter the acidity of soil, extract trace-minerals, and the like. SES has many foreign customers for its products, and its staff often visit clients to "sculpt" plant eco-systems to meet a client's particular needs.

O'TOOLE TRANSCOM, INC.

Players can consult the public treuntas database for information on O'Toole Transcom. Give them the information listed in that company's corporate profile, p. 60, **Tír na nÓg** sourcebook.



CAST OF SHADOWS

The following NPCs play important roles in **Celtic Double-Cross**. Because they appear more than once in the adventure, their statistics, descriptions, and resources are grouped here for convenience. Descriptions for other, minor NPCs are given in the encounters where they appear.

NATHAIR MACSWEENEY

MacSweeney is 32 years old, well over two meters tall, with curly auburn hair and greenish-gray eyes. A distant cousin of Mealla Oakforest, Prince Aithne Oakforest's wife, he was born in Nevada but undertook hermetic studies at University College, Dublin, from 2040 to 2045. After returning to the UCAS, he worked in a number of innocuous corporate-mage jobs until a small CSP head-hunting firm picked him up in 2049. He has been part of MacNamara's entourage since January 2051.

MacSweeney is a "sleeper" agent for the interests of Tír Tairngire. Aithne Oakforest paid for his studies in Dublin in exchange for MacSweeney's reports on the rising corporate stars and politicians who employ him. MacSweeney has reported that MacNamara is a dangerous, anti-metahuman racist, and so for the first time his Tír Tairngire contacts have involved him in a plan to discredit MacNamara by exposing his affiliations with the Mafia. As a sideline, MacSweeney is preparing the ground for some preliminary negotiations between Aithne Oakforest and Dominic O'Brien, a member of Tír na nÓg's Council of Stewards.

MacSweeney is a Grade 3 initiate of the Order of Stars, an elven hermetic order based in Tír na nÓg. More details about MacSweeney and this group are covered in **Legwork**, p. 61.

MacSweeney drinks little and appears a studious but politically aware individual. Cool and controlled, he never loses his temper. Although he is not a Tír na nÓg subject, he subscribes to the basic belief system of the Tír na nÓg Danaan-mór concerning reincarnation and the special status of the elven race (see p. 65, **Tír na nÓg**), and regards it as an almost sacred duty to advance elven interests across the world.

Attributes

Body: 2
 Quickness: 4
 Strength: 2
 Charisma: 5
 Intelligence: 6
 Willpower: 4
 Essence: 6
 Magic: 9
 Reaction: 5



Initiative: 5 + 1D6

Threat/Professional Rating: 7/4

Skills

Conjuring: 7
 Etiquette (Politics): 3
 Firearms: 2
 Languages
 Gaelic: 5
 Sperethiel: 5
 Magical Theory: 7
 Negotiation: 4
 Psychology: 3
 Sorcery: 7

Grade of Initiation: 3

Gear

- Armor Jacket (4/3)
- Computer Media Hermetic Library:
 - Conjuring: 6
 - Magical Theory: 5
 - Sorcery: 4
- Data Display with 200Mp of memory
- Power Focus (3)
- Remington Roomsweeper [Heavy Pistol, 8 (magazine), SA, 9S(f)]
- Spell Category Focus: Manipulation Spells (3)

Spells

Combat

- Fireball: 6
- Sleep: 6
- Mana Bolt: 6

Health

- Heal Severe Wounds: 4
- Increase Attribute: +2.5

Illusion

- Chaos: 5

Metamagic

Nathair uses recitation in Gaelic-Sperethiel as his medium for metamagic. When circumstances require, he uses his masking ability to excellent effect.

Note: Nathair's Spell Category Focus adds bonus dice to Spell Resistance Tests, but not to Success Tests or Drain Resistance Tests made when casting manipulation spells. The focus, a small wedge of sandstone engraved with Celtic symbols, gives him an edge in resisting control spells.

		CONDITION MONITOR			
		LIGHT STUN	MODERATE STUN	SERIOUS STUN	DEADLY STUN
STUN	+1 TN#	+2 TN#	+3 TN#		Unc.
	-1 Init.	-2 Init.	-3 Init.		
PHYSICAL	+1 TN#	+2 TN#	+3 TN#		Unc. maybe dead
	-1 Init.	-2 Init.	-3 Init.		
		LIGHT WOUND	MODERATE WOUND	SERIOUS WOUND	DEADLY WOUND

BRIDGIT O'TOOLE

Note: The statistics and general background below may be used for Padraic O'Toole if he becomes the important contact for the runners. Adjust minor details accordingly.

Bridgit O'Toole is the 24-year-old daughter of Seamus O'Toole, president and CEO of O'Toole Transcom (OTT). Division head of O'Toole Transport Systems, she is tall for a woman, breathtakingly beautiful, and always dressed in the latest fashions.

Bridgit has been educated for her corporate role ever since her early years. She has traveled widely across Europe, and her days in Paris, Vienna, Venice, and elsewhere have left her cultured and knowledgeable. However, Bridgit is easily bored. She enjoys excitement and unpredictability, both of which are generally in short supply in her life. Her social situation and riches make everything too easy for her. Bridgit is also a dominant and fiercely proud individual, fully capable of swift responses to any situation. She lives in a penthouse suite off Chichester Street in central Dublin.

Bridgit will not countenance any actions that may harm her family, company, or the well-being of Tír na nÓg. In dealing with her later in the adventure, runners must act aware of these sensitivities and plan their requests for help accordingly. When socializing with Bridgit, runners must show awareness of social decorum.



Attributes

- Body: 3
- Quickness: 6
- Strength: 2
- Charisma: 7
- Intelligence: 6
- Willpower: 5
- Essence: 5
- Reaction: 6

Initiative: 6 + 1D6

Threat/Professional Rating: 5/2

Skills

- Car: 4
- Computer: 4
- Electronics: 4
- Etiquette: 8
- Languages
 - French: 6
 - German: 6
 - Italian: 6
 - Spanish: 6
- Leadership: 7
- Motor Boat: 5
- Negotiation: 8
- Winged Planes: 5

Gear

Unlimited Tres Chic clothing

Note: Assume that Bridgit has virtually unlimited cash at her disposal. As part of her work, she is surrounded by all the electronics, computers, and equipment her position requires. See **When the Smoke Clears**, p. 32, for details of the equipment to which she has access.

CONDITION MONITOR				
	LIGHT STUN	MODERATE STUN	SERIOUS STUN	DEADLY STUN
STUN	+1 TN# -1 Init.	+2 TN# -2 Init.	+3 TN# -3 Init.	Unc.
PHYSICAL	+1 TN# -1 Init.	+2 TN# -2 Init.	+3 TN# -3 Init.	Unc. maybe dead
	LIGHT WOUND	MODERATE WOUND	SERIOUS WOUND	DEADLY WOUND

PETRA JOHNSON

Petra Johnson is 28 years old. A petite, thin woman with platinum blonde hair, she dresses conservatively. She chain-smokes silver-banded black cigarettes, and her hotel room always has a bottle of iced vodka lying around somewhere. Though neurotic and highly strung, Petra exhibits great self-control when dealing with the media. She specializes in media law, and has built

up a superb library of profiles of virtually every major journalist and media company in the UCAS. That makes her invaluable to MacNamara and Anthea Brown.

Petra feels neglected, undervalued, miserable, and lonely, which makes dealing with her tricky. In the later stages of the adventure, runners may best deal with her by projecting a sense of confidence, no matter how desperate things actually become. As long as the runner shows no panic or desperation, Petra takes direction well.

Petra *hates* being called "Ms. Johnson." It makes her sound like a corporate fixer.



Attributes

- Body: 2
- Quickness: 4
- Strength: 3
- Charisma: 3
- Intelligence: 6
- Willpower: 4
- Essence: 0.2
- Reaction: 5 (7)*

Initiative: 5 (7 when in the Matrix) + 1D6 (3D6 when in the Matrix)

Threat/Professional Rating: 2/3

Skills

- Car: 4
- Computer: 6
- Computer (B/R): 4
- Computer Theory: 4
- Electronics: 4
- Etiquette (Corporate): 5
- Etiquette (Media): 6
- Etiquette (Politics): 6
- Unarmed Combat: 2

Special Skill

- Law (Media): 7

Cyberware

- Datajack
- Headware Memory w/350 Mp
- Data Filter
- Data Lock
- Display Link
- Head Telephone
- Retractable Razors

Gear

- Ares Predator [Heavy Pistol, 15 (clip), SA, 9M]
- Fuchi Cyber-6 (with Response Increase 2 and optical disk interface)
- Programs
 - Analyze: 7
 - Attack: 5
 - Bod: 5
 - Browse: 7
 - Deception: 4
 - Evasion: 4
 - Masking: 4
 - Sensors: 6
- Microtronics Workshop: Table-top personal computer (250 Mp)
- Optical Disc Library (media/journalists), 2000 Mp total (in secure deposit box)
- Portable vidphone

MAIRTIN O'NEILL

Mairtin O'Neill is the Tir Republican Corps officer (oifigeach), responsible for investigating the events at Altan Lodge. O'Neill is 28 years old, some two meters tall, and strongly built, with thick brown hair and pale blue eyes. An extremely efficient and commanding leader of his men, he does not risk their lives needlessly. As a member of the Reach Fuileach, the elite assassins of the TRC, O'Neill is a powerful and dangerous elf.

O'Neill is uncertain about the events at Altan Lodge. He has been told that dangerous foreign criminal elements with Mafia links are still on the loose and his job is to neutralize them. Normally this would amount to a hit order. If the runners act aggressively toward his men, he will kill them. However, because the runners are foreigners (not the usual Tir terrorists), he is curious about them and prefers to take at least some of them alive for interrogation. As a result, he is prepared to accept surrender from the runners even after hostilities have broken out.

O'Neill is a Grade 2 initiate of the Order of Cu Chulainn, and also a physical adept.



		CONDITION MONITOR			
		LIGHT STUN	MODERATE STUN	SERIOUS STUN	DEADLY STUN
STUN	+1 TN#	+2 TN#	+3 TN#		Unc.
	-1 Init.	-2 Init.	-3 Init.		
PHYSICAL	+1 TN#	+2 TN#	+3 TN#		Unc. maybe dead
	-1 Init.	-2 Init.	-3 Init.		
		LIGHT WOUND	MODERATE WOUND	SERIOUS WOUND	DEADLY WOUND

Attributes

Body: 5
 Quickness: 7 (9)
 Strength: 4 (6)
 Charisma: 3
 Intelligence: 4
 Willpower: 3
 Essence: 2.28
 Magic: 8
 Reaction: 5 (7) + 1D6 (3D6)

Initiative: 5 (7) + 1D6 (3D6)

Threat/Professional Rating: 7/4

Skills

Armed Combat: 6
 Bike: 4
 Etiquette (Military): 6
 Etiquette (Street): 3
 Firearms: 7
 Interrogation: 4
 Magical Theory: 3
 Psychology (Deviant Behavior): 4
 Sorcery: 6
 Throwing Weapons: 3
 Unarmed Combat: 4

Cyberware (all Beta-customized)

Boosted Muscles (2)
 Boosted Reflexes (3)
 3 Chipjacks
 Morph-analyzing Rangefinder
 Smartlink

Gear

AET NN-12 [Heavy Pistol, 25 (clip), SA, 9S(f), w/extra clip and Internal Smartlink]
 AET Beithir Sniper Rifle [Rifle, 10 (magazine), SA, 14S, with morph-analyzing rangefinder]
 Ares Narcoject Rifle [Shotgun, 10 (clip), (see note below for damage), w/extra clip]
 Bug Scanner
 Cu Chulainn Armor (6/4)
 Enfield AS-7 [Shotgun, 10 (clip), SA/BF, 8S, w/10 APDS rounds]
 Harley Electraglide-1000 Patrol Cycle (see stats below)
 Respirator
 Restraints (4)
 Spell Lock (Detect Life/4 successes)
 Spell Lock (Mind Probe/4 successes)

Adept Powers

Combat Sense (1)
 Improved Physical Attribute (Body +2)
 Improved Physical Senses: Hi/Low Frequency Hearing, Flare
 Compensating Vision, Thermographic Vision
 Killing Hands [3(5)S]
 Pain Resistance (2)

Metamagic

Mairtin uses a ritual wardance for metamagic.

Note: Ares Narcoject Rifle delivers one dose of narcoject toxin (6D Stun). Resolve using standard Ranged Combat procedure; however, roll only Combat Pool dice against the target number (reduced by impact armor). If the target does not generate more net successes than O'Neill, make a Body Test against the toxin to reduce its effect. For this test, impact armor and Combat Pool dice do not apply.

		CONDITION MONITOR			
		LIGHT STUN	MODERATE STUN	SERIOUS STUN	DEADLY STUN
STUN	+1 TN# -1 Init.	+2 TN# -2 Init.	+3 TN# -3 Init.	Unc.	Unc.
	+1 TN# -1 Init.	+2 TN# -2 Init.	+3 TN# -3 Init.	Unc. maybe dead	Unc. maybe dead
		LIGHT WOUND	MODERATE WOUND	SERIOUS WOUND	DEADLY WOUND
PHYSICAL	+1 TN# -1 Init.	+2 TN# -2 Init.	+3 TN# -3 Init.	Unc. maybe dead	Unc. maybe dead
	+1 TN# -1 Init.	+2 TN# -2 Init.	+3 TN# -3 Init.	Unc. maybe dead	Unc. maybe dead

Harley Electraglide-1000 Patrol Cycle

Handling	Speed	B/A	Signature	APilot
1 + 1	3/4	95/285	3/2	2

Seating: 1

DOMINIC O'BRIEN

Dominic O'Brien is the president and CEO of Sculpted Environmental Systems, Inc. (SES) of Tir na nÓg. O'Brien also sits on the Council of Stewards. Although only 41 years of age, Dominic is grave and quiet, a highly regarded druidic initiate of the Order of Ogma (Grade 8). Dominic dislikes public appearances and prefers to stay in his own laboratories. He cuts an authoritative figure in his ritual regalia.

A powerful elf within Tir na nÓg, O'Brien is unusual in that he seeks links with elven nations and factions worldwide. He is receptive to the overtures of Aithne Oakforest, but also aware of the need to keep these confidential.

Full rules for Druidic initiates of the Order of Ogma appear on p. 138 of the **Tir na nÓg** sourcebook. Though O'Brien abhors violence, he uses his considerable magical skills to full effect if threatened.

Attributes

Body: 4
 Quickness: 4
 Strength: 3
 Charisma: 8
 Intelligence: 6
 Willpower: 7
 Essence: 6
 Magic: 13

Initiative: 4 + 1D6

Threat/Professional Rating: 7/3

Skills

- Armed Combat: 3
- Staff: 5
- Biology: 4
- Botany: 7
- Parabotany: 8
- Parazoology: 7
- Zoology: 6
- Conjuring: 9
- Enchanting: 10
- Geology: 5
- Magical Theory: 8
- Psychology: 5
- Sorcery: 9
- Swimming: 5
- Unarmed Combat: 4

Special Skills

- Law: 7
- Law (Brehon): 9
- Literary History (Tír na nÓg): 7
- Magical Theory (Danaan): 10

Gear

- Power/Spirit Focus (5/5)
- Ritual regalia of Order of Ogma (Armor Rating 3/2)
- Unique Focus: golden cauldron capable of projecting the equivalent of the critter powers of Enhanced Physical Attributes, Movement and Weather Control (Drain Code is 6L for each use of this item by the druidic magician).
- Weapon Focus (Staff) (4)

Spells

Detection

Personal Analyze Truth: 8

Illusion

- Chaotic World: 7
- Confusion: 8
- Improved Invisibility: 7
- Mask: 9
- Overstimulation: 7

Metamagic

Dominic recites verses from *The Book of Invasions* in Gaelic-Sperethiel as his medium for metamagic.

Notes: As a druidic initiate, O'Brien has many special advantages. Add a +2 modifier to all target numbers for tests when attempting to penetrate any form of masking or invisibility spells he employs. O'Brien also gains 4 bonus dice (half his Initiate Grade) when casting illusion spells, and an additional bonus die for casting *any* form of spell as long as he is in Connaught. He subtracts 1 die when making Resistance Tests against combat spells.

Dominic can conjure any form of elemental, but has the following advantages with water elementals: apply a -1 modifier to target numbers for Conjuring Tests, reduce times required by 10 percent, and add +1 to successes rolled and to services given. When summoning earth elementals, reverse all benefits for water elementals; also, he cannot summon the elemental's Great Form. O'Brien can also summon spirits of the waters, but no other nature spirit type.

Other bonuses may apply due to season and the like; see p. 134. **Tír na nÓg**, for details.



From the desk of

JAMES WASSAL

To: Security Operatives

Re: Tour Itinerary

DAY 1

10:00 A.M. EST: Arrive John F. Kennedy Airport for briefing.

12:00 P.M. EST: Orbital flight departs JFK.

8:00 P.M. GMT: Arrive Shannon International Airport. Party met by Tir government officials. Customs checks.

8:30 P.M. GMT: Depart Shannon Airport by private jet.

9:00 P.M. GMT: Arrive Dublin International Airport. Party met by President William O'Dunn and other government officials. Motorcade proceeds to Flathail Hotel, Fitzwilliam Street. Drinks in hotel suites with selected guests.

(We have the fifth floor booked as a group, including the James Joyce and Mary Margaret O'Hara suites, for meetings. Your accommodations are in the west wing; please check with hotel reception for room details and keys. You will dine separately from the rest of the party.)

DAY 2

7:30 A.M. GMT: Breakfast with representatives of the Dublin Chamber of Commerce, Flathail Hotel. (SECURITY OPERATIVES NOT REQUIRED.)

9:15 A.M. GMT: Motorcade departs from Flathail for tour of assorted cultural sites of interest.

(The exact details may be subject to last-minute changes, but the National History Museum, Trinity College, and Leinster House are certainties.)

12:00 P.M. GMT: Lunch and reception for Seamus O'Toole and executives of O'Toole Transcom at the Flathail Hotel.

2:00 P.M. GMT: Motorcade departs for visit to the De Valera Habitat of Renraku Éireann-Tir at Dun Laoghaire. Discussions with Renraku executives. (SECURITY OPERATIVES NOT REQUIRED.)

(Please note that Renraku have arranged their own security with the Tir government and active surveillance on your part is not required.)

5:30 P.M. GMT (approx): Party returns to Flathail Hotel (ETA 18:00).

7:00 P.M. GMT: Dinner/reception for Dublin business people, Flathail Hotel. (SECURITY OPERATIVES NOT REQUIRED.)

(The representatives will have their own security arranged with the government. You may spend this time as you wish, but please be outside Bloduedd's PROMPTLY at 8:30 P.M. GMT for preparatory surveillance.)

9:00 P.M. GMT: Reception for prominent Tir businessmen, media personalities, and artists, Bloduedd's Night Club and Restaurant.

(Make sure your presence is discreet in and outside the building. Those entering Bloduedd's must be suitably attired. Unfortunately, NO TROLLS, ORKS, OR DWARFS ARE TO ENTER BLODUEDD'S.)

Limousines will be available to return party members to the Flathail from 11:30 P.M. on. Please do not cease surveillance until Mr. MacNamara has returned to the hotel.

DAY 3

7:30 A.M. GMT: Family breakfast for members of the MacNamara family living in the Tir. (SECURITY OPERATIVES NOT REQUIRED.)

10:30 A.M. GMT: Motorcade and meet-the-people walkabout.

(This is the perennial nightmare. The motorcade's exact route depends on advice from the Garda, but we shall stick close to major streets in Dublin. BE VIGILANT. This is the most risky event of the visit.)

12:00 P.M. GMT: Luncheon with the Mayor of Dublin, the Worshipful Graeme Patrick Finnegan, and members of the Dublin City Corporation, Dublin Castle.

2:00 P.M. GMT: Meeting and discussion with members of the Leinster Assembly, Dublin Castle. (SECURITY OPERATIVES NOT REQUIRED.)

(The Tir government will handle security at this location and your attendance is not required. However, be outside the offices of Éireann-Tir Tours PROMPTLY at 3:00 p.m. for preparatory surveillance.)

4:00 P.M. GMT: Trade talks at the offices of Éireann-Tir Tours with directors of O'Toole Transcom.

(Once everyone is inside the building, Tir security will handle matters. We don't need you here, but REMAIN WITHIN FIVE MINUTES' TRAVEL DISTANCE OF THIS BUILDING because we may wish to make an "impromptu" visit to the DART rail system for a photo-

opportunity and, if we do, we will require your attendance. In any event, be outside this location by 6:30 p.m. to accompany the entourage back to the Flathail.)

6:45 P.M. GMT (approx): Return to Flathail Hotel.

7:30 P.M. GMT: Motorcade leaves for a dinner with invited guests at Dublin Castle. Following dinner, the Order of Brigid performs musical and poetic entertainments, including a performance of Doncha O'Brien's play, *The Destiny of Ages*.

(We require no security in the castle, but you will be permitted to dine and observe the cultural events. PLEASE BE SURE TO DRESS SMARTLY AND BEHAVE WITH DUE DECORUM AT ALL TIMES.)

11:00 P.M. GMT (approx): Motorcade returns to the Flathail for nightcaps and minor entertainments in hotel suites with select group of invited guests.

(Please be sure to make your surveillance ESPECIALLY discreet. Surveillance may cease 30 minutes after Mr. MacNamara has retired for the night, unless Mr. Rosenberg or I advise otherwise.)

DAY 4

7:30 A.M. GMT: Breakfast for selected guests at the Flathail. (SECURITY OPERATIVES NOT REQUIRED.)

9:30 A.M. GMT: Motorcade leaves for Dublin Airport for private jet to Wexford Airport.

10:45 A.M. GMT: Walkabout at entrance to John F. Kennedy Memorial Park.

(Garda and TRC security will be strong but at a distance to allow for consumer-friendly photo-ops. BE VIGILANT.)

11:15 A.M. GMT: Guided tour of the JFK Memorial.

12:45 P.M. GMT: Luncheon at the Robert Kennedy Lodge with invited guests.

2:30 P.M. GMT: Guided tour of the Genealogy Exhibition with members of the MacNamara family.

(This is vital to our PR effort. Mr. MacNamara will be able to find conclusive evidence of historic Irish ancestry, accompanied by his cousins and other Tir relatives. THIS IS A MAJOR PHOTO-OPPORTUNITY AND SECURITY MUST COMBINE VIGILANCE WITH AN ULTRA-LOW PROFILE AT ALL TIMES.)

5:00 P.M. GMT (approx): Depart John F. Kennedy Memorial Park for Wexford Airport, then by private jet to Shannon International Airport and the Inter-Tir Hotel.

6:30 P.M. GMT: Dinner. (SECURITY OPERATIVES NOT REQUIRED.)

6:00 P.M. GMT: Confidential business meeting with representatives of Connaught business, provisionally at Inter-Tir Hotel.

(Your presence may not be required here. I will confirm later.)

DAY 5

9:00 A.M. GMT: Motorcade departs for tour of sacred sites at Knocknarea and Rathcroghan, attended by members of the Order of Ogma.

12:30 P.M. GMT: Lunch at Roscommon Castle as guests of taoiseach Martin O'Connor.

(This function will not be attended by our security operatives, who will remain outside the castle grounds.)

3:00 P.M. GMT: Depart by helicopter to Shannon International Airport.

4:00 P.M. GMT: Depart by orbital flight to JFK Airport, New York.

Midnight (approx): Arrival at JFK Airport.

DUBLIN

Downtown Area

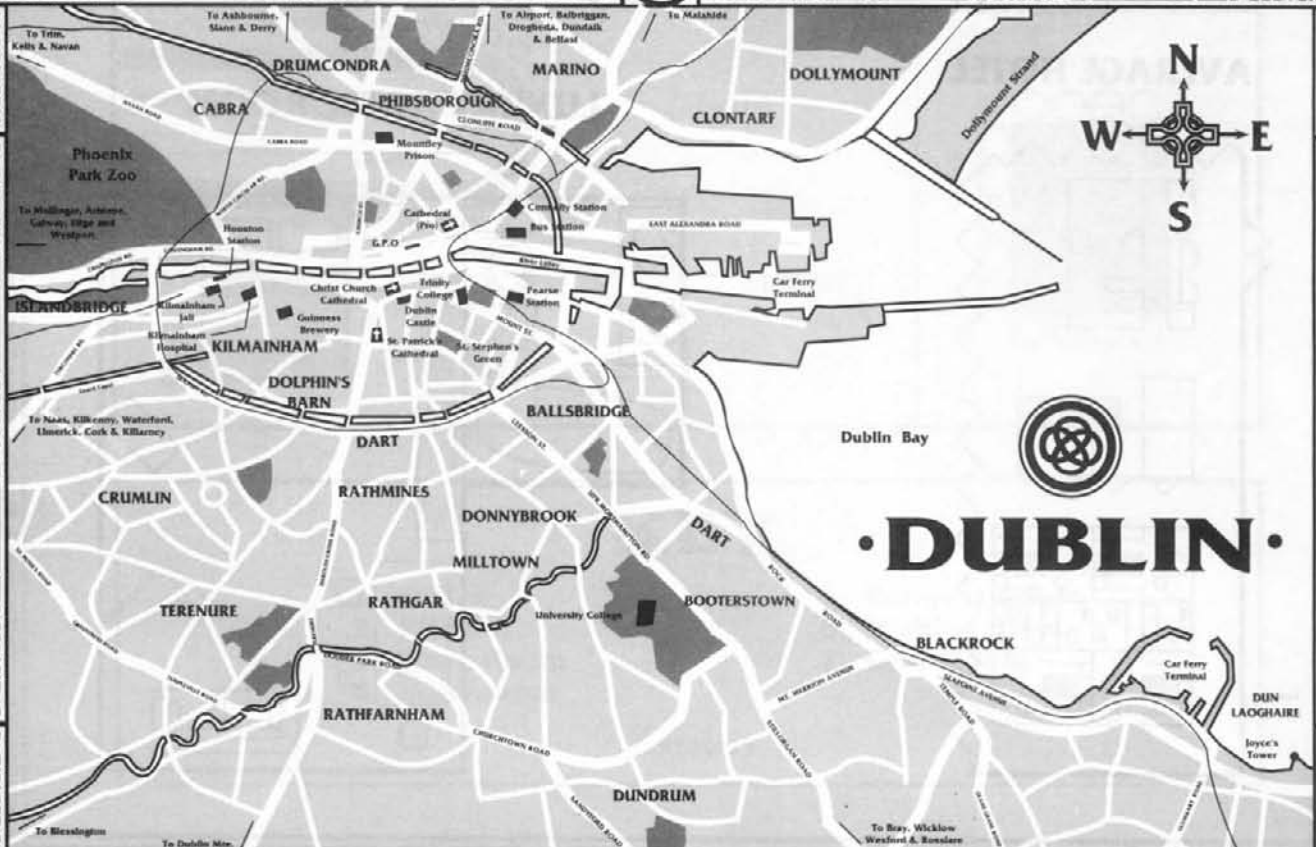

LUXURY HOTEL (Section of Lobby)

2 Meters

- 1. Gift Shop
- 2. Bar
- 3. Front Desk

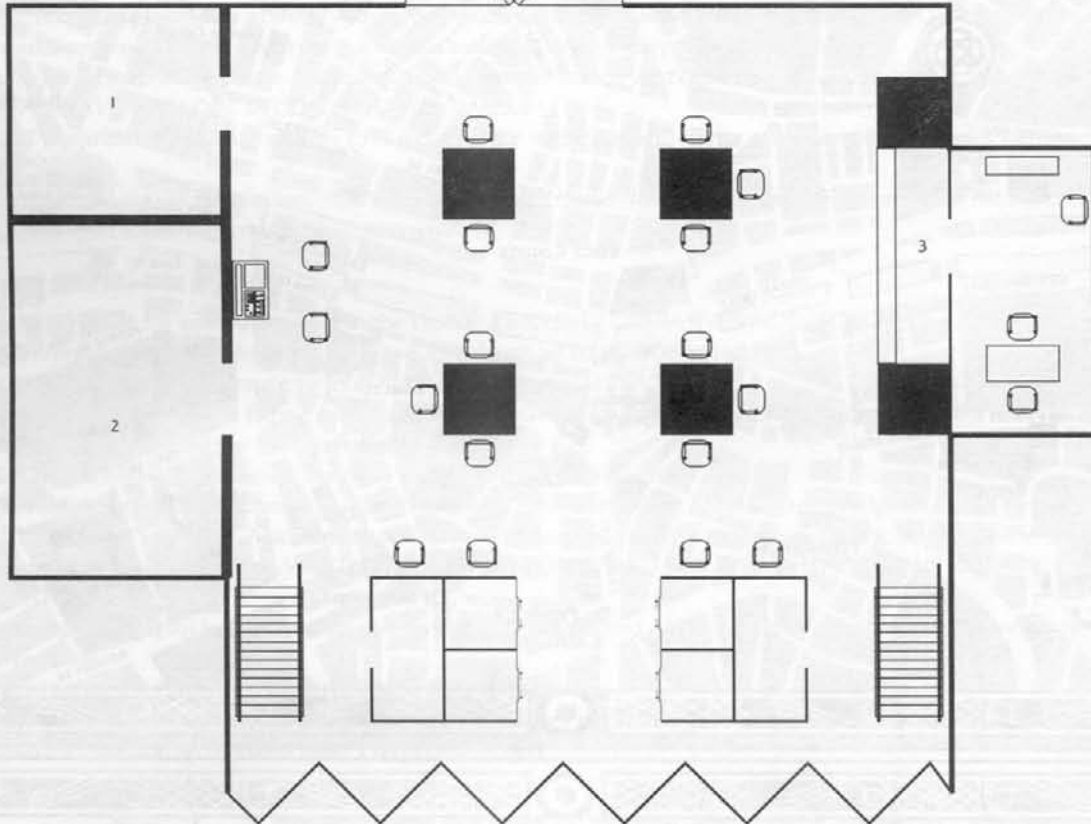

AVERAGE HOTEL

2 Meter

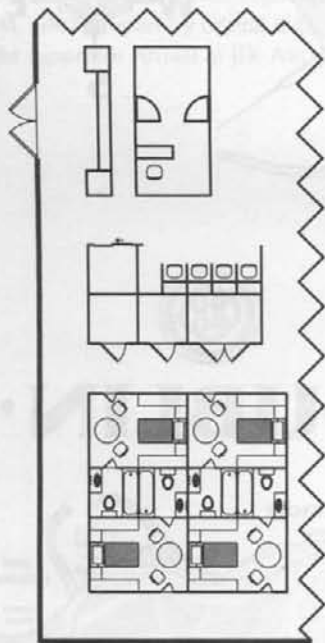

LUXURY HOTEL ROOM

1 Meter

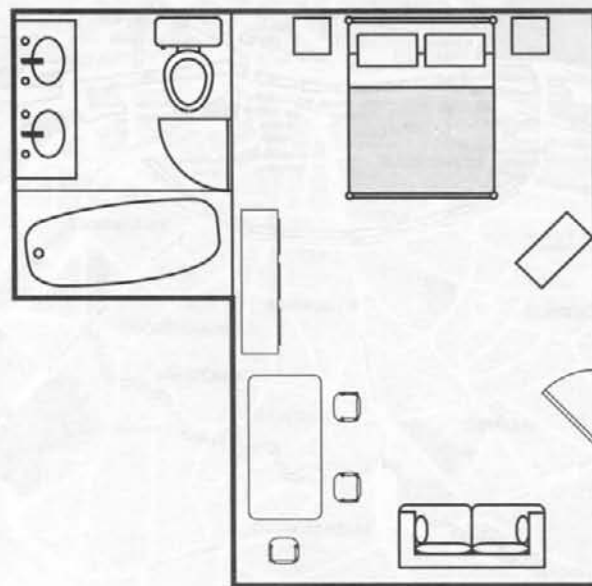

LARGE RESTURANT

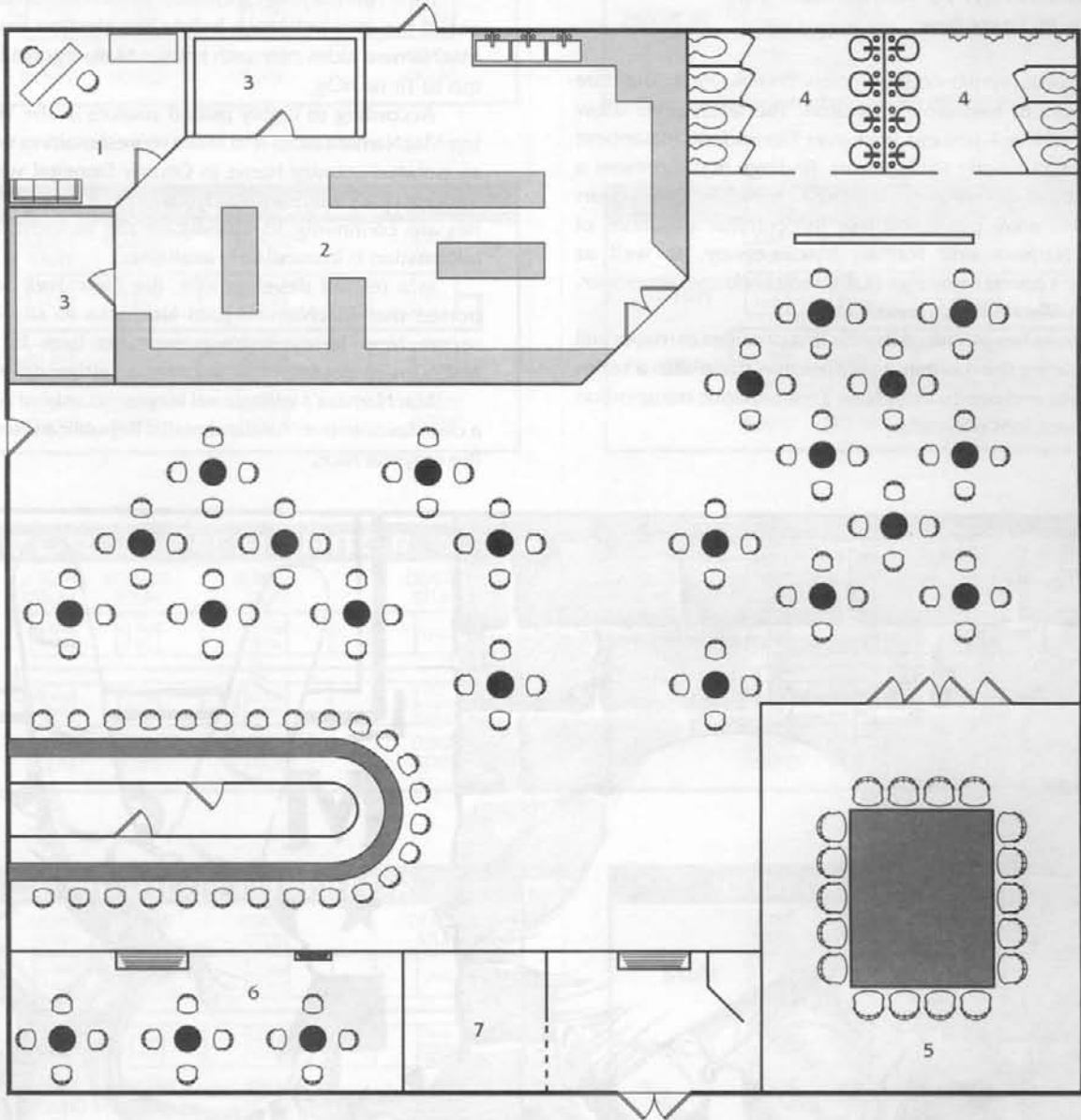

KEY

- 1. Office
- 2. Kitchen
- 3. Store Room
- 4. Washroom
- 5. Banquet Room
- 6. Waiting Area
- 7. Coat Room

—|—
2 Meters

PLAYER HANDOUT #4

If the runners cut a deal with MacNamara, give them this to read:

OPINION POLLS POINT TO MacNAMARA WIN
C. Sargent & M. Gascoigne

Opinion polls predict victory for New York mayoral candidate Pat MacNamara in tomorrow's election. The latest polls show MacNamara with a 7 percent lead over Democratic incumbent Andrew T. Small among likely voters, findings that represent a remarkable comeback for the beleaguered candidate. Only weeks ago, observers were predicting that the criminal affiliations of former MacNamara aide Nathair MacSweeney, as well as MacSweeney's covert campaign to discredit his former employer, would doom MacNamara's candidacy.

MacNamara has promised that his first priorities as mayor will be re-invigorating the moribund construction trade with a series of public works and overhauling New York's chaotic transportation and communications networks.

For any other outcome, give the players this to read:

MACNAMARA CAMPAIGN IN RUINS
C. Sargent and M. Gascoigne

New York mayoral candidate Patrick MacNamara has dropped out of the race only days before the election amid reports that MacNamara aides met with known Mafia figures during a recent trip to Tír na nÓg.

According to highly placed sources in the Tír government, top MacNamara aides and Mafia representatives were meeting in an isolated country home in County Donegal when they came under attack from terrorists. According to Tír spokesmen, authorities are continuing to investigate the incident, but no further information is immediately available.

In a related development, the *New York Sentinel* has reported that MacNamara paid kickbacks to city councilmen to secure New Jersey building contracts back in the late '30s. MacNamara declined to comment on either development.

MacNamara's withdrawal leaves incumbent Andrew T. Small a clear favorite over fundamentalist Republican Norbert Quayle in the mayoral race.

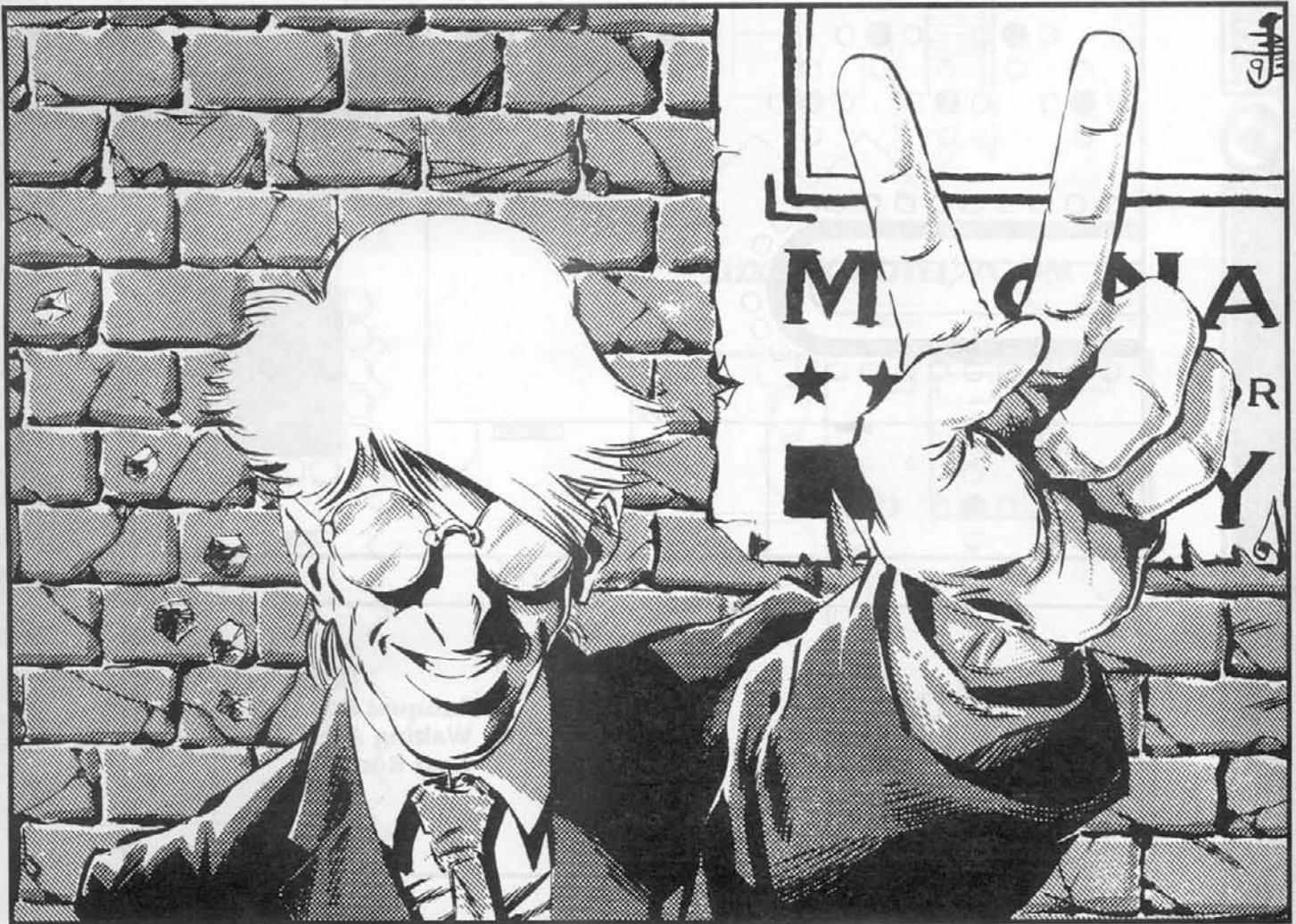



SHADOWRUN NETWORK

>>>>(Slot & run, chummer.)<<<<

You're busy. Staying alive in the sprawl is a full-time job, so we'll make it quick. You need to jack into the Shadowrun Network®, the only org licensed by FASA to give you what you need: the latest news, info and rumors from the streets of 2053.

>>>>(What's my cut?)<<<<

You want a pretty certificate? Go join a corp. We're not some drekky little fan club. We're a network, with an accent on the work. For your donation of \$20.00 (S&H can be extra), you get four issues of our quarterly newsmagazine, **KA•GE™**. **KA•GE™** is 48 pages of chiptruth that covers the streets from every angle, whether you want magic, matrix, or Mossberg. We give you fiction, new gear, spells, contacts and archetypes, all wrapped around a tough scenario. You'll also get the hottest paydata on FASA's new products, long before they hit the streets.

>>>>(Cut to the chase.)<<<<

For your twenty bucks you get:

- Four 48 page issues of Ka•ge with:
 - Access to restricted FASA information
 - Stats on more & better tools of the trade
 - New contacts
 - New archetypes
 - New locations w/ Maps
 - Product Reviews
- New Scenarios
- Convention Information
- New Fiction
- The chance to have your own artwork and prose published!

(Please use a pen and print clearly)

Name: _____
 Street Address: _____
 City: _____ State: _____ Zip: _____
 Phone: _____

This is a...(Check one)

- New Membership Renewal
 ...If Renewal, list Membership # _____
- Full Membership \$20.00
- In order for Ka•ge to reach me I'll need...
- US 1st Class postage Included
 Canada/Mexico 1st Class postage \$4.00
 Overseas 1st Class postage \$6.00
- Total amount included \$ _____

Make all Checks/Money Orders payable to

SHADOWRUN NETWORK®
AND IN UNITED STATES DOLLARS ONLY



Mall to:
AWOL Productions
2101 West Broadway #305
PO Box 6018
Columbia, MO 65205-6018



CELTIC™ DOUBLE-CROSS

RENOWNED
AS A LAND OF WONDERS,
TÍR NA NÓG BRIMS WITH ANCIENT ELVEN ART AND
SOPHISTICATED ELVEN NOBLES, POWERFUL MAGIC
AND CUTTING-EDGE TECHNOLOGIES.
BUT BENEATH THIS CULTURED FACADE
LIES A DARK MIX OF
LONG-SIMMERING FEUDS
AND MACHIAVELLIAN PLOTS.
NOW ADD A DASH OF GOOD OLD UCAS POLITICS,
AND YOU HAVE A BYZANTINE BREW OF
BETRAYAL AND BLOODSHED,
A MICKEY FINN WITH A LETHAL KICK.

CELTIC DOUBLE-CROSS IS A SHADOWRUN ADVENTURE
FOR ADVANCED PLAYERS AND GEMEMASTERS.
IT IS COMPATIBLE WITH BOTH SHADOWRUN, SECOND EDITION RULES
AND THE ORIGINAL FIRST-EDITION RULES.
THE TÍR NA NÓG SOURCEBOOK IS REQUIRED FOR PLAY.

 SHADOWRUN®

SHADOWRUN® is a registered Trademark of FASA Corporation.
Celtic Double-Cross™ and Tír na nÓg™ are Trademarks of
FASA Corporation. Copyright © 1993 FASA Corporation.
All rights reserved. Printed in the U.S.A.

 FASA
CORPORATION

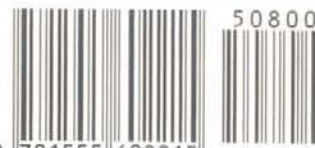

9 781555 602215

ISBN 1-55560-221-5 8.00